

AXUS LONG CASED AXIAL FANS

A MASSIVE RANGE OF HIGH PERFORMANCE
AXIAL FANS TO SUIT EVERY APPLICATION.



BENEFITS

WIDE RANGE

The widest range of 'standard' axials available. A fan to match every application ensures maximum efficiency saving costly energy.

ENERGY EFFICIENT

The fan impeller and IE2 motors provide the most efficient solution.

LONG LIFE HEAVY GAUGE GALVANISED STEEL CONSTRUCTION

Ensures strength, durability and protection from damage during installation and will be corrosion resistant.

TESTED TO THE HIGHEST STANDARDS

Air performance to BS848 (part 1) 2007 and ISO5801 (part1) 2007 with acoustic performance to AMCA300. All carried out at Nuair's test facilities to ensure the most accurate performance figures and noise data is provided, constantly monitored to give you up to date information you can rely on.

CONTROLS

Wide range available including energy efficient Ecosmart.

COMPREHENSIVE ANCILLARIES

Including attenuators, speed controls and mounting ancillaries all pre-selected for the individual fan to ensure a perfect match and eliminate any on-site fitting problems.

FAN OPTIONS

As well as long cased axials, Contra-rotating, Run/standby listed, options within the Axus range (2 speed-operation half and full. Flameproof motors to EExd IIBT4.

STOCK AVAILABILITY

Stock range available on 'next day' delivery. Standard products give peace of mind when designing those 'rapid turnaround' projects - contact Nuair for delivery dates.

WARRANTY

Axus has a 3 year warranty. Ecosmart Axus has a 5 year warranty.

ANCILLARIES FOR AXUS LONG CASED AXIAL FANS



Mounting Brackets (pair)
 Typical Code: CMB25



Matching Flange (single)
 Typical Code: CMF25



Flexible Connector (Single)
 Typical Code: CFC25



Anti-Vibration Mounts (for fan only)
 Codes: See Tables



Acoustic Jacket
 Typical Code: ACJAC250



Attenuator (standard, long and podded options). Typical Code: CA25S



Guard
 Typical Code: CGD25



Inlet Cone
 Typical Code: CIC25



Backdraught Damper
 Typical Code: CBD25



Speed Controls/Inverters
 Refer to end of Axial section

Note: individual ancillary code numbers for each fan size are included on page 310.

CASE OPTIONS

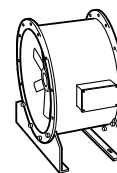

AXUS Circular Axial.

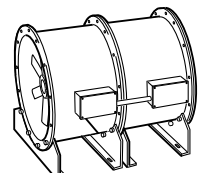

AXUS Contra-Rotating.

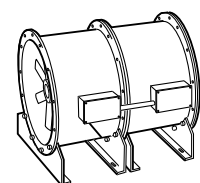

AXUS Run & Standby.

AXIAL FANS

AXUS LONG CASED

TECHNICAL INFORMATION

DUTY RANGE - AXUS LONG CASED AXIAL UNITS

Below is an indication of the overall duty range, a selection of which is covered in this brochure. Please contact Nuair (029) 20 858 200 for any duty outside the range indicated.

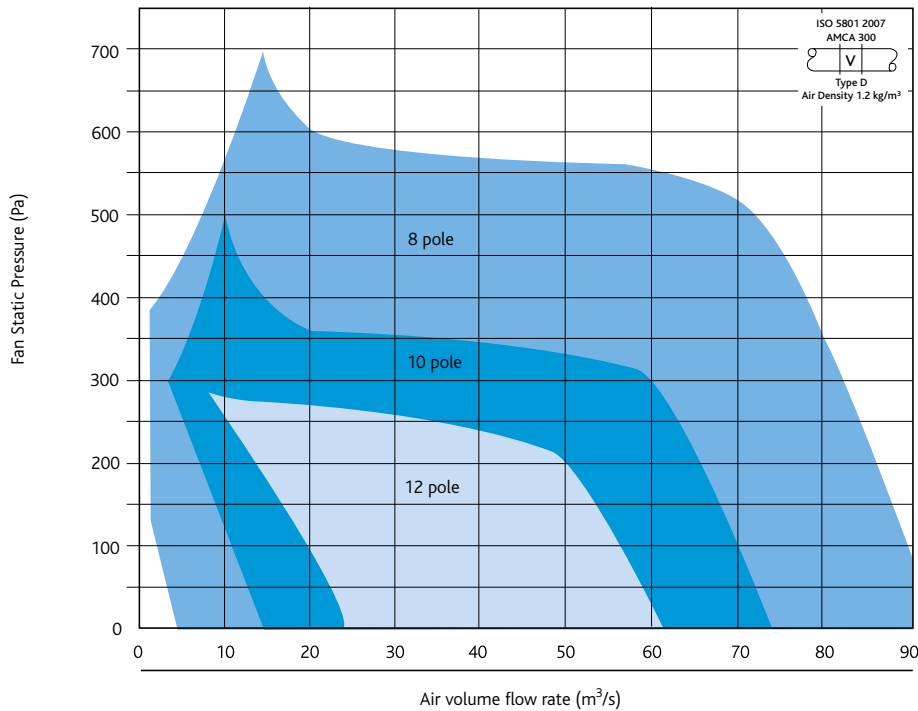
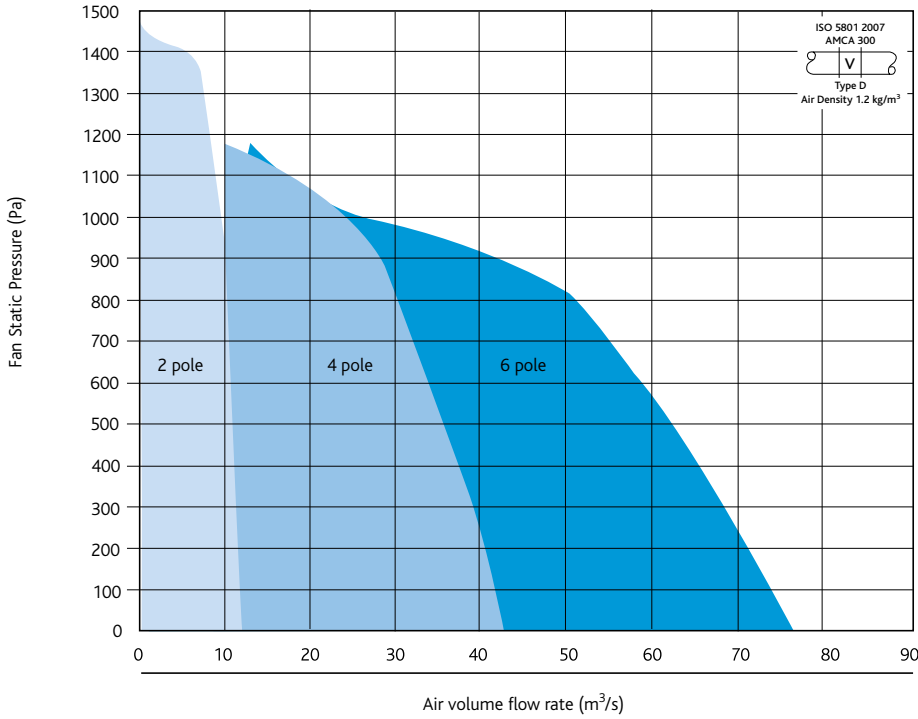

Casing

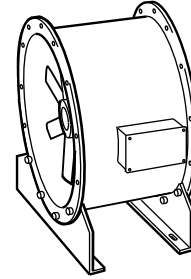

Code descriptions

AX100 Z - 4 1 3 A T

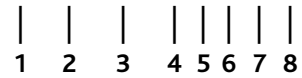

1. AXUS Long cased axial
2. Case diameter in cms
3. Impeller specification reference
4. Motor speed in poles
5. Impeller blade angle reference
6. Electrical supply in Phases
1 = 230V, 50Hz
3 = 400V, 50Hz
7. Impeller material
Without letter = standard GRP
A = Optional aluminium alloy
8. Other options (combinations possible)
T = Two speed (full and half)
F = Flameproof (EExd IIBT4)
2 = 90°C operation
Z = Access door

PERFORMANCE - AXUS LONG CASED AXIAL UNITS - 250MM Ø

250mm Ø 4 Pole/1440 rpm

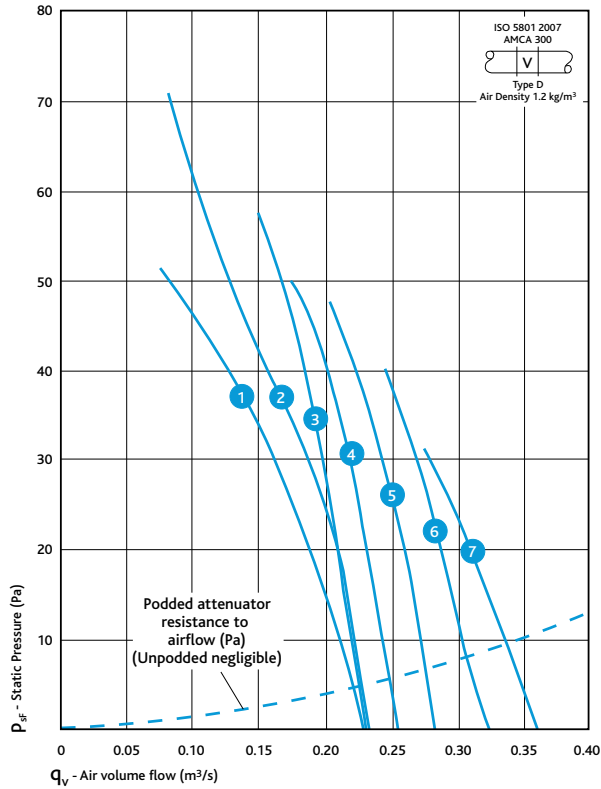

250mm Ø 2 Pole/2800 rpm

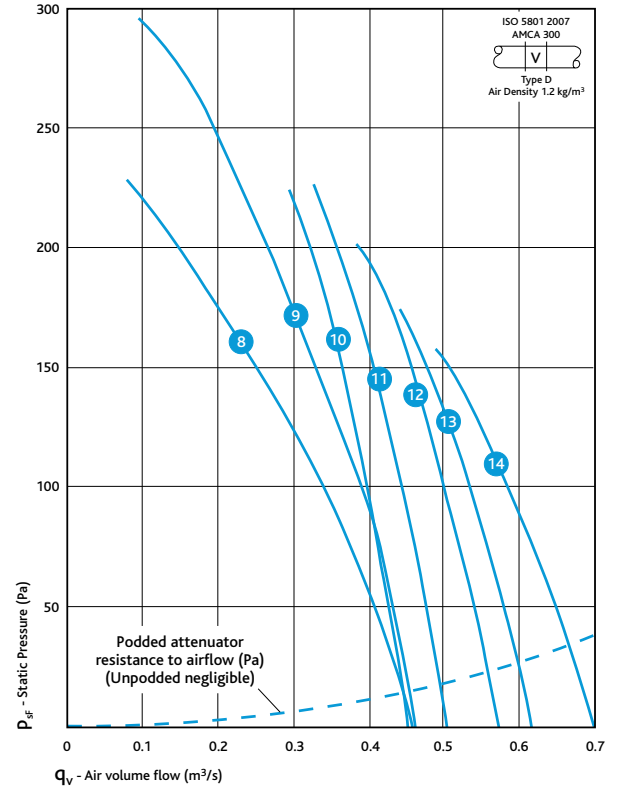

NOTE: THE CURVES ABOVE ARE INDICATIVE OF THE RANGE. A MORE COMPREHENSIVE SELECTION IS AVAILABLE, PLEASE CONTACT NUAIRE TECHNICAL, OR OBTAIN A COPY OF OUR FAN SELECTOR PROGRAMME VIA OUR WEBSITE.

ELECTRICAL & SOUND

Curve No	Unit Code	Blade Angle ^o	Speed RPM	Unit kg	A.V. Set	Motor frame size	1 Phase (230V-50Hz)			3 Phase (400V-50Hz)			In-duct inlet sound power levels dB re 1pW Octave band mid frequency Hz						Breakout dBA @ 3m	
							Motor kW	FLC amps	SC amps	Motor kW	FLC amps	SC amps	125	250	500	1K	2K	4K		8K
250 Ø - 4 Pole/1440rpm																				
1	AX25A-41*	25 ^o	1390	17	NAV1	63	0.12	1.2	3.4	0.12	0.42	1.2	74	65	56	51	47	39	29	35
2	AX25B-41*	25 ^o	1390	17	NAV1	63	0.12	1.2	3.4	0.12	0.42	1.2	74	70	60	55	50	44	35	36
3	AX25F-43*	35 ^o	1390	19	NAV1	63	0.12	1.2	3.4	0.12	0.42	1.2	71	69	62	59	53	46	39	35
4	AX25F-44*	40 ^o	1390	19	NAV1	63	0.12	1.2	3.4	0.12	0.42	1.2	76	70	62	60	54	46	40	37
5	AX25D-43*	35 ^o	1390	17	NAV1	63	0.12	1.2	3.4	0.12	0.42	1.2	75	68	60	55	51	45	37	35
6	AX25D-44*	40 ^o	1390	17	NAV1	63	0.12	1.2	3.4	0.12	0.42	1.2	71	67	59	55	51	45	39	34
7	AX25B-45*	45 ^o	1390	17	NAV1	63	0.12	1.2	3.4	0.12	0.42	1.2	83	69	61	55	52	47	40	39
250 Ø - 2 Pole/2800 rpm																				
8	AX25A-21*	25 ^o	2800	16	NAV1	63	0.18	1.4	6.3	0.18	0.5	1.9	99	87	79	71	65	58	50	55
9	AX25B-21*	25 ^o	2800	17	NAV1	63	0.18	1.4	6.3	0.18	0.5	1.9	74	81	72	69	65	61	52	53
10	AX25F-23*	35 ^o	2810	20	NAV1	71	0.25	2	6.8	0.25	0.68	2.7	85	82	77	72	69	64	57	53
11	AX25F-24*	40 ^o	2810	20	NAV1	71	0.25	2.3	6.8	0.25	0.68	2.7	90	81	78	75	71	64	58	53
12	AX25D-23*	35 ^o	2810	18	NAV1	71	0.25	2	6.8	0.25	0.68	2.7	79	76	76	70	68	63	56	47
13	AX25D-24*	40 ^o	2810	18	NAV1	71	0.25	2.3	6.8	0.25	0.68	2.7	82	81	76	72	69	63	57	55
14	AX25B-25*	45 ^o	2810	18	NAV1	71	0.25	2.4	6.8	0.25	0.68	2.7	76	79	76	73	68	61	56	49

Notes relating to the table: The electrical and sound information in the table is nominal. Breakout dBA@3m is spherical, free field. Start currents (sc) are DOL other than for motors of 4kW and above which are Star Delta (T).
 *Insert number for correct phase. 1 = 1 phase, 3 = 3 phase.
 For ancillaries please refer to page 310.

PERFORMANCE - AXUS LONG CASED AXIAL UNITS - 315MM Ø

315mm Ø 4 Pole/1440 rpm

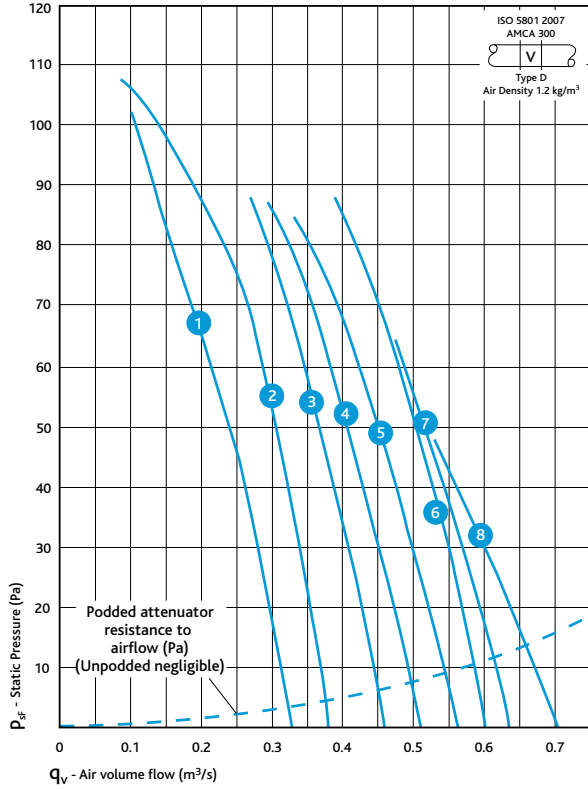

315mm Ø 2 Pole/2800 rpm

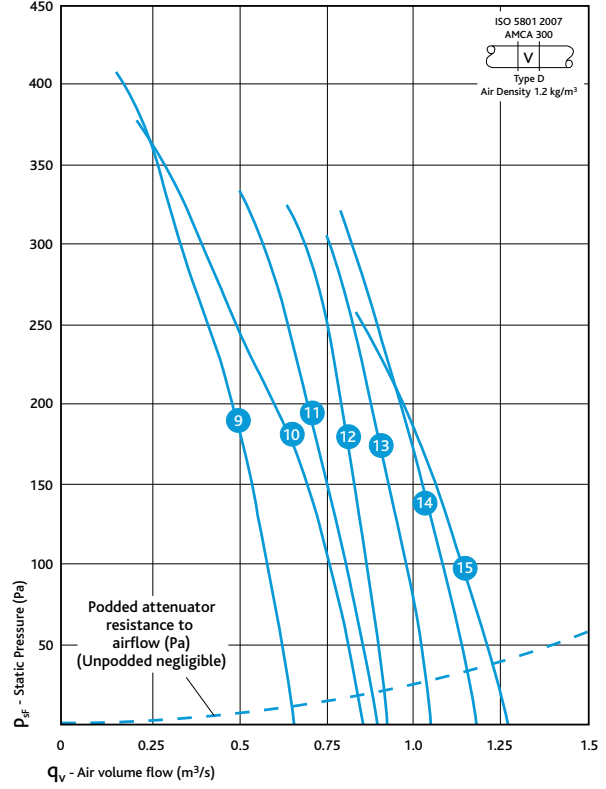

NOTE: THE CURVES ABOVE ARE INDICATIVE OF THE RANGE. A MORE COMPREHENSIVE SELECTION IS AVAILABLE, PLEASE CONTACT NUAIRE TECHNICAL, OR OBTAIN A COPY OF OUR FAN SELECTOR PROGRAMME VIA OUR WEBSITE.

ELECTRICAL & SOUND

Curve No	Unit Code	Blade Angle°	Speed RPM	Unit kg	A.V. Set	Motor frame size	1 Phase (230V-50Hz)			3 Phase (400V-50Hz)			In-duct inlet sound power levels dB re 1pW						Breakout dBA @ 3m	E	
							Motor kW	FLC amps	SC amps	Motor kW	FLC amps	SC amps	125	250	500	1K	2K	4K			8K
315 Ø - 4 Pole/1440rpm																					
1	AX31M-41*	20°	1390	20	NAV1	63	0.12	1.2	3.4	0.12	0.42	1.2	85	72	65	61	58	50	42	42	-
2	AX31X-41*	25°	1390	22	NAV1	63	0.12	1.2	3.4	0.12	0.42	1.2	77	72	63	61	58	48	42	40	-
3	AX31X-42*	30°	1390	22	NAV1	63	0.12	1.2	3.4	0.12	0.42	1.2	79	72	64	61	58	49	43	40	-
4	AX31X-44*	35°	1390	22	NAV1	63	0.12	1.2	3.4	0.12	0.42	1.2	77	70	63	62	58	48	41	39	-
5	AX31X-46*	40°	1390	22	NAV1	63	0.12	1.2	3.4	0.12	0.42	1.2	82	71	64	63	59	50	44	41	•
6	AX31F-44*	40°	1390	21	NAV1	63	0.12	1.2	3.4	0.12	0.42	1.2	70	75	63	65	61	53	46	41	•
7	AX31F-45*	45°	1390	21	NAV1	63	0.12	1.2	3.4	0.12	0.42	1.2	71	72	64	65	61	55	48	40	•
8	AX31B-45*	45°	1390	19	NAV1	63	0.12	1.2	3.4	0.12	0.42	1.2	71	71	63	61	59	55	50	39	•
315mm Ø - 2 Pole/2800 RPM																					
9	AX31M-21*	20°	2810	21	NAV1	71	0.25	2.3	6.8	0.25	0.68	2.3	81	97	80	78	74	70	63	57	-
10	AX31B-21*	25°	2810	20	NAV1	71	0.25	2.1	6.8	0.25	0.68	2.3	72	78	75	75	72	69	63	50	-
11	AX31X-22*	30°	2820	23	NAV2	71	0.37	3.1	13.5	0.37	1.0	3.5	85	86	80	77	73	68	64	54	-
12	AX31F-22*	30°	2810	23	NAV2	71	0.55	3.8	17.1	0.55	1.36	5.8	79	78	80	76	73	70	65	52	-
13	AX31F-23*	35°	2810	23	NAV2	71	0.55	4.1	17.1	0.55	1.36	5.8	79	77	78	77	74	71	65	52	-
14	AX31F-24*	40°	2810	23	NAV2	71	0.55	4.3	17.1	0.55	1.36	5.8	82	79	79	79	74	69	65	53	-
15	AX31B-24*	40°	2810	21	NAV1	71	0.55	4.1	17.1	0.55	1.36	5.8	76	80	78	78	73	68	64	50	-

Notes relating to the table: The electrical and sound information in the table is nominal. Breakout dBA@3m is spherical, free field. Start currents (sc) are DOL other than for motors of 4kW and above which are Star Delta (T). E = Electronic single phase speed controls. *Insert number for correct phase. 1 = 1 phase, 3 = 3 phase. For ancillaries please refer to page 310.

PERFORMANCE - AXUS LONG CASED AXIAL UNITS - 350MM Ø

350mm Ø 4 Pole/1440 rpm

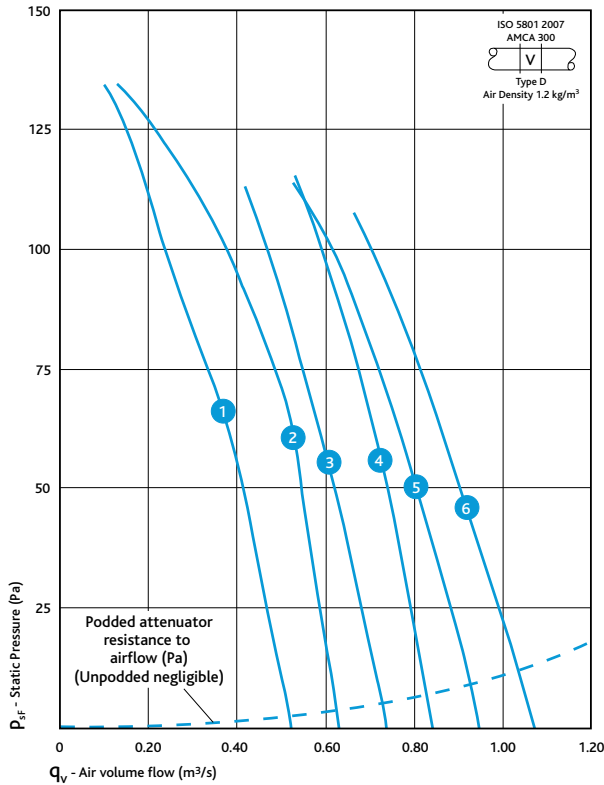

350mm Ø 2 Pole/2800 rpm

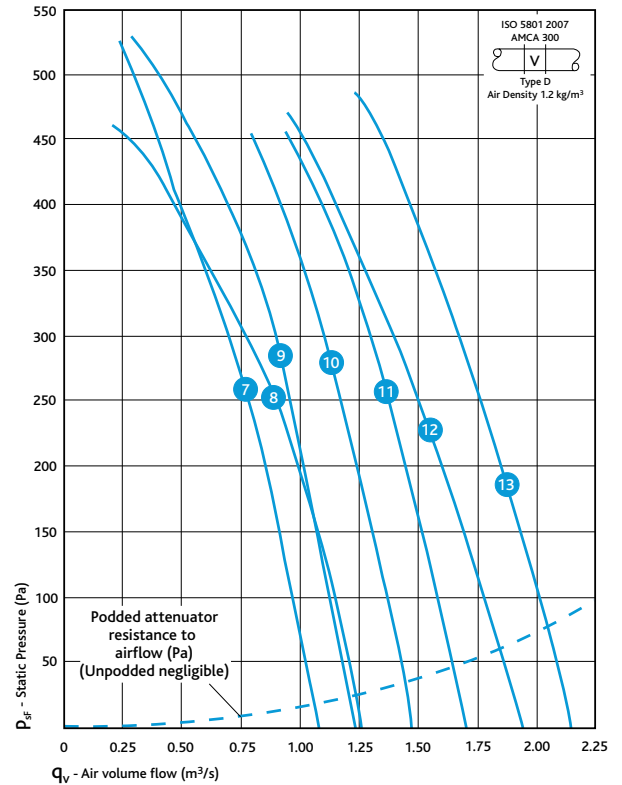

NOTE: THE CURVES ABOVE ARE INDICATIVE OF THE RANGE. A MORE COMPREHENSIVE SELECTION IS AVAILABLE, PLEASE CONTACT NUAIRE TECHNICAL, OR OBTAIN A COPY OF OUR FAN SELECTOR PROGRAMME VIA OUR WEBSITE.

ELECTRICAL & SOUND

Curve No	Unit Code	Blade Angle ^o	Speed RPM	Unit A.V. kg Set	Motor frame size	1 Phase (230V-50Hz)			3 Phase (400V-50Hz)			In-duct inlet sound power levels dB re 1pW Octave band mid frequency Hz								Breakout dBA @ 3m	E	
						Motor kW	FLC amps	SC amps	Motor kW	FLC amps	SC amps	125	250	500	1K	2K	4K	8K				
350mm Ø - 4 Pole/1440 RPM																						
1	AX35M-41*	20°	1390	21	NAV1	63	0.12	1.2	3.4	0.12	0.42	1.2	81	69	66	64	61	56	50	44	-	
2	AX35D-41*	25°	1390	21	NAV1	63	0.12	1.2	3.4	0.12	0.42	1.2	69	67	66	62	62	55	48	42	•	
3	AX35X-42*	30°	1390	22	NAV1	63	0.12	1.2	3.4	0.12	0.42	1.2	89	77	66	63	59	50	43	48	•	
4	AX35F-43*	35°	1390	22	NAV1	63	0.12	1.2	3.4	0.12	0.42	1.2	69	78	64	64	62	56	49	44	•	
5	AX35F-44*	40°	1390	22	NAV1	63	0.12	1.2	3.4	0.12	0.42	1.2	73	75	64	63	59	55	50	42	-	
6	AX35F-45*	45°	1400	22	NAV1	63	0.18	1.8	7.0	0.12	0.42	1.2	74	78	65	65	61	57	53	45	•	
350mm Ø - 2 Pole/2800 RPM																						
7	AX35M-21*	20°	2810	23	NAV2	71	0.55	3.8	17.1	0.55	1.36	5.8	81	88	79	81	76	72	67	55	-	
8	AX35B-21*	25°	2820	21	NAV1	71	0.37	3	13.5	0.37	1.0	3.5	73	84	76	77	74	72	66	53	-	
9	AX35X-21*	25°	2850	26	NAV2	80	0.75	5.3	21.2	0.75	1.6	9.4	84	89	81	80	76	74	66	57	-	
10	AX35X-22*	30°	2850	26	NAV2	80	0.75	5.6	21.2	0.75	1.9	9.4	85	96	81	81	77	74	66	60	-	
11	AX35X-24*	35°	2860	26	NAV2	80	1.1	6.8	26	1.1	2.5	15.4	87	88	83	84	79	75	68	58	-	
12	AX35M-27*	40°	2860	26	NAV2	80	1.1	7	26	1.1	2.6	15.4	86	101	82	82	79	74	69	65	-	
13	AX35F-25*	45°	2880	22	NAV1	90	1.5	9.9	44.7	1.5	3.8	24.5	90	85	86	84	81	76	71	60	-	

Notes relating to the table: The electrical and sound information in the table is nominal. Breakout dBA@3m is spherical, free field. Start currents (sc) are DOL other than for motors of 4kW and above which are Star Delta (T).

Note: All 3 phase fans are suitable for control by Ecosmart, Ecosmart BMS, Ecosmart control or standard inverter. E = Electronic single phase speed controls.

*Insert number for correct phase. 1 = 1 phase, 3 = 3 phase.

For ancillaries please refer to page 310.

PERFORMANCE - AXUS LONG CASED AXIAL UNITS - 400MM Ø

400mm Ø 4 Pole/1440 rpm

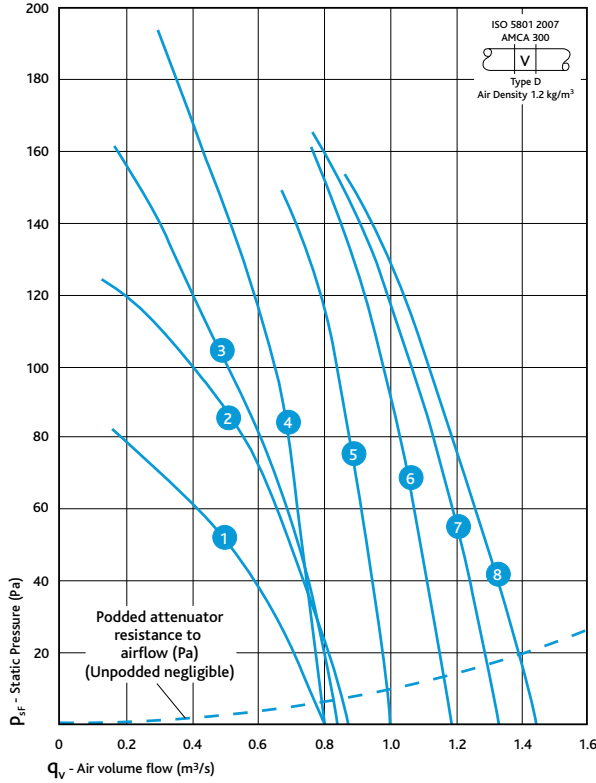

400mm Ø 2 Pole/2800 rpm

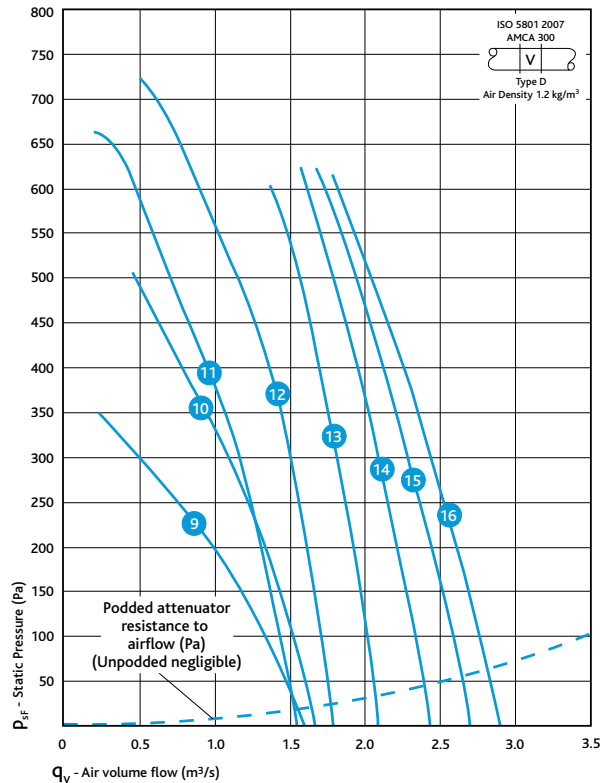

NOTE: THE CURVES ABOVE ARE INDICATIVE OF THE RANGE. A MORE COMPREHENSIVE SELECTION IS AVAILABLE, PLEASE CONTACT NUAIRE TECHNICAL, OR OBTAIN A COPY OF OUR FAN SELECTOR PROGRAMME VIA OUR WEBSITE.

ELECTRICAL & SOUND

Curve No	Unit Code	Blade Angle°	Speed RPM	Unit kg	A.V. Set	Motor frame size	1 Phase (230V-50Hz)			3 Phase (400V-50Hz)			In-duct inlet sound power levels dB re 1pW								Breakout dBA @ 3m	E
							Motor kW	FLC amps	SC amps	Motor kW	FLC amps	SC amps	Octave band mid frequency Hz									
													125	250	500	1K	2K	4K	8K			
400mm Ø - 4 Pole/1440 RPM																						
1	AX40A-411	25°	1390	25	NAV2	63	0.12	1.2	3.4	0.12	0.10	1.2	74	66	65	62	62	56	46	40	-	
2	AX40E-411	25°	1390	26	NAV2	63	0.12	1.2	3.4	0.12	0.10	1.2	75	69	66	64	64	58	49	41	-	
3	AX40D-411	25°	1390	26	NAV2	63	0.12	1.2	3.4	0.12	0.10	1.2	71	81	69	66	65	59	51	49	•	
4	AX40I-411	25°	1430	30	NAV2	71	0.25	2.2	9.5	0.25	0.77	2.3	72	77	73	69	67	63	54	45	•	
5	AX40I-421	30°	1430	30	NAV2	71	0.25	2.2	9.5	0.25	0.77	2.3	69	76	70	66	64	60	53	44	•	
6	AX40I-431	35°	1430	31	NAV2	71	0.37	2.9	11.6	0.37	1.06	3.5	72	79	70	67	63	58	53	45	•	
7	AX40I-441	40°	1430	31	NAV2	71	0.37	2.9	11.6	0.37	1.06	3.5	76	77	70	68	64	60	55	45	•	
8	AX40I-451	45°	1430	31	NAV2	71	0.37	2.9	11.6	0.37	1.06	3.5	76	77	71	69	64	60	55	46	•	
400mm Ø - 2 Pole/2800 RPM																						
9	AX40A-211	25°	2820	27	NAV2	71	0.37	3	13.5	0.37	1.0	3.5	82	87	81	79	74	69	67	54	-	
10	AX40B-211	25°	2810	28	NAV2	71	0.55	4.1	17.1	0.37	1.0	3.5	79	89	85	81	78	74	71	57	-	
11	AX40M-21*	20°	2850	31	NAV2	80	0.75	5.5	21.2	0.75	1.8	9.4	81	89	83	84	79	75	72	57	-	
12	AX40F-21*	25°	2880	38	NAV2	90	1.5	9.5	44.7	1.5	3.5	24.5	78	82	86	83	81	78	74	58	-	
13	AX40I-223	30°	2875	39	NAV2	90	-	-	-	1.8	3.7	28.9	82	81	89	84	80	78	75	61	-	
14	AX40I-233	35°	2875	39	NAV2	90	-	-	-	1.8	4.2	28.9	85	83	90	84	80	75	70	62	-	
15	AX40I-243	40°	2870	41	NAV2	90	-	-	-	2.2	5	31.5	88	86	92	85	81	76	72	63	-	
16	AX40I-253	45°	2870	44	NAV2	100	-	-	-	3	6.8	51	92	87	90	90	85	80	76	63	-	

Notes relating to the table: The electrical and sound information in the table is nominal. Breakout dBA@3m is spherical, free field.

Start currents (sc) are DOL other than for motors of 4kW and above which are Star Delta (T).

Note: All 3 phase fans are suitable for control by Ecosmart, Ecosmart BMS, Ecosmart control or standard inverter. E = Electronic single phase speed controls.

*Insert number for correct phase. 1 = 1 phase, 3 = 3 phase. For ancillaries please refer to page 310.

PERFORMANCE - AXUS LONG CASED AXIAL UNITS - 450MM Ø

450mm Ø 4 Pole/1440 rpm

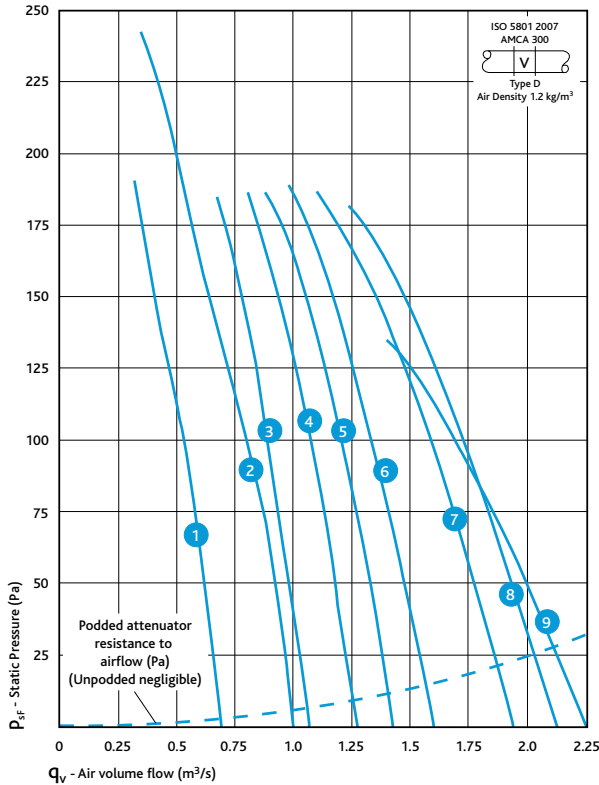

450mm Ø 2 Pole/2800 rpm

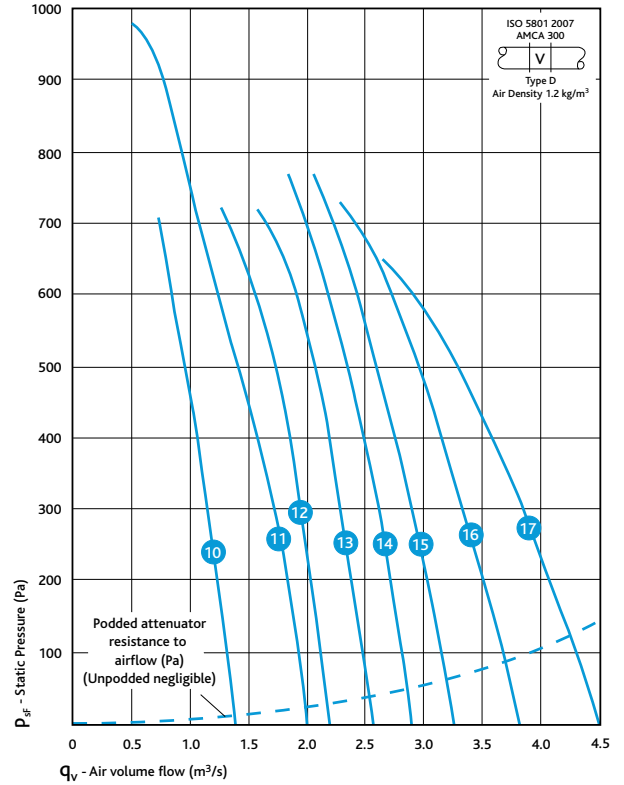

NOTE: THE CURVES ABOVE ARE INDICATIVE OF THE RANGE. A MORE COMPREHENSIVE SELECTION IS AVAILABLE, PLEASE CONTACT NUAIRE TECHNICAL, OR OBTAIN A COPY OF OUR FAN SELECTOR PROGRAMME VIA OUR WEBSITE.

ELECTRICAL & SOUND

Curve No	Unit Code	Blade Angle ^o	Speed RPM	Unit kg	A.V. Set	Motor frame size	1 Phase (230V-50Hz)			3 Phase (400V-50Hz)			In-duct inlet sound power levels dB re 1pW Octave band mid frequency Hz						Breakout dBA @ 3m	E	
							Motor kW	FLC amps	SC amps	Motor kW	FLC amps	SC amps	125	250	500	1K	2K	4K			8K
450mm Ø - 4 Pole/1440 RPM																					
1	AX45S-41*	20 ^o	1410	34	NAV2	71	0.25	2.2	9.5	0.25	0.77	2.3	82	81	80	75	71	66	58	52	•
2	AX45P-41*	20 ^o	1410	32	NAV2	71	0.25	2.2	9.5	0.25	0.77	2.3	79	79	78	74	71	66	58	50	•
3	AX45S-43*	30 ^o	1430	36	NAV2	71	0.37	2.9	11.6	0.37	1.06	3.5	83	82	78	75	70	64	57	51	•
4	AX45S-45*	35 ^o	1410	37	NAV2	80	0.55	4.3	15.5	0.55	1.44	5.6	83	81	80	78	72	68	61	53	•
5	AX45S-47*	40 ^o	1410	37	NAV2	80	0.55	4.3	15.5	0.55	1.44	5.6	85	86	80	78	71	65	59	54	•
6	AX45S-48*	45 ^o	1410	37	NAV2	80	0.55	4.6	15.5	0.55	1.44	5.6	83	84	80	77	69	65	59	55	•
7	AX45P-47*	40 ^o	1410	35	NAV2	80	0.55	4.4	15.5	0.55	1.44	5.6	81	80	74	71	66	60	56	49	•
8	AX45P-48*	45 ^o	1410	35	NAV2	80	0.55	4.6	15.5	0.55	1.44	5.6	80	81	73	71	66	60	55	49	•
9	AX45D-45*	45 ^o	1430	31	NAV2	71	0.37	3.1	11.6	0.55	1.44	5.6	75	79	74	70	66	61	58	55	•
450mm Ø - 2 Pole/2800 RPM																					
10	AX45S-213	20 ^o	2875	45	NAV2	90	-	-	-	1.8	3.9	28.9	89	89	93	94	90	85	81	66	-
11	AX45P-213	20 ^o	2875	42	NAV2	90	-	-	-	1.8	3.9	28.9	85	86	91	91	87	83	81	64	-
12	AX45S-233	30 ^o	2870	50	NAV2	100	-	-	-	3	6.7	51	91	90	93	94	91	86	83	66	-
13	AX45S-253	35 ^o	2855	55	NAV2	112	-	-	-	4	8.6	T22.4	91	91	95	94	90	86	82	68	-
14	AX45S-273	40 ^o	2855	55	NAV2	112	-	-	-	4	9.5	T22.4	93	95	97	93	88	83	79	69	-
15	AX45S-283	45 ^o	2910	65	NAV2	132	-	-	-	5.5	12.1	T33	93	93	96	93	88	83	79	69	-
16	AX45AA-263	40 ^o	2855	56	NAV2	112	-	-	-	4	9.6	T22.4	92	89	92	90	85	80	74	66	-
17	AX45F-253	45 ^o	2855	51	NAV2	112	-	-	-	4	8.4	T22.4	87	84	92	90	86	82	79	66	-

Notes relating to the table: The electrical and sound information in the table is nominal. Breakout dBA@3m is spherical, free field. Start currents (sc) are DOL other than for motors of 4kW and above which are Star Delta (T).

Note: All 3 phase fans are suitable for control by Ecosmart, Ecosmart BMS, Ecosmart control or standard inverter. E = Electronic single phase speed controls.

*Insert number for correct phase. 1 = 1 phase, 3 = 3 phase. For ancillaries please refer to page 310.

PERFORMANCE - AXUS LONG CASED AXIAL UNITS - 500MM Ø

500mm Ø 4 Pole/1440 rpm

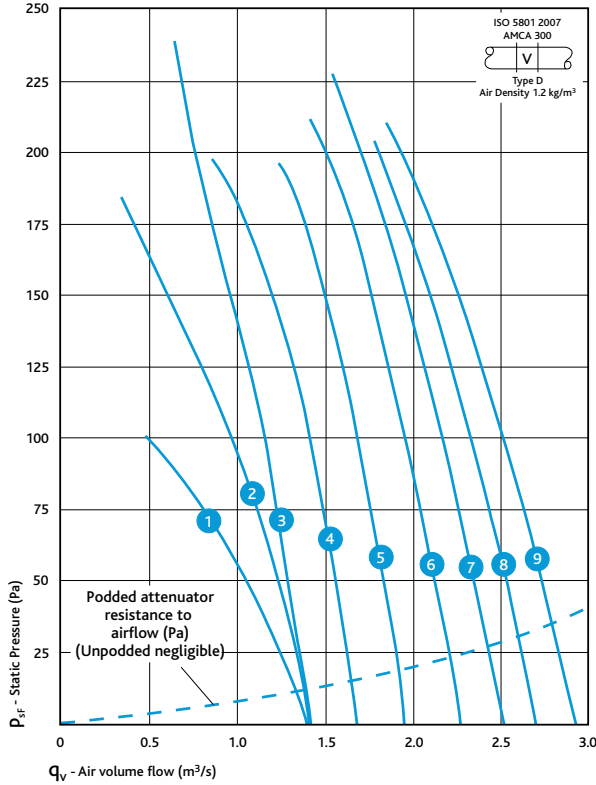

500mm Ø 2 Pole/2800 rpm

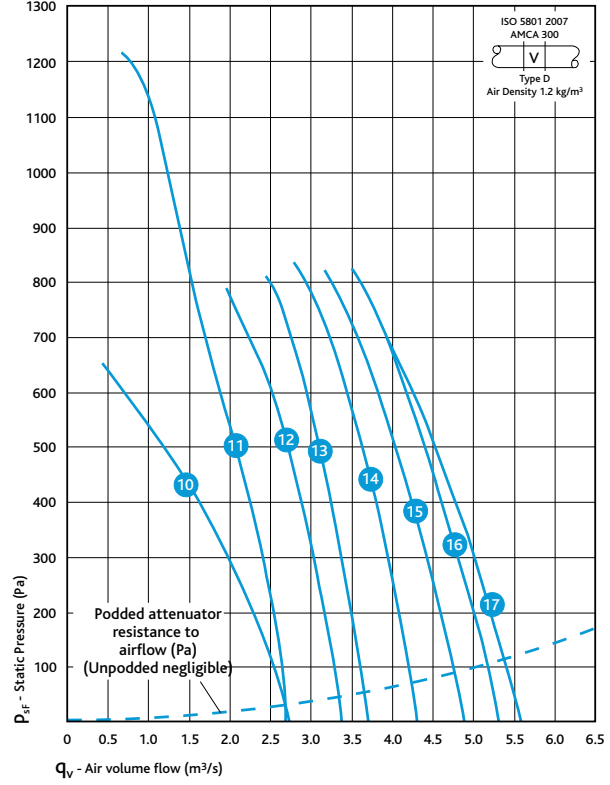

NOTE: THE CURVES ABOVE ARE INDICATIVE OF THE RANGE. A MORE COMPREHENSIVE SELECTION IS AVAILABLE, PLEASE CONTACT NUAIRE TECHNICAL, OR OBTAIN A COPY OF OUR FAN SELECTOR PROGRAMME VIA OUR WEBSITE.

ELECTRICAL & SOUND

Curve No	Unit Code	Blade Angle°	Speed RPM	Unit kg	A.V. Set	Motor frame size	1 Phase (230V-50Hz)			3 Phase (400V-50Hz)			In-duct inlet sound power levels dB re 1pW							Breakout dBA @ 3m	E			
							Motor kW	FLC amps	SC amps	Motor kW	FLC amps	SC amps	Octave band mid frequency Hz											
													125	250	500	1K	2K	4K	8K					
500mm Ø - 4 Pole/1440 RPM																								
1	AX50C-41*	25°	1390	29	NAV2	63	0.12	1.2	3.4	0.12	0.42	1.2	73	73	72	71	68	65	53	45	•			
2	AX50D-41*	25°	1400	29	NAV2	63	0.18	1.8	7.0	0.18	0.56	1.7	70	77	72	71	71	68	55	48	•			
3	AX50P-41*	20°	1430	35	NAV2	71	0.37	2.9	11.6	0.37	1.0	3.5	79	80	81	77	73	68	60	53	•			
4	AX50P-42*	25°	1430	35	NAV2	71	0.37	2.9	11.6	0.37	1.0	3.5	78	79	79	77	74	69	61	52	•			
5	AX50S-45*	35°	1410	40	NAV2	80	0.75	5.7	21.5	0.75	2.1	9	81	84	80	78	73	68	61	53	•			
6	AX50S-47*	40°	1430	44	NAV2	90	1.1	8.9	29.8	1.1	2.6	12.5	85	84	78	77	70	65	60	53	-			
7	AX50S-48*	45°	1430	44	NAV2	90	1.1	8.9	29.8	1.1	2.6	12.5	85	84	78	78	70	64	60	53	-			
8	AX50P-47*	40°	1430	42	NAV2	90	1.1	8.9	29.8	1.1	2.5	12.5	79	80	77	74	70	64	60	52	-			
9	AX50P-48*	45°	1430	42	NAV2	90	1.1	8.9	29.8	1.1	2.6	12.5	79	80	77	74	69	63	59	52	-			
500mm Ø - 2 Pole/2800 RPM																								
10	AX50B-21*	25°	2860	34	NAV2	80	1.1	6.5	26	1.1	2.3	15.4	80	89	90	89	89	85	84	64	-			
11	AX50P-213	20°	2870	48	NAV2	100	-	-	-	3	6.7	51	87	87	93	95	92	87	85	67	-			
12	AX50P-223	25°	2855	53	NAV2	112	-	-	-	4	8.4	T22.4	86	90	96	95	92	86	81	68	-			
13	AX50S-243	32.5°	2910	67	NAV2	132	-	-	-	5.5	12.4	T33	93	94	96	94	89	85	81	69	-			
14	AX50S-263	37.5°	2925	78	NAV2	132	-	-	-	7.5	15.7	T42	94	92	98	96	91	87	85	70	-			
15	AX50S-283	45°	2890	88	NAV5	132	-	-	-	9	19.4	T50	97	96	99	96	92	87	85	72	-			
16	AX50P-273	40°	2925	75	NAV2	132	-	-	-	7.5	15.7	T42	94	92	98	94	90	85	85	70	-			
17	AX50P-283	45°	2890	85	NAV5	132	-	-	-	9	18	T50	93	91	99	95	91	86	85	71	-			

Notes relating to the table: The electrical and sound information in the table is nominal. Breakout dBA@3m is spherical, free field.

Start currents (sc) are DOL other than for motors of 4kW and above which are Star Delta (T).

Note: All 3 phase fans are suitable for control by Ecosmart, Ecosmart BMS, Ecosmart control or standard inverter. E = Electronic single phase speed controls.

*Insert number for correct phase. 1 = 1 phase, 3 = 3 phase. For ancillaries please refer to page 310.

PERFORMANCE - AXUS LONG CASED AXIAL UNITS - 560MM Ø

560mm Ø 4 Pole/1440 rpm

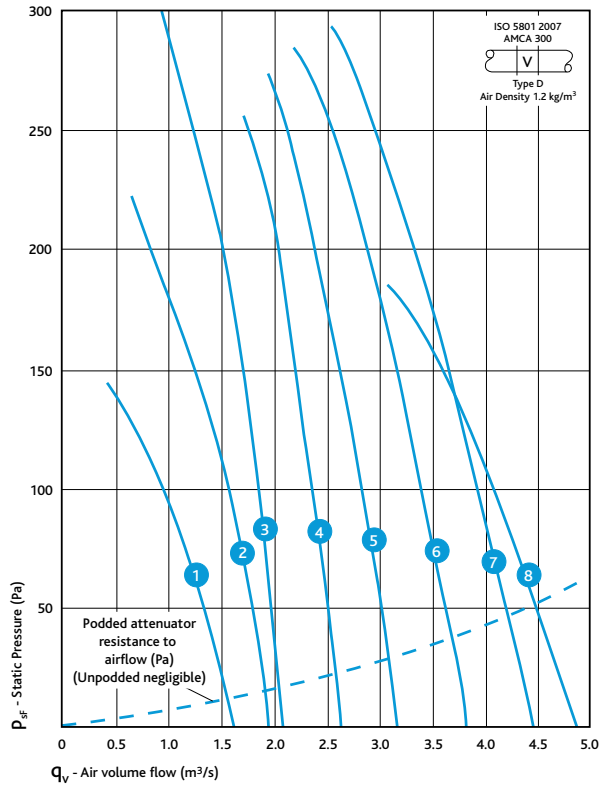

560mm Ø 2 Pole/2800 rpm

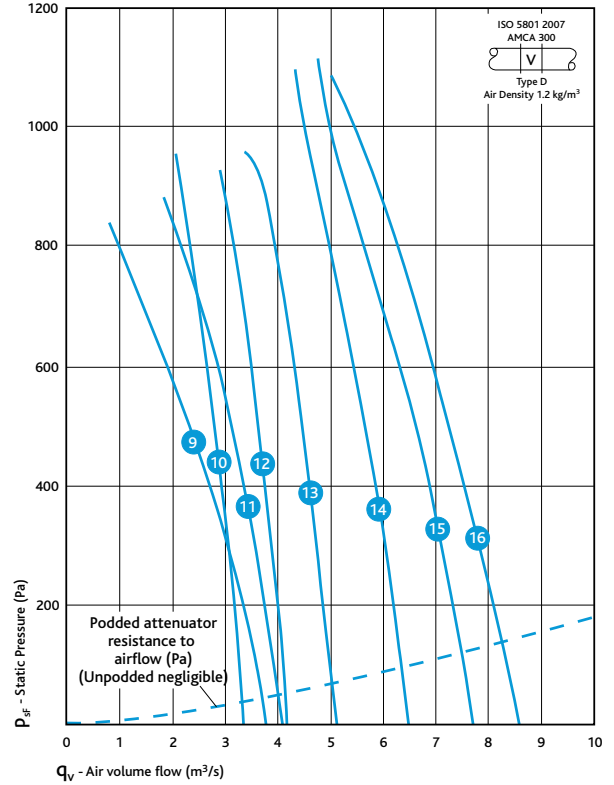

NOTE: THE CURVES ABOVE ARE INDICATIVE OF THE RANGE. A MORE COMPREHENSIVE SELECTION IS AVAILABLE, PLEASE CONTACT NUAIRE TECHNICAL, OR OBTAIN A COPY OF OUR FAN SELECTOR PROGRAMME VIA OUR WEBSITE.

ELECTRICAL & SOUND

Curve No	Unit Code	Blade Angle ^o	Speed RPM	Unit kg	A.V. Set	Motor frame size	1 Phase (230V-50Hz)			3 Phase (400V-50Hz)			In-duct inlet sound power levels dB re 1pW						Breakout dBA @ 3m	E	
							Motor kW	FLC amps	SC amps	Motor kW	FLC amps	SC amps	Octave band mid frequency Hz								
													125	250	500	1K	2K	4K	8K		
560mm Ø - 4 Pole/1440 RPM																					
1	AX56B-41*	25 ^o	1430	32	NAV2	71	0.25	2.2	9.5	0.25	0.77	2.3	76	76	74	75	72	63	53	48	•
2	AX56F-41*	25 ^o	1430	35	NAV2	71	0.37	2.9	11.6	0.37	1.06	3.5	75	76	75	75	74	74	61	50	•
3	AX56S-42*	25 ^o	1410	43	NAV2	80	0.75	5.7	21.5	0.75	2.1	9	75	73	81	80	78	75	74	55	•
4	AX56S-43*	30 ^o	1430	46	NAV2	90	1.1	8.9	29.8	1.1	2.6	12.5	78	76	82	81	78	75	73	56	-
5	AX56S-453	35 ^o	1435	47	NAV2	90	-	-	-	1.5	3.6	21.2	80	79	83	80	76	72	68	56	-
6	AX56S-483	45 ^o	1440	49	NAV2	90	-	-	-	1.8	4.5	23.4	83	87	83	81	77	74	68	55	-
7	AX56AA-473	45 ^o	1440	49	NAV2	90	-	-	-	1.8	4.3	23.4	83	82	82	79	74	70	66	53	-
8	AX56X-483	50 ^o	1435	44	NAV2	90	-	-	-	1.5	3.6	21.2	87	79	80	77	71	66	63	52	-
560mm Ø - 2 Pole/2800 RPM																					
9	AX56D-213	25 ^o	2875	42	NAV2	90	-	-	-	1.8	3.7	28.9	83	79	88	91	89	87	86	66	-
10	AX56S-213	20 ^o	2910	80	NAV2	132	-	-	-	5.5	12.1	T33	92	84	97	96	93	90	88	69	-
11	AX56F-213	25 ^o	2870	49	NAV2	100	-	-	-	3	6.7	51	86	82	89	89	90	88	87	65	-
12	AX56S-223	25 ^o	2910	80	NAV2	132	-	-	-	5.5	12.1	T33	90	89	97	96	94	91	89	70	-
13	AX56S-233	30 ^o	2890	102	NAV5	132	-	-	-	9	18	T48	97	93	99	97	92	89	84	70	-
14	AX56S-253	35 ^o	2940	116	NAV5	132	-	-	-	11	23.2	T52	95	94	98	95	91	88	83	71	-
15	AX56P-273	40 ^o	2940	113	NAV5	132	-	-	-	11	23	T52	93	92	100	95	91	87	83	69	-
16	AX56AA-263	40 ^o	2940	118	NAV5	132	-	-	-	15	28.3	T80	99	98	98	94	90	86	81	69	-

Notes relating to the table: The electrical and sound information in the table is nominal. Breakout dBA@3m is spherical, free field.

Start currents (sc) are DOL other than for motors of 4kW and above which are Star Delta (T).

Note: All 3 phase fans are suitable for control by Ecosmart, Ecosmart BMS, Ecosmart control or standard inverter. E = Electronic single phase speed controls.

*Insert number for correct phase. 1 = 1 phase, 3 = 3 phase. For ancillaries please refer to page 310.

PERFORMANCE - AXUS LONG CASED AXIAL UNITS - 630MM Ø

630mm Ø 4 Pole/1440 rpm

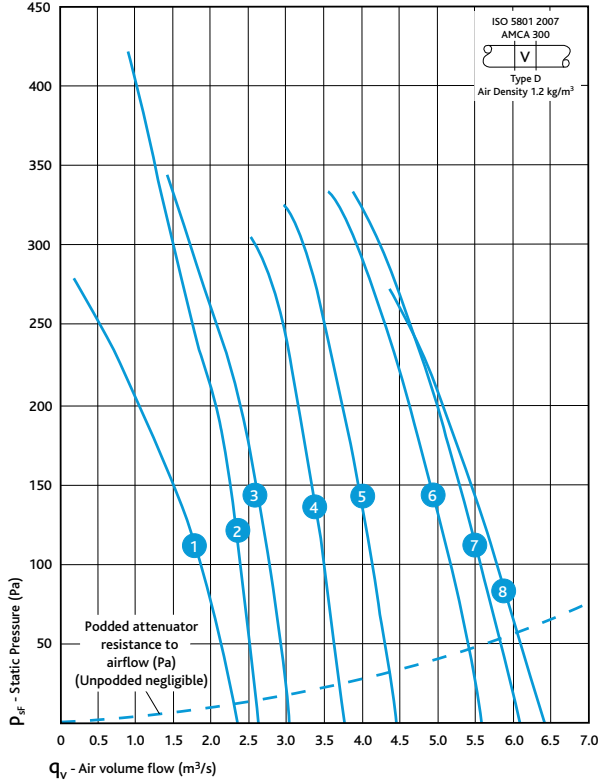

630mm Ø 2 Pole/2800 rpm

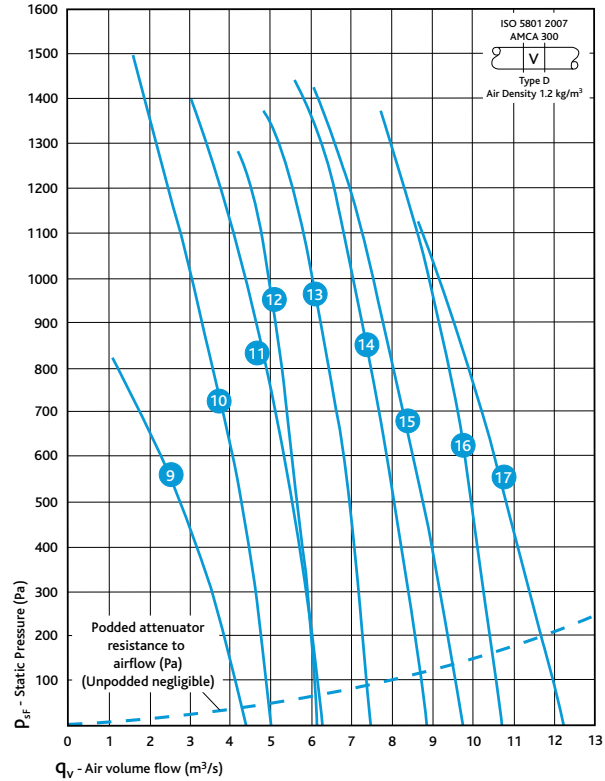

NOTE: THE CURVES ABOVE ARE INDICATIVE OF THE RANGE. A MORE COMPREHENSIVE SELECTION IS AVAILABLE, PLEASE CONTACT NUAIRE TECHNICAL, OR OBTAIN A COPY OF OUR FAN SELECTOR PROGRAMME VIA OUR WEBSITE.

ELECTRICAL & SOUND

Curve No	Unit Code	Blade Angle°	Speed RPM	Unit kg	A.V. Set	Motor frame size	1 Phase (230V-50Hz)			3 Phase (400V-50Hz)			In-duct inlet sound power levels dB re 1pW Octave band mid frequency Hz								Breakout dBA @ 3m	E
							Motor kW	FLC amps	SC amps	Motor kW	FLC amps	SC amps	125	250	500	1K	2K	4K	8K			
630mm Ø - 4 Pole/1440 RPM																						
1	AX63F-41*	25°	1430	39	NAV2	71	0.37	3.2	11.6	0.37	1.06	3.5	72	79	78	80	80	77	65	54	•	
2	AX63S-41*	20°	1430	43	NAV2	90	1.1	8.9	29.8	1.1	2.6	12.5	85	85	83	81	78	76	68	56	-	
3	AX63S-42*	25°	1430	50	NAV2	90	1.1	9.1	29.8	1.1	2.7	12.5	82	82	83	80	77	75	67	55	-	
4	AX63AD-423	30°	1440	56	NAV2	90	-	-	-	1.8	4.7	23.4	85	87	86	80	76	72	64	57	-	
5	AX63AD-443	35°	1440	59	NAV2	100	-	-	-	2.2	5.7	27.6	85	90	85	81	78	76	68	58	-	
6	AX63AD-473	45°	1430	61	NAV2	100	-	-	-	3	7.8	37.2	87	87	84	81	77	73	67	58	-	
7	AX63AD-483	50°	1435	65	NAV2	112	-	-	-	4	10.1	T17.7	86	87	86	82	78	74	68	59	-	
8	AX63AA-483	50°	1435	63	NAV2	112	-	-	-	4	9.3	T17.7	83	87	85	82	77	71	67	58	-	
630mm Ø - 2 Pole/2800 RPM																						
9	AX63D-213	25°	2870	48	NAV2	90	-	-	-	2.2	4.5	31.5	80	79	94	95	96	92	87	71	-	
10	AX63P-213	20°	2910	81	NAV2	132	-	-	-	5.5	12.1	T33	86	89	97	99	98	92	90	72	-	
11	AX63S-223	25°	2890	104	NAV5	132	-	-	-	9	19.2	T48	89	90	99	97	95	92	89	72	-	
12	AX63AD-213	25°	2940	123	NAV5	132	-	-	-	11	23.1	T52	92	92	100	99	96	92	93	73	-	
13	AX63AD-223	30°	2940	121	NAV5	160	-	-	-	15	29.8	T80	95	94	105	98	95	91	91	75	-	
14	AX63AD-243	35°	2950	156	NAV3	160	-	-	-	18.5	34.3	T92	97	97	107	100	95	92	91	77	-	
15	AX63AD-263	40°	2950	165	NAV3	180	-	-	-	22	40.2	T110	99	98	107	100	96	93	88	78	-	
16	AX63AD-273	45°	2955	211	NAV4	180	-	-	-	30	50.2	T147	102	103	110	105	101	97	92	81	-	
17	AX63AA-263	50°	2955	209	NAV4	180	-	-	-	30	50.2	T147	97	98	106	102	97	93	89	79	-	

Notes relating to the table: The electrical and sound information in the table is nominal. Breakout dBA@3m is spherical, free field.

Start currents (sc) are DOL other than for motors of 4kW and above which are Star Delta (T).

Note: All 3 phase fans are suitable for control by Ecosmart, Ecosmart BMS, Ecosmart control or standard inverter. E = Electronic single phase speed controls.

Note: AX63S-42* is not speed controllable. *Insert number for correct phase. 1 = 1 phase, 3 = 3 phase. For ancillaries please refer to page 310.

PERFORMANCE - AXUS LONG CASED AXIAL UNITS - 710MM Ø

710mm Ø 6 Pole/960 rpm

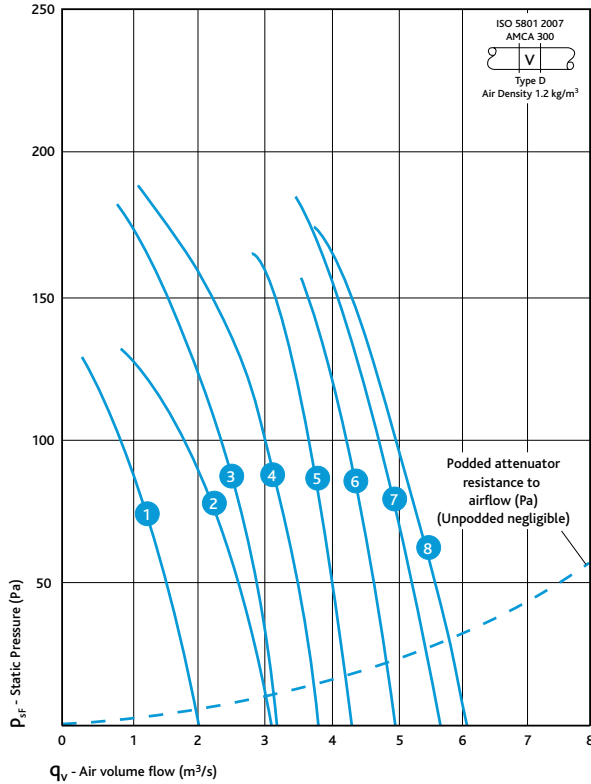

710mm Ø 4 Pole/1440 rpm

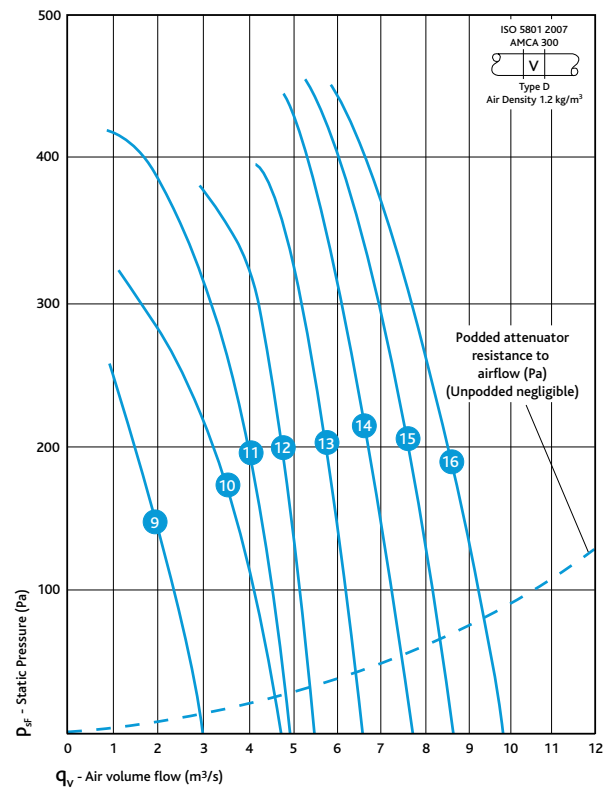

NOTE: THE CURVES ABOVE ARE INDICATIVE OF THE RANGE. A MORE COMPREHENSIVE SELECTION IS AVAILABLE, PLEASE CONTACT NUAIRE TECHNICAL, OR OBTAIN A COPY OF OUR FAN SELECTOR PROGRAMME VIA OUR WEBSITE.

ELECTRICAL & SOUND

Curve No	Unit Code	Blade Angle ^o	Speed RPM	Unit kg	A.V. Set	Motor frame size	1 Phase (230V-50Hz)			3 Phase (400V-50Hz)			In-duct inlet sound power levels dB re 1pW Octave band mid frequency Hz						Breakout dBA @ 3m	E	
							Motor kW	FLC amps	SC amps	Motor kW	FLC amps	SC amps	125	250	500	1K	2K	4K			8K
710mm Ø - 6 Pole/960 RPM																					
1	AX710-61*	20 ^o	955	43	NAV2	80	0.37	3	10.5	0.55	1.8	7.6	78	79	76	76	72	66	57	49	•
2	AX710-62*	25 ^o	955	43	NAV2	80	0.37	3	10.5	0.55	1.8	7.6	77	79	72	72	70	66	57	47	•
3	AX71P-62*	25 ^o	955	43	NAV2	80	0.37	3.4	10.5	0.55	1.8	7.6	82	76	74	74	72	67	58	49	•
4	AX71AA-62*	30 ^o	960	47	NAV2	80	0.55	3.6	10	0.55	1.8	7.6	83	78	74	74	73	65	56	49	•
5	AX71AD-643	35 ^o	920	57	NAV2	90	-	-	-	1.1	3.2	13.6	79	79	77	73	70	64	58	50	-
6	AX71AD-663	40 ^o	910	61	NAV2	100	-	-	-	1.5	4.8	18.5	81	79	77	73	70	65	60	50	-
7	AX71AD-673	45 ^o	910	61	NAV2	100	-	-	-	1.5	5	18.5	79	78	78	73	70	65	61	51	-
8	AX71AD-683	50 ^o	930	61	NAV2	100	-	-	-	1.8	5.1	20.3	79	81	79	75	72	67	61	52	-
710mm Ø - 4 Pole/1440 RPM																					
9	AX710-41*	20 ^o	1410	44	NAV2	80	0.75	5.7	21.5	0.75	2	9	83	82	84	85	81	78	72	57	-
10	AX710-42*	25 ^o	1430	48	NAV2	90	1.1	8.9	29.8	1.1	2.6	12.5	81	81	80	80	79	77	70	56	-
11	AX71P-423	25 ^o	1440	48	NAV2	90	-	-	-	1.8	4.1	23.4	100	95	90	86	81	79	72	61	-
12	AX71AD-423	30 ^o	1430	63	NAV2	100	-	-	-	3	7.3	37.2	83	92	88	86	83	81	72	60	-
13	AX71AA-463	40 ^o	1435	64	NAV2	112	-	-	-	4	9.3	T17.7	83	95	89	86	83	81	73	63	-
14	AX71AD-463	40 ^o	1445	97	NAV5	132	-	-	-	5.5	11.4	T25.8	86	91	86	83	80	75	69	60	-
15	AX71AD-473	45 ^o	1445	97	NAV5	132	-	-	-	5.5	12.4	T25.8	85	96	87	85	80	75	70	62	-
16	AX71AD-483	50 ^o	1450	124	NAV5	132	-	-	-	7.5	15.7	T38.2	86	94	90	87	84	80	76	64	-

Notes relating to the table: The electrical and sound information in the table is **nominal**. Breakout dBA@3m is spherical, free field.

Start currents (sc) are DOL other than for motors of 4kW and above which are Star Delta (T).

Note: All 3 phase fans are suitable for control by Ecosmart, Ecosmart BMS, Ecosmart control or standard inverter. E = Electronic single phase speed controls.

*Insert number for correct phase. 1 = 1 phase, 3 = 3 phase. For ancillaries please refer to page 310.

PERFORMANCE - AXUS LONG CASED AXIAL UNITS - 800MM Ø

800mm Ø 6 Pole/960 rpm

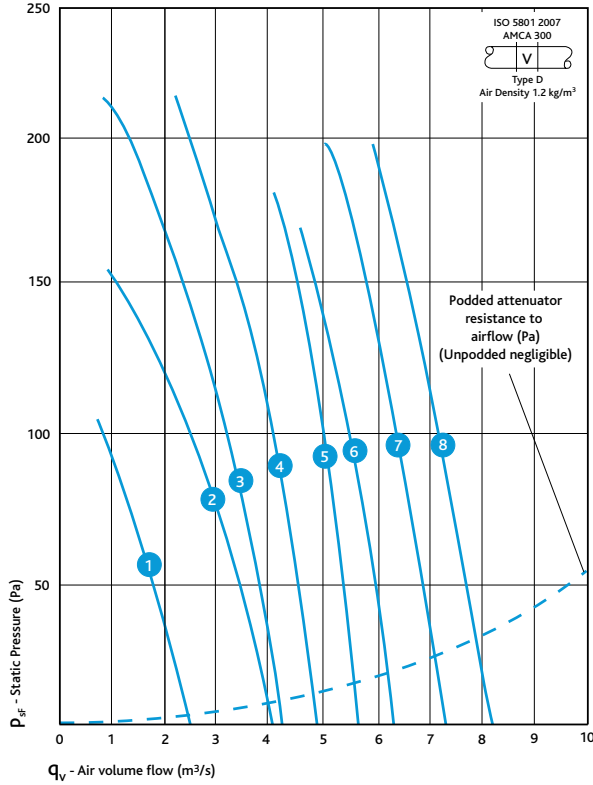

800mm Ø 4 Pole/1400 rpm

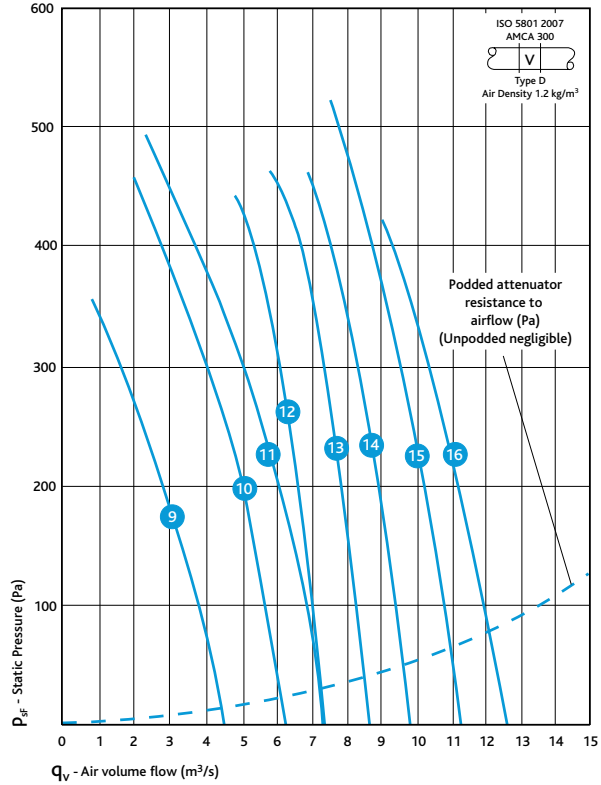

NOTE: THE CURVES ABOVE ARE INDICATIVE OF THE RANGE. A MORE COMPREHENSIVE SELECTION IS AVAILABLE, PLEASE CONTACT NUAIRE TECHNICAL, OR OBTAIN A COPY OF OUR FAN SELECTOR PROGRAMME VIA OUR WEBSITE.

ELECTRICAL & SOUND

Curve No	Unit Code	Blade Angle°	Speed RPM	Unit kg	A.V. Set	Motor frame size	1 Phase (230V-50Hz)			3 Phase (400V-50Hz)			In-duct inlet sound power levels dB re 1pW								Breakout dBA @ 3m	E
							Motor kW	FLC amps	SC amps	Motor kW	FLC amps	SC amps	Octave band mid frequency Hz	125	250	500	1K	2K	4K	8K		
800mm Ø - 6 Pole/960 RPM																						
1	AX800-611	20°	955	52	NAV2	80	0.37	3	10.5	0.55	1.8	7.6	80	80	81	80	74	69	59	53	•	
2	AX800-621	25°	960	53	NAV2	80	0.55	2.2	9.8	0.55	1.8	7.6	80	76	76	77	75	71	60	50	•	
3	AX80P-621	25°	960	53	NAV2	80	0.55	2.2	9.8	0.55	1.8	7.6	82	75	77	76	75	71	60	50	•	
4	AX80AG-623	30°	910	87	NAV5	100	-	-	-	1.5	4.7	18.5	82	85	83	79	78	72	63	56	-	
5	AX80AG-643	35°	915	87	NAV5	112	-	-	-	2.2	6.4	28.2	80	86	81	79	78	74	66	55	-	
6	AX80AG-663	40°	915	87	NAV5	112	-	-	-	2.2	6.6	28.2	81	84	81	78	76	72	64	55	-	
7	AX80AG-673	45°	950	125	NAV5	132	-	-	-	3	7.9	41.2	84	86	83	79	76	71	66	58	-	
8	AX80AG-683	50°	970	135	NAV3	132	-	-	-	4	10	T21	3	88	84	81	78	74	68	57	-	
800mm Ø - 4 Pole/1440 RPM																						
9	AX800-41*	20°	1430	57	NAV2	90	1.1	8.9	29.8	1.1	2.5	12.5	83	84	86	91	88	82	76	62	-	
10	AX80P-423	25°	1440	63	NAV2	100	-	-	-	2.2	5.2	27.6	80	86	87	87	85	84	78	61	-	
11	AX80AA-423	30°	1430	69	NAV2	100	-	-	-	3	7.3	37.2	82	88	88	86	83	82	74	61	-	
12	AX80AG-423	30°	1445	118	NAV5	132	-	-	-	5.5	12.4	T25.8	86	91	93	89	86	85	78	64	-	
13	AX80AG-443	35°	1450	134	NAV3	132	-	-	-	7.5	16.2	T38.2	87	89	92	90	87	85	79	64	-	
14	AX80AG-463	40°	1455	141	NAV3	132	-	-	-	9	19.3	T43.5	89	94	94	89	86	84	78	64	-	
15	AX80AG-473	45°	1455	149	NAV3	160	-	-	-	11	23	T52.6	91	93	93	89	85	82	77	66	-	
16	AX80AD-483	50°	1455	145	NAV3	160	-	-	-	11	22	T52.6	88	96	92	89	87	84	81	65	-	

Notes relating to the table: The electrical and sound information in the table is **nominal**. Breakout dBA@3m is spherical, free field.

Start currents (sc) are DOL other than for motors of 4kW and above which are Star Delta (T).

Note: All 3 phase fans are suitable for control by Ecosmart, Ecosmart BMS, Ecosmart control or standard inverter. E = Electronic single phase speed controls.

*Insert number for correct phase. 1 = 1 phase, 3 = 3 phase. For ancillaries please refer to page 310.

PERFORMANCE - AXUS LONG CASED AXIAL UNITS - 900MM Ø

900mm Ø 6 Pole/960 rpm

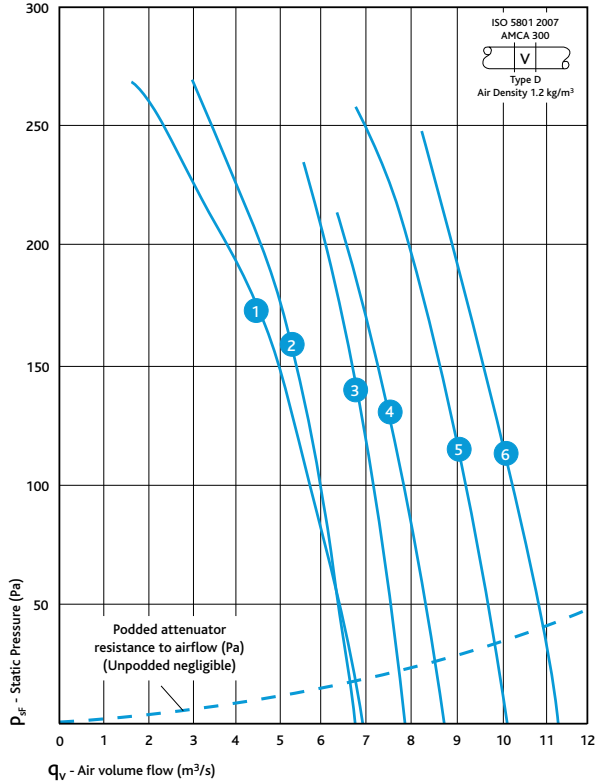

900mm Ø 4 Pole/1440 rpm

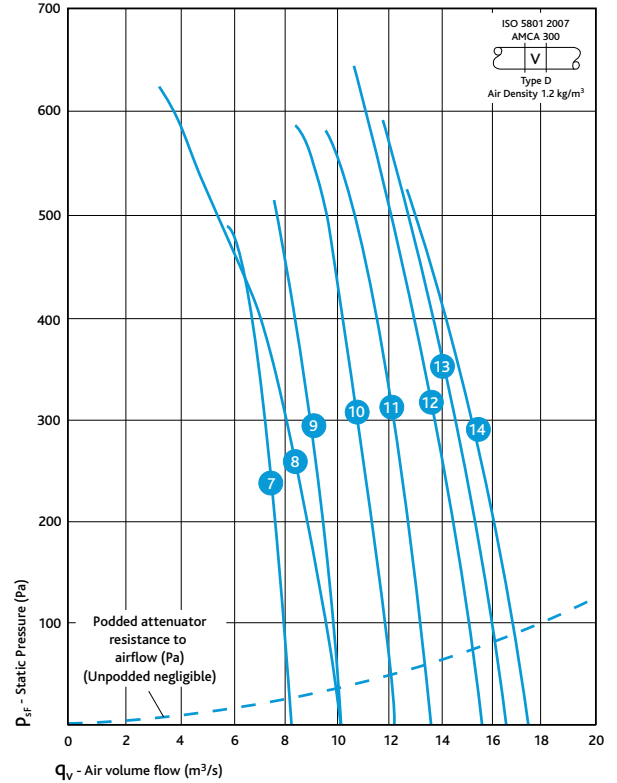

NOTE: THE CURVES ABOVE ARE INDICATIVE OF THE RANGE. A MORE COMPREHENSIVE SELECTION IS AVAILABLE, PLEASE CONTACT NUAIRE TECHNICAL, OR OBTAIN A COPY OF OUR FAN SELECTOR PROGRAMME VIA OUR WEBSITE.

ELECTRICAL & SOUND

Curve No	Unit Code	Blade Angle ^o	Speed RPM	Unit kg	A.V. Set	Motor frame size	3 Phase (400V-50Hz)			In-duct inlet sound power levels dB re 1pW							Breakout dBA @ 3m
							Motor kW	FLC amps	SC amps	Octave band mid frequency Hz							
										125	250	500	1K	2K	4K	8K	
900mm Ø - 6 Pole/960 RPM																	
1	AX90AA-623	30 ^o	910	102	NAV5	100	1.5	4.7	18.5	85	82	80	79	79	74	61	54
2	AX90AG-623	30 ^o	950	133	NAV3	132	3	7.1	41.2	86	88	86	83	82	76	67	59
3	AX90AG-643	35 ^o	970	144	NAV3	132	4	9.4	T21	83	90	85	83	82	78	69	60
4	AX90AG-663	40 ^o	970	144	NAV3	132	4	9.7	T21	84	88	84	81	80	75	68	58
5	AX90AG-673	45 ^o	975	149	NAV3	132	5.5	14.4	T29.4	88	90	87	83	79	75	69	62
6	AX90AG-683	50 ^o	972	174	NAV3	160	7.5	16.5	T24.9	87	92	88	85	82	78	72	61
900mm Ø - 4 Pole/1440 RPM																	
7	AX90AG-413	25 ^o	1450	144	NAV3	132	7.5	15.2	T38.2	90	96	97	93	90	90	82	68
8	AX90AA-423	30 ^o	1445	120	NAV5	132	5.5	11.4	T25.8	85	92	92	90	86	85	78	71
9	AX90AG-423	30 ^o	1455	163	NAV3	160	11	20.5	T52.6	90	94	96	92	89	89	81	69
10	AX90AG-443	35 ^o	1455	163	NAV3	160	11	25.6	T52.6	90	93	96	93	90	89	82	69
11	AX90AG-463	40 ^o	1460	173	NAV3	160	15	30	T72	92	97	97	93	90	88	82	69
12	AX90AG-473	45 ^o	1455	203	NAV4	180	22	42	T104	94	96	97	93	89	85	81	70
13	AX90AG-483	50 ^o	1455	203	NAV4	180	22	45	T104	97	97	99	95	92	88	85	71
14	AX90AD-483	50 ^o	1455	199	NAV4	180	22	42	T104	92	100	96	93	91	88	85	69

Notes relating to the table: The electrical and sound information in the table is nominal. Breakout dBA@3m is spherical, free field. Start currents (sc) are DOL other than for motors of 4kW and above which are Star Delta (T).

Note: All 3 phase fans are suitable for control by Ecosmart, Ecosmart BMS, Ecosmart control or standard inverter.

For ancillaries please refer to page 310.

PERFORMANCE - AXUS LONG CASED AXIAL UNITS - 1000MM Ø

1000mm Ø 6 Pole/960 rpm

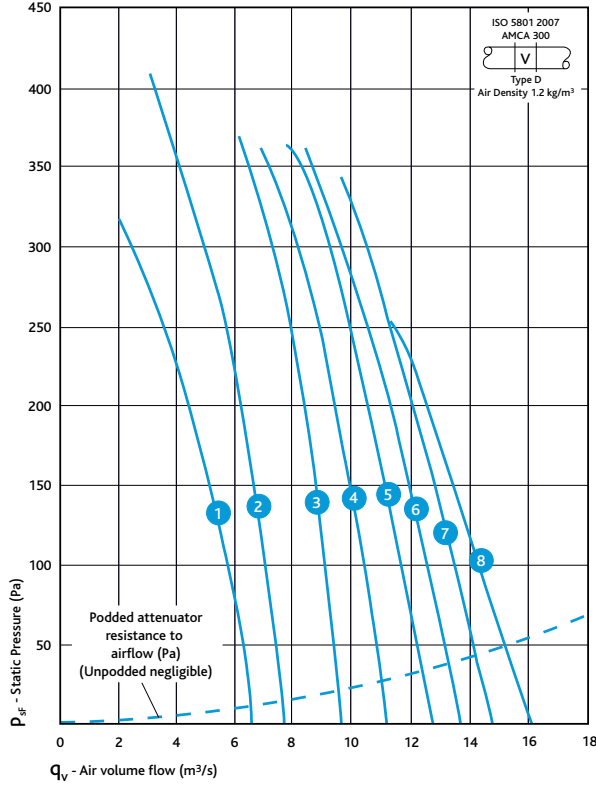

1000mm Ø 4 Pole/1440 rpm

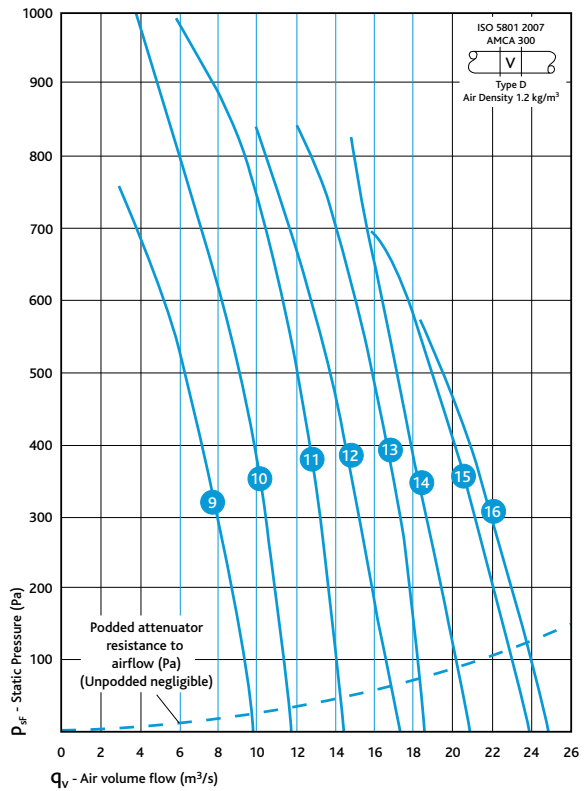

NOTE: THE CURVES ABOVE ARE INDICATIVE OF THE RANGE. A MORE COMPREHENSIVE SELECTION IS AVAILABLE, PLEASE CONTACT NUAIRE TECHNICAL, OR OBTAIN A COPY OF OUR FAN SELECTOR PROGRAMME VIA OUR WEBSITE.

ELECTRICAL & SOUND

Curve No	Unit Code	Blade Angle ^o	Speed RPM	Unit kg	A.V. Set	Motor frame size	3 Phase (400V-50Hz)			In-duct inlet sound power levels dB re 1pW						Breakout dBA @ 3m	
							Motor kW	FLC amps	SC amps	Octave band mid frequency Hz							
										125	250	500	1K	2K	4K	8K	
1000mm Ø - 6 Pole/960 RPM																	
1	AX100AD-613	25 ^o	910	115	NAV5	100	1.5	4.7	18.5	81	89	90	91	85	81	67	63
2	AX100DR-613	25 ^o	950	159	NAV3	132	3	7.9	41.2	94	92	90	86	81	77	69	62
3	AX100DR-623	30 ^o	975	175	NAV3	132	5.5	13.3	T29.4	95	95	89	86	82	78	73	63
4	AX100DR-643	35 ^o	972	202	NAV4	160	7.5	15.9	T24.9	93	89	85	82	78	75	69	61
5	AX100DR-663	40 ^o	972	202	NAV4	160	7.5	16	T24.9	92	91	87	83	79	75	71	60
6	AX100DR-673	45 ^o	970	226	NAV4	160	11	23	T35.3	94	92	89	87	82	78	73	61
7	AX100DR-683	50 ^o	970	226	NAV4	160	11	23.2	T35.3	93	92	90	86	82	79	76	63
8	AX100AG-683	50 ^o	970	210	NAV4	160	11	23	T35.3	101	95	95	92	87	82	76	67
1000mm Ø - 4 Pole/1440 RPM																	
9	AX100AD-413	25 ^o	1445	103	NAV5	132	5.5	12.3	T25.8	89	100	94	91	86	83	77	68
10	AX100DR-413	25 ^o	1455	176	NAV3	160	11	23	T53	98	99	100	97	92	89	83	72
11	AX100DR-423	30 ^o	1460	184	NAV4	160	15	30.5	T72	98	103	99	95	91	88	83	72
12	AX100DR-443	35 ^o	1460	206	NAV4	180	18.5	37.2	T85	96	105	97	94	91	88	84	74
13	AX100DB-443	35 ^o	1455	237	NAV4	180	22	52	T104	96	104	98	95	90	87	82	72
14	AX100DB-463	40 ^o	1465	309	NAV6	200	30	62	T119	99	105	100	95	92	90	87	73
15	AX100CX-473	45 ^o	1465	289	NAV6	200	30	60	T119	101	95	94	91	87	82	76	67
16	AX100CX-483	50 ^o	1470	324	NAV6	200	37	70	T147	101	95	97	94	90	85	79	70

Notes relating to the table: The electrical and sound information in the table is nominal. Breakout dBA@3m is spherical, free field.

Start currents (sc) are DOL other than for motors of 4kW and above which are Star Delta (T).

Note: All 3 phase fans are suitable for control by Ecosmart, Ecosmart BMS, Ecosmart control or standard inverter.

For ancillaries please refer to page 310.

PERFORMANCE - AXUS LONG CASED AXIAL UNITS - 1120MM Ø

1120mm Ø 6 Pole/960 rpm

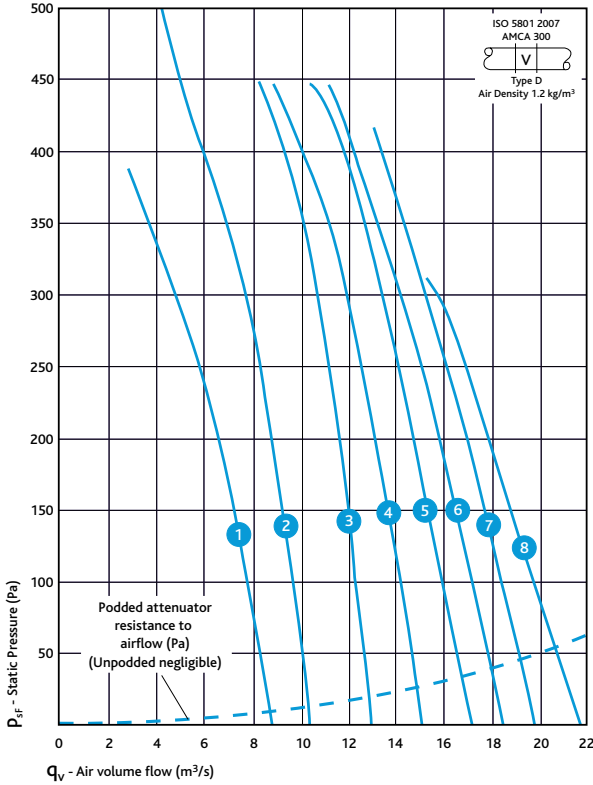

1120mm Ø 4 Pole/1440 rpm

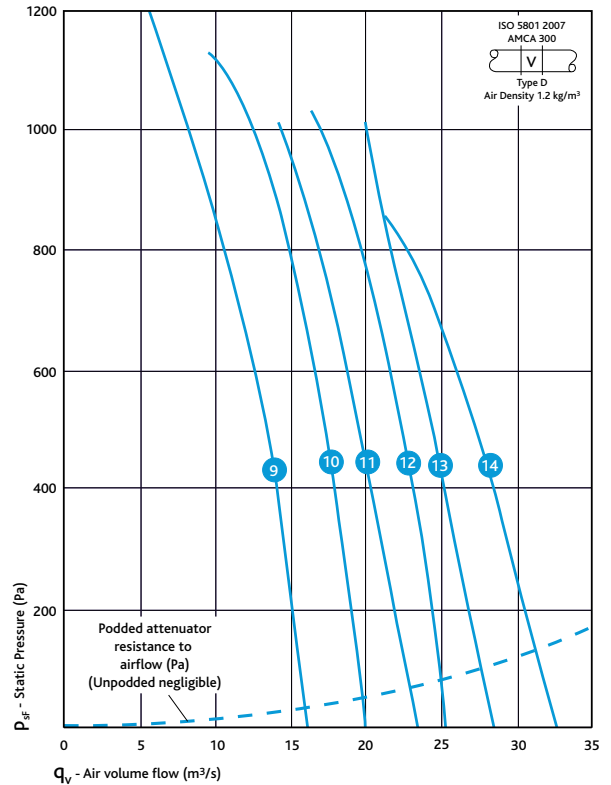

NOTE: THE CURVES ABOVE ARE INDICATIVE OF THE RANGE. A MORE COMPREHENSIVE SELECTION IS AVAILABLE, PLEASE CONTACT NUAIRE TECHNICAL, OR OBTAIN A COPY OF OUR FAN SELECTOR PROGRAMME VIA OUR WEBSITE.

ELECTRICAL & SOUND

Curve No	Unit Code	Blade Angle ^o	Speed RPM	Unit kg	A.V. Set	Motor frame size	3 Phase (400V-50Hz)			In-duct inlet sound power levels dB re 1pW						Breakout dBA @ 3m	
							Motor kW	FLC amps	SC amps	Octave band mid frequency Hz							
										125	250	500	1K	2K	4K	8K	
1120mm Ø - 6 Pole/960 RPM																	
1	AX112AD-613	25 ^o	950	174	NAV3	132	3	7.1	41.2	84	93	94	94	88	85	70	67
2	AX112DR-613	25 ^o	975	199	NAV4	132	5.5	13.5	T29.4	98	95	94	89	84	80	73	65
3	AX112DR-623	30 ^o	972	237	NAV4	160	7.5	17.5	T24.9	98	98	93	89	85	82	76	66
4	AX112DR-643	35 ^o	970	261	NAV4	160	11	23	T35.3	96	92	89	85	82	78	73	64
5	AX112DR-663	40 ^o	970	261	NAV4	160	11	25.3	T35.3	96	94	90	87	83	78	74	64
6	AX112DR-673	45 ^o	972	302	NAV6	180	15	31.5	T68	98	95	93	90	86	81	77	65
7	AX112DR-683	50 ^o	975	327	NAV49	200	18.5	37.2	T78	97	96	94	89	85	82	80	66
8	AX112AG-683	50 ^o	972	285	NAV6	180	15	32	T68	104	98	98	95	90	85	79	70
1120mm Ø - 4 Pole/1440 RPM																	
9	AX112DR-413	25 ^o	1460	267	NAV6	180	18.5	37.2	T85	101	103	103	101	95	92	87	75
10	AX112DR-423	30 ^o	1455	277	NAV6	180	22	52	T104	101	106	102	99	94	92	86	75
11	AX112DR-443	35 ^o	1475	372	NAV49	200	37	67	T143	99	109	101	98	94	92	88	78
12	AX112DB-443A	35 ^o	1475	446	NAV50	225	45	89	T171	100	107	102	98	94	91	85	75
13	AX112DB-463A	40 ^o	1480	551	NAV52	250	55	106	T217	100	107	102	98	94	91	85	75
14	AX112CX-473A	45 ^o	1480	530	NAV52	250	55	103	T217	104	98	98	95	90	86	80	71

Notes relating to the table: The electrical and sound information in the table is nominal. Breakout dBA@3m is spherical, free field. Start currents (sc) are DOL other than for motors of 4kW and above which are Star Delta (T).

Note: All 3 phase fans are suitable for control by Ecosmart, Ecosmart BMS, Ecosmart control or standard inverter.

For ancillaries please refer to page 310.

PERFORMANCE - AXUS LONG CASED AXIAL UNITS - 1250MM Ø

1250mm Ø 6 Pole/960 rpm

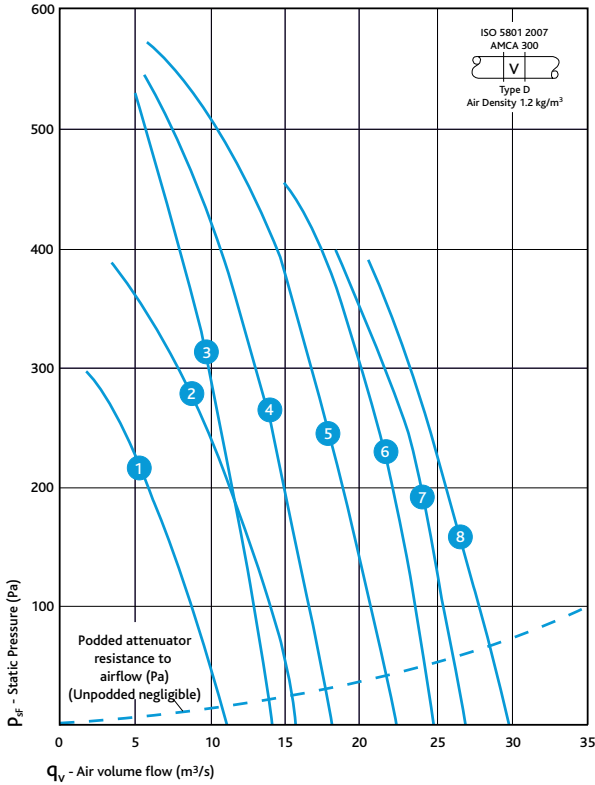

1250mm Ø 4 Pole/1440 rpm

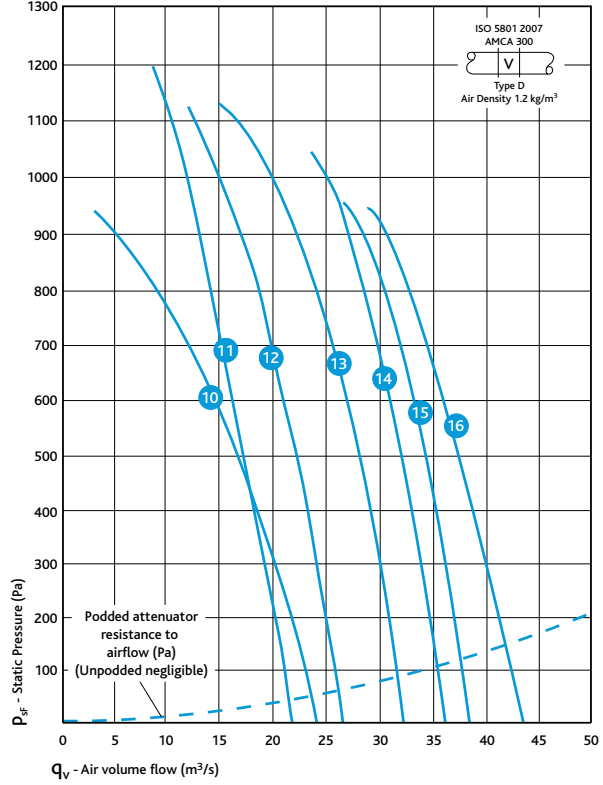

NOTE: THE CURVES ABOVE ARE INDICATIVE OF THE RANGE. A MORE COMPREHENSIVE SELECTION IS AVAILABLE, PLEASE CONTACT NUAIRE TECHNICAL, OR OBTAIN A COPY OF OUR FAN SELECTOR PROGRAMME VIA OUR WEBSITE.

ELECTRICAL & SOUND

Curve No	Unit Code	Blade Angle°	Speed RPM	Unit kg	A.V. Set	Motor frame size	3 Phase (400V-50Hz)			In-duct inlet sound power levels dB re 1pW						Breakout dBA @ 3m	
							Motor kW	FLC amps	SC amps	Octave band mid frequency Hz							
										125	250	500	1K	2K	4K	8K	
1250mm Ø - 6 Pole/960 RPM																	
1	AX125AE-613	25°	950	211	NAV4	132	3	7.1	41.2	94	91	89	87	84	80	73	62
2	AX125DN-623	30°	970	222	NAV4	132	4	9.7	T21	101	96	93	88	82	78	74	66
3	AX125DR-613	25°	972	263	NAV4	160	7.5	15.9	T24.9	92	95	100	97	90	84	75	71
4	AX125DR-623	30°	972	263	NAV4	160	7.5	17.1	T24.9	93	94	100	98	92	85	75	72
5	AX125DR-643	35°	970	287	NAV6	160	11	23.8	T35.3	94	97	101	98	91	84	76	72
6	AX125DR-663	40°	972	317	NAV6	180	15	30.5	T68	96	106	102	99	92	85	79	75
7	AX125DR-673	45°	975	353	NAV49	200	18.5	37.2	T78	99	108	102	97	91	85	80	75
8	AX125DR-683	50°	975	383	NAV49	200	22	42.9	T86	96	99	96	92	88	84	81	68
1250mm Ø - 4 Pole/1440 RPM																	
10	AX125DN-423	30°	1460	246	NAV4	160	15	28.8	T72	98	98	103	107	101	93	88	77
11	AX125DR-413	25°	1455	292	NAV6	180	22	42	T104	95	102	105	109	104	96	90	80
12	AX125DR-423	30°	1465	363	NAV49	200	30	54	T119	96	104	109	110	105	98	91	82
13	AX125DR-443	35°	1475	398	NAV49	225	37	72.5	T143	98	105	113	109	103	97	91	84
14	AX125DR-463	40°	1475	428	NAV50	225	45	92	T171	99	110	110	112	109	102	96	84
15	AX125DR-473	45°	1480	624	NAV53	250	55	109	T217	111	110	111	112	108	102	97	84
16	AX125DR-483	50°	1485	729	NAV54	250	75	137	T306	114	112	112	113	108	102	98	85

Notes relating to the table: The electrical and sound information in the table is nominal. Breakout dBA@3m is spherical, free field.

Start currents (sc) are DOL other than for motors of 4kW and above which are Star Delta (T).

Note: All 3 phase fans are suitable for control by Ecosmart, Ecosmart BMS, Ecosmart control or standard inverter.

For ancillaries please refer to page 310.

DIMENSIONS - AXUS LONG CASED AXIAL FAN

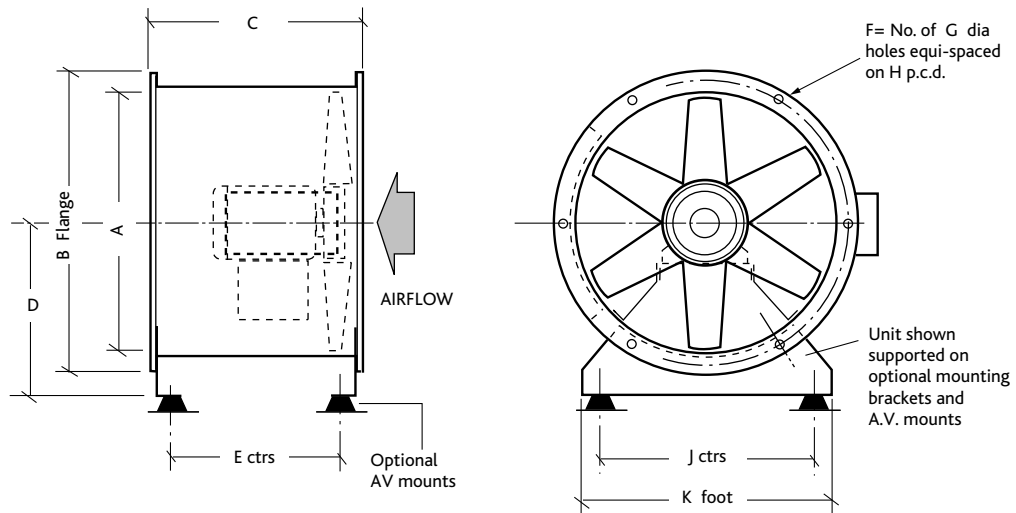

DIMENSIONS (mm) & WEIGHT (kg)

Code	Frame	A	B	C	D	E	F	G	H	J	K	Max. Weight kg
AX25	63-71	250	328	350	170	293	4	12	300	150	245	20
AX31	63-80	315	384	365	210	270	8	12	355	220	315	30
AX35	63-90	350	424	380	240	270	8	12	395	250	345	33
AX40	63-100	400	485	440	270	370	8	12	450	290	385	44
AX45	63-112	450	534	450	300	360	8	12	500	330	425	65
AX50	63-112	500	595	465	340	360	12	12	560	380	475	60
AX50	132	500	595	615	340	510	12	12	560	380	475	88
AX56	71-112	560	652	440	370	360	12	12	620	420	515	55
AX56	132	560	652	615	370	535	12	12	620	420	515	104
AX63	71-112	630	726	480	430	405	12	12	690	500	550	65
AX63	132	630	726	800	430	525	12	12	690	500	550	123
AX63	160-180	630	726	600	430	725	12	12	690	500	550	211
AX71	80-112	710	803	455	470	360	16	12	770	510	590	97
AX71	132	710	803	700	470	605	16	12	770	510	590	138
AX80	80-112	800	904	440	540	360	16	12	860	570	650	87
AX80	132-160	800	904	840	540	760	16	12	860	570	650	150
AX90	90-180	900	1005	740	600	660	16	15	970	610	750	203
AX100	90-180	1000	1106	740	670	630	16	15	1070	710	850	220
AX100	200	1000	1106	850	670	740	16	15	1070	710	850	350
AX100	225	1000	1106	1010	670	900	16	15	1070	710	850	376
AX112	100-160	1120	1228	730	750	620	20	15	1190	890	950	302
AX112	180-200	1120	1228	865	750	755	20	15	1190	890	950	381
AX112	225-250	1120	1240	1010	750	900	20	15	1190	870	950	651
AX125	100-200	1250	1361	865	830	755	20	15	1320	860	1000	350
AX125	225	1250	1361	1010	830	900	20	15	1320	920	1000	729
AX125	250-280	1250	1365	1010	830	900	20	15	1320	860	1000	-

For larger sizes contact Nuair.

CONSULTANTS SPECIFICATION

FAN DESCRIPTION

The ventilation fan Unit shall be configured and arranged as detailed on the drawings and in accordance with the schedule of equipment and shall be of the AXUS axial flow fan as manufactured by Nuair. The units shall be manufactured from galvanised steel to BS EN10142 1991. The case shall be fitted with an external terminal box to IP55.

The fan impeller and motor shall be selected to provide the most energy efficient solution conforming to part L regulations and shall be direct drive with IE2 high efficiency motors to BS5000 as standard and shall be foot mounted TEFC type with IP55 enclosures and class F insulation in accordance with BS4999 part 20. They shall have sealed for life ball bearings. Motors shall be pre-wired to an external electrical terminal box through weatherproof flexible conduit to IP55.

(Note: EExD (flameproof) wiring direct to motor by others). The units shall be suitable for operation in ambient temperatures up to 55°C.

The impeller blades shall be of special aero-foil section giving excellent performance and low noise characteristic manufactured from injection moulded chemically coupled glass reinforced polypropylene or cast aluminium alloy. All units shall be suitable for internal and external operation and can be installed any angle.

The units will be provided complete with matching flanges, flexible connections, anti vibration mounts and all other necessary components to complete the installation and shall be in accordance with the manufacturer's specification.

The unit shall be of the AXUS type as manufactured by Nuair Ltd.

CONTROL SPECIFICATION

The fan unit may be supplied with one of the following control options:-

1. ECOSMART CONTROLS

The compact Ecosmart control system complete with all necessary controls to facilitate the operation of the ventilation system. It shall be come complete with an integral factory fitted Ecosmart PCB which will control the fan unit within the desired design parameters and provide the interface between all external control devices and the unit itself.

The fan unit shall have the following energy saving components integrally mounted, pre-wired to interface with the purpose made PCB, all components pre-wired, configured and factory fitted by the manufacturer: -

- Integral Frequency inverter/speed controller.
- Integral maximum and minimum speed adjustment for commissioning.
- Integral adjustable run on timer.
- Integral BMS interfaces – 0-10V speed adjustment.
- Integral BMS interfaces – Volt free failure and status indication.
- Integral background ventilation switch (trickle switch).
- Multiple IDC sockets for interconnection of sensors or fans using pre-plugged 4-core low voltage cable.

ECOSMART SYSTEM OPERATION

The Ecosmart controls will enable the unit to automatically vary its speed as it receives signals from one of the interconnected sensors. When the signal is received the fan shall either increase speed gradually until the required level is achieved or it will work on a trickle and boost principle. This will then move the fan duty point from trickle/background ventilation rate to the required boost ventilation rate. Both the trickle and boost rates are infinitely variable, easy to adjust and remove the need of a main balancing damper.

2. BMS interfaces

The fan unit shall be provided with the following integrated BMS interfaces

- 0 - 10 volt contacts to provide a full BMS interface. This will enable the following functions:-
 - Switch the unit on/off.
 - Switch from low speed to high speed.
 - Full speed control facility.
- 2 No. Volt free contacts to provide fan run and failure indication to provide system status.
- An integrated commissioning/speed control to accurately commission the system, with minimum and maximum speeds easily adjusted via a miniature dial, as recommended in Part L. This will enable the unit to be configured to run between set parameters thus saving motor power and limiting noise.

CONSULTANTS SPECIFICATION

3. COMMISSIONING SET UP

The fan unit shall be provided with an integrated commissioning/speed control to accurately commission the system, as recommended in Part L, minimum and maximum speeds easily adjusted via miniature dial. The commissioning set up facility directly controls the integrated speed control/frequency inverter.

4. STANDARD CONTROLS











The unit shall be provided with a standard speed control or a standard inverter in accordance with the manufacturers recommendations.

The unit and ancillaries shall be supplied with a 3 years manufacturers warranty. Ecosmart Axus shall have a 5 year warranty.

All equipment shall be as manufactured by Nuaire Ltd.

ANCILLARIES









AXUS AXIAL FANS

Ancillary	Code (mm)	AX25 250	AX31 315	AX35 350	AX40 400	AX45 450	AX50 500	AX56 560	AX63 630	AX71 710	AX80 800	AX90 900	AX100 1000	AX112 1120	AX125 1250
	Description														
Mounting Brackets 	Mounting brackets supplied as pair. manufactured from heavy gauge steel.	CMB25	CMB31	CMB35	CMB40	CMB45	CMB50	CMB56	CMB63	CMB71	CMB80	CMB90	CMB100	CMB112	CMB125
Matching Flange 	Flange supplied as single. Manufactured from galvanised steel.	CMF25	CMF31	CMF35	CMF40	CMF45	CMF50	CMF56	CMF63	CMF71	CMF80	CMF90	CMF100	CMF112	CMF125
Flexible Connector 	Circular without flange. Flexible duct material is flameproof and heat resistant up to 132°C. The material is airtight and waterproof.	CFC25	CFC31	CFC35	CFC40	CFC45	CFC50	CFC56	CFC63	CFC71	CFC80	CMC90	CMC100	CMC112	CMC125
Anti-vibration Mounts 	Resilient rubber, for fan only. For further details on AV Mounts please contact Nuair														
Acoustic Jacket 	Acoustic material laminated with 25mm foam. Complete with straps/buckles for security. For further details on Acoustic Jackets please contact Nuair														
Attenuator 	Standard, Long, podded & long podded options.	CA25S CA25L CA25P CA25LP	CA31S CA31L CA31P CA31LP	CA35S CA35L CA35P CA35LP	CA40S CA40L CA40P CA40LP	CA45S CA45L CA45P CA45LP	CA50S CA50L CA50P CA50LP	CA56S CA56L CA56P CA56LP	CA63S CA63L CA63P CA63LP	CA71S CA71L CA71P CA71LP	CA80S CA80L CA80P CA80LP	CA90S CA90L CA90P CA90LP	CA100S CA100L CA100P CA100LP	CA112S CA112L CA112P CA112LP	CA125S CA125L CA125P CA125LP
Guard 	Manufactured in heavy gauge galvanised steel with acid zinc plated steel mesh.	CDG25	CDG31	CDG35	CDG40	CDG45	CDG50	CDG56	CDG63	CDG71	CDG80	CDG90	CDG100	CDG112	CDG125
Inlet Cone 	manufactured in heavy gauge galvanised steel with a single bolted flange.	CIC25	CIC31	CIC35	CIC40	CIC45	CIC50	CIC56	CIC63	CIC71	CIC80	CIC90	CIC100	CIC112	CIC125
Backdraft Damper 	Gravity operated damper manufactured from heavy gauge galvanised steel with pair of bolted flanges.	CBD25	CBD31	CBD35	CBD40	CBD45	CBD50	CBD56	CBD63	CBD71	CBD80	CBD90	CBD100	CBD112	CBD125
Controls 	Choice of Inverter, electronic or transformer speed controls available. For further details on Controls please contact Nuair														

See page 310 for ancillaries

ANCILLARIES

BIFURCATED AXIAL FANS

Ancillary	Code (mm)	AXB31 315	AXB35 350	AXB40 400	AXB45 450	AXB50 500	AXB56 560	AXB63 630	AXB71 710	AXB80 800	AXB90 900	AXB100 1000
Description												
Mounting Brackets 	Mounting brackets supplied as pair. manufactured from heavy gauge steel.	CMB31	CMB35	CMB40	CMB45	CMB50	CMB56	CMB63	CMB71	CMB80	CMB90	CMB100
Matching Flange 	Flange supplied as single. Manufactured from galvanised steel.	CMF31	CMF35	CMF40	CMF45	CMF50	CMF56	CMF63	CMF71	CMF80	CMF90	CMF100
Flexible Connector 	Circular without flange. Flexible duct material is flameproof and heat resistant up to 132°C. The material is airtight and waterproof.	CFC31	CFC35	CFC40	CFC45	CFC50	CFC56	CFC63	CFC71	CFC80	CFC90	CFC100
Anti-vibration Mounts 	Resilient rubber, for fan only.	For further details on AV Mounts please contact Nuair										
Attenuator 	Standard, Long, podded & long podded options. CA31LP CA35LP CA40LP CA45LP	CA31S CA31L CA31P CA35LP	CA35S CA35L CA35P CA40LP	CA40S CA40L CA40P CA45LP	CA45S CA45L CA45P CA50LP	CA50S CA50L CA50P CA56LP	CA56S CA56L CA56P CA63LP	CA63S CA63L CA63P CA71LP	CA71S CA71L CA71P CA80LP	CA80S CA80L CA80P CA90LP	CA90S CA90L CA90P CA100LP	CA100S CA100L CA100P
Guard 	Manufactured in heavy gauge galvanised steel with acid zinc plated steel mesh.	CDG31	CDG35	CDG40	CDG45	CDG50	CDG56	CDG63	CDG71	CDG80	CDG90	CDG100
Inlet Cone 	manufactured in heavy gauge galvanised steel with a single bolted flange.	CIC31	CIC35	CIC40	CIC45	CIC50	CIC56	CIC63	CIC71	CIC80	CIC90	CIC100
Backdraft Damper 	Gravity operated damper manufactured from heavy gauge galvanised steel with pair of bolted flanges.	CBD31	CBD35	CBD40	CBD45	CBD50	CBD56	CBD63	CBD71	CBD80	CBD90	CBD100
Controls 	Choice of Inverter.	For further details on Controls please contact Nuair										

See page 310 for ancillaries

ANCILLARIES FOR AXIAL FANS - DETAILS

Mounting Brackets

The AXUS mounting brackets are manufactured from heavy gauge galvanised steel and are supplied in pairs. (See table 1 for dimensions).

Typical Code: CMB100 (100 = fan diameter in cm).

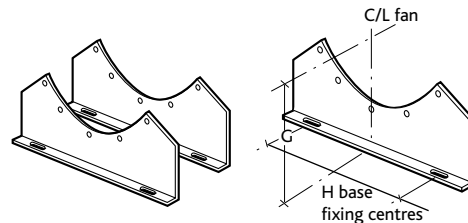

Matching Flange (Single)

Manufactured from galvanised steel matching flanges are supplied individually. (See table 1 for dimensions and weights).

Typical code: CMF100 (100 = fan diameter in cm).

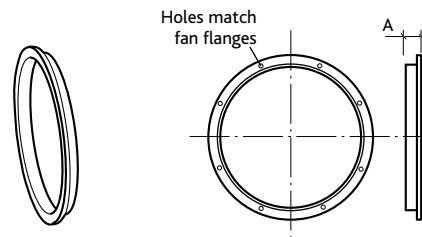

Flexible Connector (Single)

Circular without flanges. Flexible duct material is flameproof and resistant to heat up to 132°C/400°C, chemicals, ozone, oil and grease. The material is airtight, waterproof and tested to BS476 Part 7.

(See table 1 for dimensions and weights).

(Supplied complete with fixing straps).

Typical Code: CFC100 (100 = fan diameter in cm) - 132°C.

CFCH100 (100 = fan diameter in cm) - 400°C.

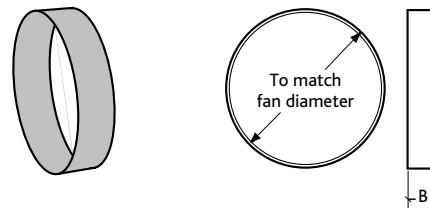

Guard (Single)

Manufactured from heavy gauge galvanised steel and acid zinc plated steel mesh.

(See table 1 for dimensions and weights). Standard Accessory Losses (k).

Flat type • Finger guard 0.4.

Typical Code: CGD100 (100 = fan diameter in cm)

Pressure Drop (Pa) = 0.6 x k x Velocity (m/s).

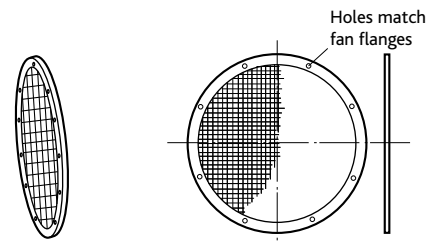

Inlet Cone (Single)

Manufactured in heavy gauge galvanised steel with a single bolted flange.

(See table 1 for dimensions and weights).

Standard Accessory Losses (k).

Low loss • inlet cone 0.38.

Typical Code: CIC100 (100 = fan diameter in cm)

Pressure Drop (Pa) = 0.6 x k x Velocity (m/s).

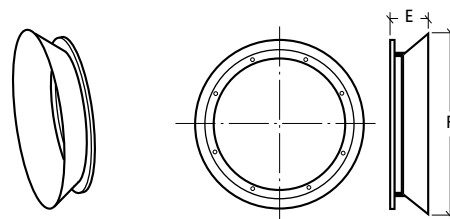

Backdraught Damper (Single)

Gravity operated backdraught damper, manufactured from heavy gauge galvanised steel with a pair of bolted flanges.

(See table 1 for dimensions and weights).

Standard Accessory Losses (k) (Air stream operated) 0.4

Typical Code: CBD100 (100 = fan diameter in cm) - 132°C

(For horizontal mounting only).

Pressure Drop (Pa) = 0.6 x k x Velocity (m/s).

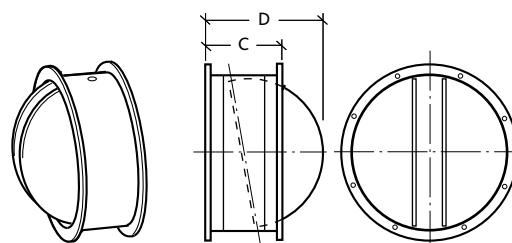

ANCILLARIES FOR AXIAL FANS - DETAILS CONT.

TABLE 1 DIMENSIONS (mm) & WEIGHTS (kg)

Fan Ø	A	B	C	D	E	F	G	H	Inlet Guard Weight kg	B/draught cone Weight kg	Damper Weight kg
250mm	65	150	350	350	85	355	170	150	0.4	1.5	6
310mm	65	150	350	350	85	405	210	220	0.5	2	7.5
350mm	65	150	350	350	90	460	240	250	1	2	9
400mm	65	150	350	350	90	520	270	290	1.5	3	11
450mm	65	150	350	350	90	580	300	330	1.7	4	14
500mm	65	150	350	350	100	650	340	380	2.3	5	16.5
560mm	65	150	350	360	100	700	370	420	2.8	6	20
630mm	65	150	350	400	130	830	430	500	3.2	9	22.5
710mm	65	150	350	440	170	920	470	540	3.7	11	27.5
800mm	65	150	350	470	200	1050	540	590	4	13	35
900mm	65	150	350	520	220	1180	600	670	7	20	55
1000mm	65	150	350	580	230	1300	670	770	7	23	66.5
1120mm	65	150	350	920	260	1450	750	870	8	32	80
1250mm	65	150	350	985	300	1600	830	920	8	40	88

Anti Vibration Mountings

Supplied as a set of 4. To select match isolated assembly weight to max Supporting weight shown on right.

Typical code: NAV1 - Resilient Rubber NAV49 - Spring type.

DIMENSIONS (mm) & WEIGHTS (kg)

Code	Type	B	C	Max Supporting Weight kg
NAV1	Rubber	30	50	20.0
NAV2	Rubber	40	75	80.0
NAV3	Rubber	40	75	180.0
NAV4	Rubber	40	75	260.0
NAV5	Rubber	40	75	130.0
NAV6	Rubber	50	100	320.0
NAV49	Spring	77	76	400.0
NAV50	Spring	77	76	480.0
NAV51	Spring	77	76	520.0
NAV52	Spring	87	127	600.0
NAV53	Spring	87	127	700.0
NAV54	Spring	87	127	800.0
NAV55	Spring	87	127	950.0
NAV56	Spring	87	127	1110.0
NAV57	Spring	87	127	1270.0
NAV58	Spring	87	127	1430.0

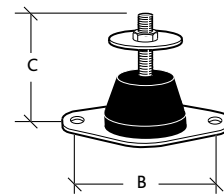

NAV1-5
Resilient Rubber

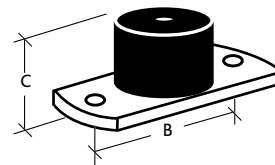

NAV6
Resilient Rubber

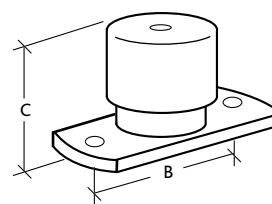

NAV49-58
Spring

IN-LINE CIRCULAR ATTENUATORS

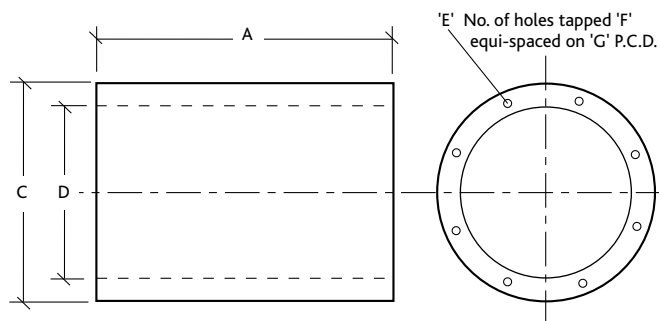

Attenuators and 'Pods' (when fitted) shall be rigidly constructed from galvanised steel, internally lined with sound absorbing material not less than 100mm thick retained by galvanised steel perforated sheet. Attenuator 'end faces' shall be drilled and tapped to match the flange details of the associated fan.

Attenuator 'sound absorbing material' shall be chemically inert, non-combustible, non-hygroscopic and vermin resistant.

Attenuator shall be tested in accordance with BS4718:1971 ASTME 477.

Application: All attenuators shall be suitable for internal and external use at any installed angle.

Note: Podded attenuators with higher acoustic performance and other specifications are available. Please contact Nuair Technical for details.

Standard Un-podded

PERFORMANCE, DIMENSIONS (mm) & WEIGHTS (kg)

Dia.	Unit Code	Type	Dynamic Attenuation								Dimensions & Weights						Weight kg
			Octave band mid frequency (Hz)								A	C	D	E	F	G	
			125	250	500	1K	2K	4K	8K								
250mm	CA25S	Standard Un-podded	-1	-2	-4	-7	-9	-7	-5	250	450	250	4	M8	300	6.0	
315mm	CA31S	Standard Un-podded	-1	-2	-4	-7	-9	-7	-5	315	515	315	8	M8	355	8.0	
350mm	CA35S	Standard Un-podded	-1	-2	-4	-7	-9	-7	-5	355	555	355	8	M8	395	11.0	
400mm	CA40S	Standard Un-podded	-2	-3	-5	-7	-9	-6	-5	400	600	400	8	M10	450	16.0	
450mm	CA45S	Standard Un-podded	-2	-3	-6	-7	-8	-6	-5	450	650	450	8	M10	500	20.0	
500mm	CA50S	Standard Un-podded	-2	-3	-6	-8	-8	-6	-4	500	700	500	12	M10	560	23.0	
560mm	CA56S	Standard Un-podded	-2	-4	-7	-8	-8	-5	-4	560	760	560	12	M10	620	25.0	
630mm	CA63S	Standard Un-podded	-2	-4	-8	-9	-8	-5	-4	630	830	630	12	M10	690	30.0	
710mm	CA71S	Standard Un-podded	-3	-5	-8	-9	-7	-5	-4	710	910	710	16	M10	770	34.0	
800mm	CA80S	Standard Un-podded	-3	-5	-9	-8	-7	-4	-3	800	1000	800	16	M10	860	73.0	
900mm	CA90S	Standard Un-podded	-3	-6	-9	-8	-6	-4	-2	900	1100	900	16	M12	970	92.0	
1000mm	CA100S	Standard Un-podded	-3	-6	-9	-8	-6	-4	-2	1000	1200	1000	16	M12	1070	111.0	
1120mm	CA112S	Standard Un-podded	-4	-6	-9	-7	-6	-3	-2	1120	1320	1120	20	M12	1190	143.0	
1250mm	CA125S	Standard Un-podded	-4	-7	-9	-7	-5	-3	-2	1250	1450	1250	20	M12	1320	188.0	

Note: Pressure drop negligible.

Long Un-podded

PERFORMANCE, DIMENSIONS (mm) & WEIGHTS (kg)

Dia.	Unit Code	Type	Dynamic Attenuation								Dimensions & Weights						Weight kg
			Octave band mid frequency (Hz)								A	C	D	E	F	G	
			125	250	500	1K	2K	4K	8K								
250mm	CA25L	Long - Un-podded	-2	-3	-6	-12	-15	-13	-9	500	450	250	4	M8	300	11.0	
315mm	CA31L	Long - Un-podded	-2	-3	-6	-12	-15	-13	-9	630	515	315	8	M8	355	15.0	
350mm	CA35L	Long - Un-podded	-2	-3	-6	-12	-15	-12	-8	710	555	355	8	M8	395	21.0	
400mm	CA40L	Long - Un-podded	-3	-3	-7	-13	-14	-12	-8	800	600	400	8	M10	450	30.0	
450mm	CA45L	Long - Un-podded	-3	-4	-8	-13	-14	-11	-7	900	650	450	8	M10	500	38.0	
500mm	CA50L	Long - Un-podded	-3	-4	-10	-14	-13	-10	-7	1000	700	500	12	M10	560	42.0	
560mm	CA56L	Long - Un-podded	-3	-5	-12	-14	-13	-10	-7	1120	760	560	12	M10	620	47.0	
630mm	CA63L	Long - Un-podded	-3	-6	-13	-15	-13	-9	-6	1260	830	630	12	M10	690	56.0	
710mm	CA71L	Long - Un-podded	-4	-6	-13	-15	-12	-9	-6	1420	910	710	16	M10	770	63.0	
800mm	CA80L	Long - Un-podded	-4	-8	-14	-14	-11	-8	-5	1600	1000	800	16	M10	860	133.0	
900mm	CA90L	Long - Un-podded	-5	-10	-15	-14	-10	-6	-3	1800	1100	900	16	M12	970	166.0	
1000mm	CA100L	Long - Un-podded	-6	-11	-15	-14	-10	-6	-3	2000	1200	1000	16	M12	1070	203.0	
1120mm	CA112L	Long - Un-podded	-6	-11	-15	-13	-10	-6	-3	2240	1320	1120	20	M12	1190	261.0	
1250mm	CA125L	Long - Un-podded	-6	-12	-15	-12	-9	-5	-3	2500	1450	1250	20	M12	1320	343.0	

Note: Pressure drop negligible.

CIRCULAR ATTENUATORS

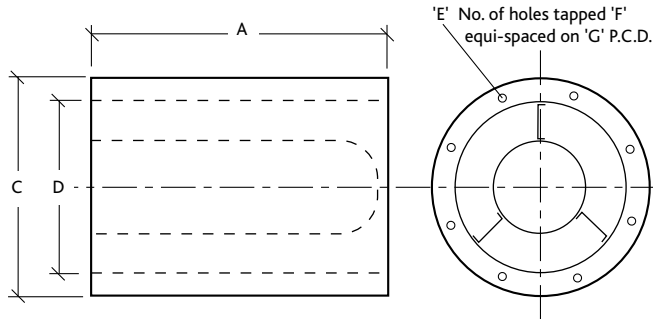

Standard Podded

PERFORMANCE, DIMENSIONS (mm) & WEIGHTS (kg)																		
Dia.	Unit Code	Type	Dynamic Attenuation								Dimensions & Weights							
			Octave band mid frequency (Hz)								A	C	D	E	F	G	Weight kg	Z
			125	250	500	1K	2K	4K	8K									
250mm	CA25SP	Standard - Podded	-2	-5	-13	-16	-17	-11	-8	250	450	250	4	M8	300	8.0	82	
315mm	CA31SP	Standard - Podded	-3	-6	-14	-16	-17	-11	-8	315	515	315	8	M8	355	12.0	26.6	
350mm	CA35SP	Standard - Podded	-3	-6	-14	-17	-17	-11	-8	355	555	355	8	M8	395	17.0	19.7	
400mm	CA40SP	Standard - Podded	-3	-7	-14	-18	-16	-11	-8	400	600	400	8	M10	450	23.0	8.2	
450mm	CA45SP	Standard - Podded	-4	-7	-15	-18	-16	-11	-8	450	650	450	8	M10	500	30.0	6.2	
500mm	CA50SP	Standard - Podded	-4	-8	-15	-19	-15	-11	-8	500	700	500	12	M10	560	33.0	4.0	
560mm	CA56SP	Standard - Podded	-5	-8	-16	-21	-14	-11	-8	560	760	560	12	M10	620	37.0	2.7	
630mm	CA63SP	Standard - Podded	-5	-8	-16	-21	-14	-11	-8	630	830	630	12	M10	690	44.0	1.5	
710mm	CA71SP	Standard - Podded	-6	-9	-17	-20	-14	-11	-9	710	910	710	16	M10	770	50.0	0.9	
800mm	CA80SP	Standard - Podded	-6	-9	-18	-18	-14	-11	-9	800	1000	800	16	M10	860	105.0	0.55	
900mm	CA90SP	Standard - Podded	-7	-10	-19	-17	-15	-11	-10	900	1100	900	16	M12	970	132.0	0.31	
1000mm	CA100SP	Standard - Podded	-7	-11	-19	-17	-14	-11	-10	1000	1200	1000	16	M12	1070	160.0	0.22	
1120mm	CA112SP	Standard - Podded	-8	-12	-20	-17	-13	-11	-10	1120	1320	1120	20	M12	1190	206.0	0.13	
1250mm	CA125SP	Standard - Podded	-8	-12	-20	-17	-13	-11	-10	1250	1450	1250	20	M12	1320	269.0	0.08	

Long Podded

PERFORMANCE, DIMENSIONS (mm) & WEIGHTS (kg)																		
Dia.	Unit Code	Type	Dynamic Attenuation								Dimensions & Weights							
			Octave band mid frequency (Hz)								A	C	D	E	F	G	Weight kg	Z
			125	250	500	1K	2K	4K	8K									
250mm	CA25LP	Long - Podded	-4	-10	-21	-27	-29	-19	-12	500	450	250	4	M8	300	16.0	82	
315mm	CA31LP	Long - Podded	-5	-10	-23	-27	-29	-19	-13	630	515	315	8	M8	355	22.0	26.6	
350mm	CA35LP	Long - Podded	-5	-11	-23	-28	-29	-20	-14	710	555	355	8	M8	395	31.0	19.7	
400mm	CA40LP	Long - Podded	-6	-11	-24	-29	-27	-20	-15	800	600	400	8	M10	450	43.0	8.2	
450mm	CA45LP	Long - Podded	-6	-12	-24	-30	-27	-21	-15	900	650	450	8	M10	500	55.0	6.2	
500mm	CA50LP	Long - Podded	-7	-12	-25	-32	-26	-21	-17	1000	700	500	12	M10	560	61.0	4.0	
560mm	CA56LP	Long - Podded	-8	-13	-26	-34	-25	-22	-18	1120	760	560	12	M10	620	68.0	2.7	
630mm	CA63LP	Long - Podded	-8	-13	-26	-34	-25	-22	-18	1260	830	630	12	M10	690	80.0	1.5	
710mm	CA71LP	Long - Podded	-9	-14	-27	-32	-25	-21	-18	1420	910	710	16	M10	770	91.0	0.9	
800mm	CA80LP	Long - Podded	-10	-15	-29	-30	-25	-20	-17	1600	1000	800	16	M10	860	191.0	0.55	
900mm	CA90LP	Long - Podded	-11	-16	-31	-29	-25	-20	-17	1800	1100	900	16	M12	970	241.0	0.31	
1000mm	CA100LP	Long - Podded	-12	-17	-32	-29	-23	-19	-17	2000	1200	1000	16	M12	1070	291.0	0.22	
1120mm	CA112LP	Long - Podded	-14	-18	-33	-29	-22	-18	-16	2240	1320	1120	20	M12	1190	373.0	0.13	
1250mm	CA125LP	Long - Podded	-14	-18	-33	-29	-22	-18	-16	2500	1450	1250	20	M12	1320	490.0	0.081	

Note: Air pressure drop of attenuator (Pa) = Z x Q² where Z = Factor listed in table above Q = air volume flow rate (m³/s).

WIRING - AXUS AXIAL FAN

Single phase units

(Single phase units - 3 wire supply)

Single Speed 1 phase

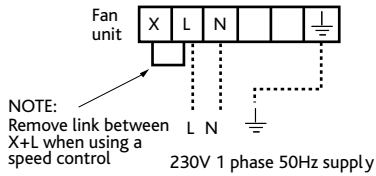

Speed Control, ELECTRONIC 1 phase

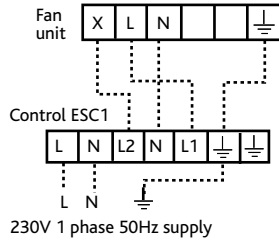

Speed Control, TRANSFORMER 1 phase

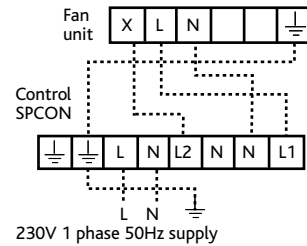

Three phase units

Single Speed 3 phase (below 4kW)

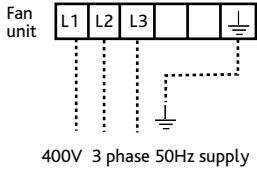

3 phase for connection to a STAR /DELTA STARTER (4kW and above)

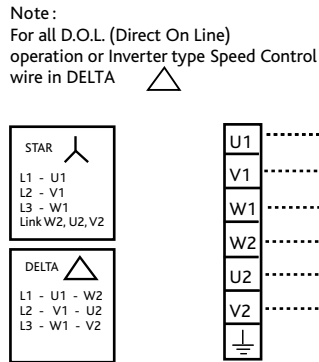

400V 3 phase 50Hz supply

2 Speed TAP/PAM Wound Motors (D.O.L.starting both speeds)

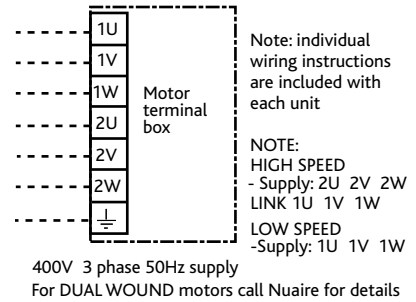

400V 3 phase 50Hz supply
For DUAL WOUND motors call Nuair for details

3 phase for DOL STARTING (4kW and above)

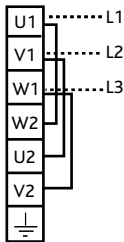

400V 3 phase 50Hz supply

Matched Frequency Inverter

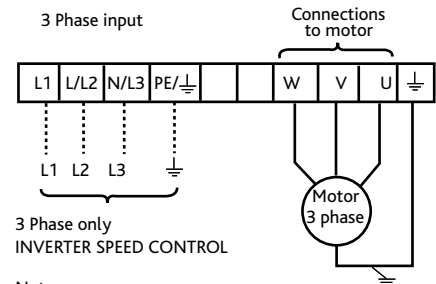

3 Phase only
INVERTER SPEED CONTROL

Notes:
Total length of motor leads should not exceed 50 metres. If a screened motor cable is used, maximum length should be 25 metres. Consult our Technical Department if you wish to use longer leads.
Inverters are configured to suit specific fans and control applications as described on the Customer Order free of charge.

400V 3 phase 50Hz supply

SPEED CONTROLS TABLES

Unit Code	Electronic Speed Control	Unit Code	Electronic Speed Control
1 AX31X-461	NSC1-3A	21 AX45S-481	NSC1-6A
2 AX31F-441	NSC1-3A	22 AX45P-471	NSC1-6A
3 AX31F-451	NSC1-3A	23 AX45P-481	NSC1-6A
4 AX31B-451	NSC1-3A	24 AX45D-451	NSC1-6A
5 AX35D-411	NSC1-3A	25 AX50C-411	NSC1-3A
6 AX35X-421	NSC1-3A	26 AX50D-411	NSC1-6A
7 AX35F-431	NSC1-3A	27 AX50P-411	NSC1-6A
8 AX35F-441	NSC1-3A	28 AX50P-421	NSC1-6A
9 AX35F-451	NSC1-3A	29 AX50S-45*	NSC1-10A
10 AX40D-411	NSC1-3A	30 AX56B-411	NSC1-3A
11 AX40I-411	NSC1-3A	31 AX56F-411	NSC1-6A
12 AX40I-421	NSC1-3A	32 AX56S-42*	NSC1-10A
13 AX40I-431	NSC1-6A	33 AX63F-411	NSC1-6A
14 AX40I-441	NSC1-6A	34 AX710-611	NSC1-6A
15 AX40I-451	NSC1-6A	35 AX710-621	NSC1-6A
16 AX45S-411	NSC1-3A	36 AX71P-621	NSC1-6A
17 AX45P-411	NSC1-3A	37 AX71AA-621	NSC1-6A
18 AX45S-431	NSC1-6A	38 AX80O-611	NSC1-6A
19 AX45S-451	NSC1-6A	39 AX80O-621	NSC1-6A
20 AX45S-471	NSC1-6A	40 AX80P-621	NSC1-6A

* refers to code 1 or 3 phase.

CONTROLS

DIMENSIONS (mm) & WEIGHTS (kg)

Fan code	A	B	C	Weight kg	Drill D mm	Pattern E mm
ES-ISC1.2A	230	325	410	6	340	298
ES-ISC2.4A	230	325	410	6	340	298
ES-ISC3.3A	230	325	410	6	340	298
ES-ISC4.1A	230	325	410	6	340	298
ES-ISC5.6A	290	390	455	14	470	373
ES-ISC7.3A	290	390	455	14	470	373
ES-ISC8.8A	290	390	455	14	470	373
ES-ISC12.5A	290	390	455	20	470	373
ES-ISC15.6A	290	390	455	20	470	373
ES-ISC23.1A	290	390	455	20	470	373
ES-ISC38.0A	355	525	805	40	710	510

The Ecosmart Energy Saving Speed Control is designed to control selected Nuair fans and to match the range of integrated Ecosmart control systems. The control is only available for three phase electrical supply.

The case material is of Aluzinc corrosion resistant steel, incorporates a frequency inverter, Ecosmart control board and is directly compatible with the Ecosmart range of user controls, time clocks, 'stats and sensors.

Internal mounting

Please note:

- Select a control by matching the unit full load current with the control code i.e. control code ES-ISC3.3A is suitable for a fan with a maximum full load current of 3.3A. The Inverter overload is pre-set at the rating plate value, if a lower setting is required fit an appropriately sized overload relay or adjust inverter settings.
- The mains power supply to the controller must be appropriately sized and installed via a local isolation switch (by others).

DIMENSIONS

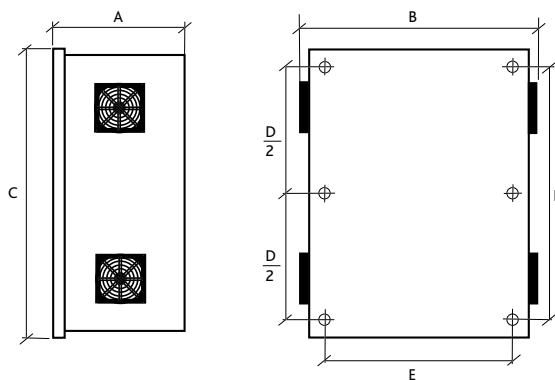

Code descriptions

ES - ISC 2.4A

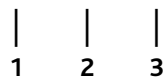

- ES = Ecosmart
- Inverter Speed Control
- Output Current Rating

The isolator must also accommodate the 230V switched live (if used). The mains supply from the Ecosmart controller to the fan must be appropriately sized, not exceeding 30 metres and must be a screened power cable, earthed at both ends.

A four point glanding plate is formed from the base of the control and in order to main EMC compliance, EMC glanding kit is supplied.

- Not suitable for contra rotating/run and standby axial units.
- All integrated sensors plug directly into the control panel.
- Refer to product datasheet No. 671432 for further information.

CONTROLS CONT.

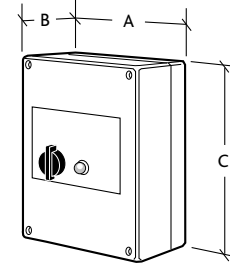
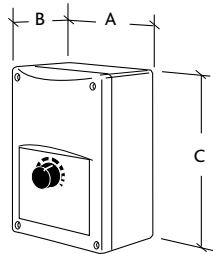

ELECTRONIC SPEED CONTROL (mm)

Dimensions (mm)				
Unit Code	A	B	C	Weight kg
NSC1-3A	83	88	180	0.5
NSC1-6A	115	95	195	0.7
NSC1-10A	115	95	195	0.7

The electronic speed controllers provide infinitely variable speed control from preset minimum to maximum. All models feature a boost start function, which applies maximum power to the motor for a few seconds to prevent motor stalling before returning to selected speed. Wiring to the motor can be either 2-wires or 3-wires control depending on the motor design. The enclosures for ESC1-3A and ESC1-6A are rated to IP45 with the ESC1-10A rated at IP54. All controllers meet LVD and EMC directives for safety and electromagnetic compatibility.

TRANSFORMER SPEED CONTROL (mm)

Single Phase				
Unit Code	A	B	C	Weight kg
SPCON1.5	115	85	180	1.7
SPCON3.5	200	140	280	3.6
SPCON7.5	200	140	280	6.0

Autotransformers having class 'F' insulation are used to provide discrete voltage steps. All models are fitted with suitable fuses for short-circuit protection. The controller casing is manufactured from plastic pre-coated steel or impact resistant polycarbonate. All models are suitable for indoor installations only. All controllers meet LVD and EMC directives for safety and electromagnetic compatibility. Transformer speed controls produce a pure sine wave output resulting in quiet motor operation. Transformer controls are therefore preferred for noise sensitive applications.

DIMENSIONS (MM)

Frame size A inverter and Drill Pattern

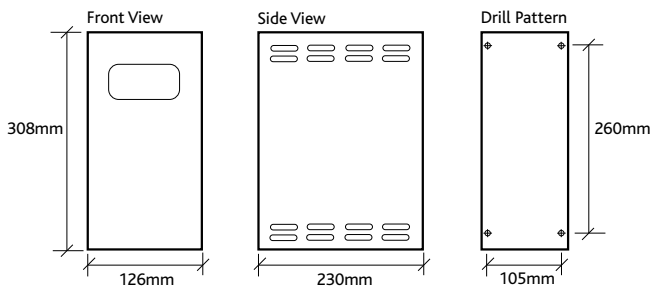

Frame size B Drill Pattern

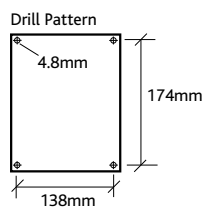

Frame size C Drill Pattern

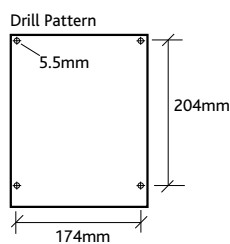

Frame size A inverters codes

3ISC1.2A (image shown)
3ISC1.6A (image shown)
3ISC2.1A (image shown)
3ISC3.0A (image shown)
3ISC4.0A (image shown)
Frame size B inverters codes
3ISC5.9A
3ISC7.7A
3ISC10.2A

Frame size C inverters codes

3ISC13.2A
3ISC15.8A
3ISC18.4A
3ISC26.0A

All inverters are supplied complete with integral class A filters to suppress EMC emissions.
Note: Frame size A inverters are pre assembled into metal enclosures.

Code descriptions

3 ISC 1.2A

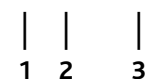

1. 3 Phase
2. Inverter Speed Control
3. Output Current Rating