



# Ecosmart Connect (CO) Control Operation Manual



## 1.0 CONTROLS

The system incorporates a preconfigured BACnet MS/TP enabled controller.

### 1 Connect Controller

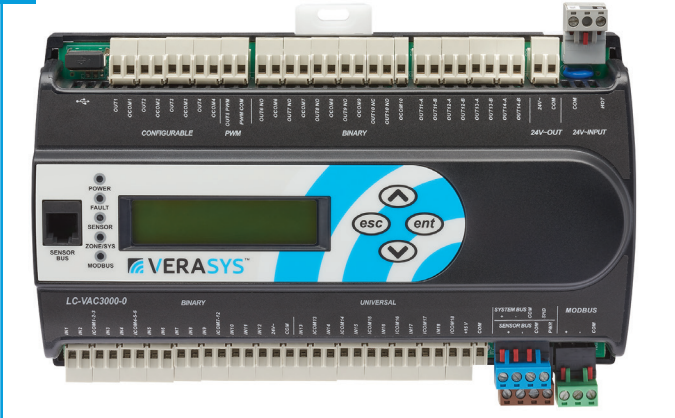

### 1.1 Controllable Items

- Supply Fan
- Extract Fan
- Heat Recovery Bypass Damper (if applicable).
- Thermal Wheel (if applicable).
- Heating Coil (if fitted).
- Cooling Coil (if fitted).
- DX coil (If fitted).
- Inlet Damper (If fitted).
- Exhaust Damper (If fitted).
- Recirculation damper (If fitted).

### 1.2 Enable Signal

The unit can be enabled via the following methods:

- Software switch (ENABLE) via local display or network.
- Volt free input contacts.
- Night Cooling / Summer free-cooling strategy.
- Scheduled via weekly calendar (Schedules are accessed and adjusted via the ESCO-LCD(B) or the MAP gateway device).
- Fan speed override.
- Room module PIR sensor.
- Room module 3-fan speed button (While in low, med or high state).

When the enable signal is removed, the unit will run on for a time defined by the run-on setpoint.

### 1.3 Occupancy Control

Ecosmart Connect control allows the connection of multiple Room Modules which are automatically detected and connect to the controller via a SA (Sensor Actuator) MS/TP bus. See Network Accessory section for more connection details.

### 1.3.1 PIR Room Sensor

When a Room Module PIR sensor is connected via the SA bus, the control will automatically use this as an enable signal by default. There is a non-adjustable minimum run-on time of 15mins for Room Module PIR's. This is in addition to any software run-on times.

### 1.3.2 RM 3-Speed Fan Override (ESCO-TDFS2 Only)

When a RM fan speed override is available it will override fan speed functions. This function overrides any run-on time (except for electric heater heat dissipation). While in override mode, the unit will ignore return air temperature and set the supply air to the setpoint. Multiple fan override sensors are supported with the highest demand taking priority. Whenever a fan-speed override Room Module is connected, the display will automatically show the fan speed status at all times. A timeout can be set for the fan mode to revert back to auto after a predetermined time period. The setting Fan Override Operation and Fan Override Timeout can be adjusted to achieve this.

Mode	Operation	Display
"Auto"	The Controller will ignore the fan speed override. Current Fan speed will still be displayed.	
"Off"	The controller will override all functions and stop the fans.	
"Low"	The fans run at low speed.	
"Medium"	The fans run at medium speed.	
"High"	The fans run at high speed.	

### 1.3.3 RM Occupancy Display

If an RM sensor with occupancy display is connected, it will automatically display the occupancy state as follows.

State	Description	RM Display
Occupied	An enable signal is present i.e. Fans are running.	
Unoccupied	No enable & no trickle i.e. Fans are stopped.	
Standby	No enable signal but fans are trickling.	

### 1.4 Multiple Sensors

Where multiple sensors are connected the following options are available.

State	Description
Temp Sensor Operation	Room module average (default) Return air only Room module & return air average
Setpoint Operation	Last value changed (default) Software setpoint only Last value changed with timeout
Humidity Sensor Operation	Average (default) Max Ignore
CO2 Sensor Operation	Average (default) Max Ignore
Pressure Sensor Operation	Average (default) Max Ignore

### 1.5 Auxiliary Inputs 16 & 17 (0-10V Inputs)

The function of IN16 & IN17 can be set by the network inputs IN16 Function & IN17 Function. The available options are as follows.

Function	Description	Available Ranges
None	The signal is ignored	N/A
Fan Speed Control	A 0-10V input is used as a fan speed demand. 0V = Min Speed 10V = Max Speed	N/A
EGG (Ecosmart Gateway Gadget)	0-10V from the EGG PCB is controls used as a fan speed demand. The optional EGG PCB can be used for backwards compatibility with some Ecosmart Classic sensors.	N/A
0-10V CO2 Sensor	0-10V is scaled as defined by the network input "CO2 0-10V Output Range"	0-2,000ppm 0-4,000ppm 0-5,000ppm 0-10,000ppm 0-20,000ppm
0-10V Temperature Sensor	0-10V is scaled as defined by the network input "Temperature Sensor 0-10V Output Range"	0 - 40°C 0 - 50°C 0 - 80°C 0 - 90°C 0 - 100°C
0-10V Pressure Sensor	0-10V is scaled as defined by the network input "Pressure Sensor"	0 - 25 Pa 0 - 50 Pa 0 - 100 Pa 0 - 300 Pa 0 - 500 Pa 0 - 1000 Pa 0 - 1600 Pa 0 - 2500 Pa 0 - 3000 Pa
0-10V Humidity Sensor	0-10V is scaled to 0-100% humidity	0 - 100% only

### 1.6 Fan Speed Control Input

Once assigned to either input 16 or 17, the 0-10V input is scaled to 0-100% fan speed demand.

### 1.7 CO2 Control

When a CO2 sensor is assigned to the system and an enable signal is received, ventilation will increase fans speeds to reduce CO2 concentration. The target CO2 sensor setpoint can be changed as one of the commissioning setpoints. Room Module CO2 sensors are detected automatically. 0-10V CO2 sensors need to be assigned to input 16 or 17.

### 1.8 Humidity Control

When a humidity sensor is assigned to the system and an enable signals received, ventilation will increase fans speed to reduce humidity. The target humidity setpoint can be changed as one of the commissioning setpoints. Room Module humidity sensors are detected automatically. 0-10V humidity sensors need to be assigned to input 16 or 17.

### 1.9 Constant Pressure Control

On select units an extract air pressure sensor is fitted to IN16 standard. IN16 is disabled by default but constant pressure control can be enabled by setting IN16 function to 0-10v pressure sensor.

When enabled, the unit will increase the fans speeds as required until the pressure differential between the extract air and atmosphere reaches the constant pressure setpoint.

The target pressure setpoint can be changed as one of the commissioning setpoints. Room Module pressure sensors are not available.

### 1.10 Dirty Filter Switch

Where filter differential pressure switches are fitted, these monitor the Extract filter, Supply filters. These are connected into input IN9 & IN10 and will be open circuit on overpressure. The adjustable range is 0.5 to 4mbar and is set by the default to 2mbar.

### 1.11 Configurable Mode (Via Switched Live 2)

The switched live 2 input is a configurable input that can be set to perform a number of functions. The function is set via the network input Configurable Mode SL2.

These functions will include the following:

- **Fan Boost (Default Setting)** - This enables Fan Boost Mode
- **Heat Boost** - The heater function will be enabled. Fan speeds will be increased where necessary to keep supply temp at the heater boost setpoint (Default 35°C).
- **Extract Setback** - When this mode is selected and SL2 is active, the unit will force the extract fan to run at Extract Setback Speed (Commissionable setpoint), regardless of all other demands. Supply fan will operate at the normal speed. If increased demand is required (e.g. via CO2 or 0-10v IN16/17 some other input) the supply fan speed will increase but the extract fan speed will not. This mode can be used when the unit is used in conjunction with a separate air system.

#### 1.11.1 Fan Boost

When the control receives a boost signal, from either the network input "Boost" or "Configurable SL2" configured to boost, the fans will run at their individual boost speeds. Once the signal is removed the fans will run on for a time defined by the boost run-on setpoint. Any demand in excess of the boost speed will be ignored (apart from 3 speed override and purge schedule).

#### 1.11.2 Heat Boost

When the control receives a heat boost signal, from either the network input "Heat Boost" or "Configurable SL2" configured to "heat boost", the heater output will increase to 100%. The fan speed will be increased as required to reach the heat boost setpoint.

1.12 Temperature Control

1.12.1 Supply Temperature Control (Default)

While an enable signal is present, this mode modulates heating, cooling & heat exchanger bypass dampers with the aim of the supply air reaching the temperature setpoint. Heating and cooling outputs will only function if the "Heating Type" or "Cooling Type" network inputs are set to heating or cooling options.

The heat exchange bypass damper operates by calculating the supply air temperature based on the return air temperature, the outside air temperature and the heat exchanger efficiency (e.g. A 13°C outside air temperature with a 23°C return air temperature will give a supply air temperature of 20.5°C).

The control then chooses the damper position which requires the minimal heat/cool tempering in order to achieve the setpoint.

2 Supply Temperature Control - HX Bypass

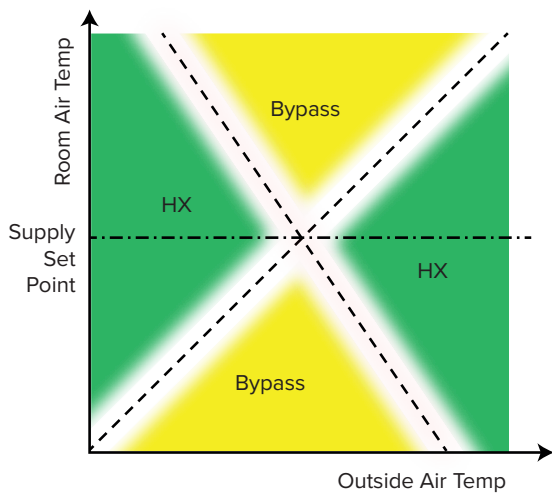

White areas indicate regions where either heat exchanging or bypassing will achieve the same supply temperature

1.12.2 Room Temperature Control

While an enable signal is present, this mode modulates heating, cooling & heat exchanger bypass dampers with the aim of the room air reaching the temperature setpoint. Please note that heating and cooling outputs will only function if the "Heating Type" or "Cooling Type" network inputs are set to heating or cooling options.

When heating or cooling is required achieve the room setpoint, the output of the heat/cool loops are split between ventilation demand or heat/cool demand according to the following graphs. The intermediate "boost" zone is the area in which a small amount of free heating/cooling is available. In this zone, heating/cooling is used to boost the free heating/cooling.

In room temperature control mode, the bypass damper is controlled according to the following chart. A minimum supply air temperature limit is included to stop the heat exchanger being bypassed when the air temp is uncomfortably cold, even though cooling is required. In this case the heat exchanger will temper the air for comfort. The reverse applies for the maximum supply air temperature limit.

If the supply air temperature exits the minimum - maximum supply temperature range, the unit will adjust ventilation, heating or cooling to compensate.

**Room temperature control will only be effective if the heater unit is sized correctly for the space. If the unit is undersized, heating from an external source may be required.**

3 Room Temperature Control - Heating

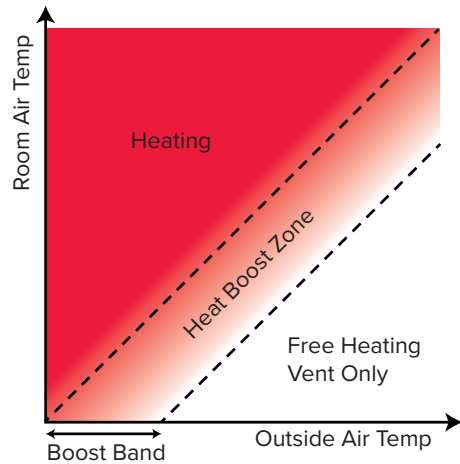

4 Room Temperature Control - Cooling

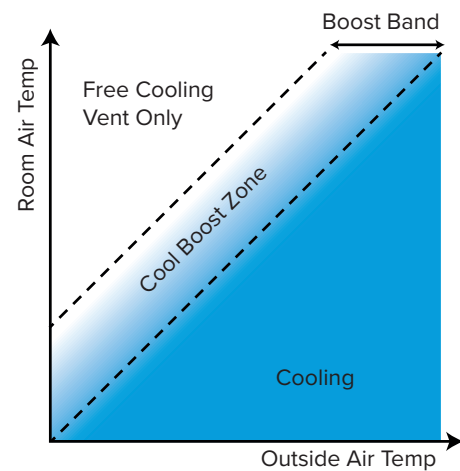

5 Room Temperature Control - HX Bypass

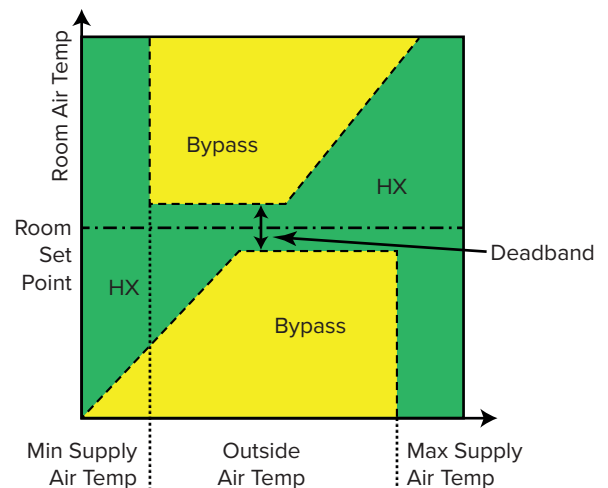

1.12.3 Overrides

When the following conditions occur, the system will temporarily exit "Room Temperature Mode" and enter "Supply Temperature Mode".

- Trickle Mode with no enable signal (Trickle deadband applies).
- Heat Boost Active
- Fan Boost Active
- Purge Mode Active
- 3-Speed override by Room Module

### 1.13 Trickle Mode

When trickle mode is active, the fans will run at their minimum speed even when there is no enable signal. Heating and cooling will also function in this mode if available. While in trickle mode, the unit will function in "Supply Temperature Control Mode" but with a different, wider deadband.

### 1.14 Frost Protection

Should the internal temperature of the unit fall below a value defined in the commissioning variables, the control will override all heating/ cooling logic to open the LPHW or CW control valves, if fitted. This is to allow any protective flow through the heating/ cooling coils. The supply fan will stop and the appropriate frost protection software module will enter an alarm state. This period will last for a minimum of 5 minutes by default. The fault relay will also open. Heat and cool demand relays will operate and the software frost alarm will enter an alarm state.

**Frost protection will only function if the Heating Type or Cooling Type setpoints are set to LPHW or CW.**

### 1.15 Reverse Cycle DX (Optional For BPS Variants)

For units for use with Mitsubishi reverse cycle condenser units, one or more PACIF012B-E Interface boards are fitted inside the control panel. The controller interacts with this board in the following ways:

- Digital Output Heat/Cool selection from VAC relay 8. Another relay is used to split output over multiple boards.
- 0-10°C Heat/Cool demand from VAC OUT4 .
- Faults are monitored via iQ4 input 8 (Alarm circuit 2).

When Mitsubishi Reverse Cycle DX is fitted, this is selected in software by setting the cooling type "Reverse Cycle". A heating type is not required unless another heating type is fitted (e.g. LPHW).

Once this is selected cooling and heating demand will share VAC OUT4 and heat/cool is decided on the state of VAC Relay 8 (Energised = Cool Demand).

For the cases where Reverse Cycle DX and another heating type are both fitted, the schedule object "Reverse Cycle backup Heating" can be set to revert to the other heating option at certain times of the day.

Although the controller outputs a variable 0-10v heating/cooling voltage, the Mitsubishi condenser can only run at 7 discrete levels and so cannot supply an accurate supply air temperature. For this reason, it is recommended that the control is set to operate in room temperature control mode. This will regulate the room air temperature rather than supply air temperature.

The PAC boards are powered from the BPS control, the only connections required to the Outdoor condenser are S2 & S3. For the same reason, SW8-3 must be set to "ON" on the outdoor unit.

The enable run-on time must be set to 3 minutes for reverse cycle units. This is required to keep the compressor running for at least 3 minutes for each period.

### 1.16 Night Cooling / Summer Free Cooling

Once enabled in software, this routine can be set to a network time schedule to cool the fabric of the building at night using only the external air. This mode only functions if the daytime temperature is above the setpoint, cooling is possible and if the cooling air is not too cold.

### 1.17 Purge Mode

Once enabled in software, this routine can be set to a network time schedule to provide a period of increased air change throughout a space. This mode only functions if the inlet air is above a minimum temperature of 12°C. While purge is in progress, the unit will function in "Supply Temperature Control Mode" but with a different, wider deadband.

### 1.18 Hibernate Mode

This mode is available for LPHW and CW units where the valves are required to be driven open in anticipation of a period where the unit is electrically isolated and inactive. When enabled via the network input "Hibernate Mode" this will stop the fans and open all LPHW & CW valves fully. The unit can then be powered down. This mode activation is reset upon power cycle so when restarted the unit will function as normal.

This mode is for periods when the building is left dormant and will stop the coils trapping water and causing a freeze risk. It will be the buildings responsibility to provide freeze-preventative heating during this time. This can also be used for a cleaning or flushing cycle.

### 1.19 Inlet / Outlet Dampers (Optional)

Inlet and outlet dampers are 24vac and controlled by the fan run relay. When energised it gives a 24vac signal to both I/O dampers to open. A fan start delay can be imposed to allow the damper time to open. This is adjustable via display screens or commissioning tools.

When installed, there is the option of connecting the internal damper close switch to the fault circuit alarm circuit 2 (orange wires).

When IO dampers are fitted the software object "IO Damper Fitted" must be set to "Yes". This will cause the software to delay the fans starting for the IO Damper delay period. It will also ignore faults on Alarm Circuit 2 if the fans are stopped and the dampers are closed intentionally. See Internal connection section for physical damper connections.

### 1.20 Trends

The trend logs are used to monitor a sensor reading or setpoint over time. A reading is taken and logged against a time. A reading is taken every 30 seconds, 1000 values are stored for each trend.

### 1.21 Partial Recirculation Damper (Optional)

If a partial recirculation module is fitted, the recirculation damper will open / close via OUT8 according to the following strategy.

If the room temperature is more than 5°C (adjustable via recirc-offset variable) from the setpoint and free-cooling or free-heating is not available then partially recirculate the air. This aids heating and cooling elements and avoids thermal loss from the room.

### 1.22 Alarms

The alarms can be either one of two categories. The LCD will display Emergency Alarm for Critical Alarms & General Alarm for Maintenance alarms.

### 1.22.1 Critical / Emergency Alarm (Latching)

Once in critical alarm state the unit will drive all heating and cooling outputs to 0V. In the event of fan fail other functions continue as normal. The critical alarm is latched and requires power cycle or reset via the “Reset Alarms” variable.

Causes of critical alarm:

- Supply Fan Fail IN1.
- Extract Fan Fail IN2.
- Electric Heater Alarm IN7 (If Fitted).
- Fan Tacho Fail IN8 (If Fitted, this will replace the alarms on IN1 & IN2).

### 1.22.2 Maintenance / General Alarm (Non-Latching)

Once in maintenance alarm state the only action taken is de-energising of the fault relay. Once the trigger is removed, the alarm will reset automatically.

Causes of maintenance alarm:

- Sensor Failure.
- Low supply temperature, default 8°C. This can be set to stop fans if required.
- Frost protection routine active, default 4°C (This only runs if water valves are selected as fitted).
- Excessively high supply temperature reading (This will stop heating).
- Supply Filter dP fault IN9 (if fitted).
- Extract Filter dP fault IN10 (if fitted).
- Condensate Pump - Alarm IN4 (if fitted).
- IO Damper Alarm - Alarm IN3 (if fitted).
- Thermal Wheel Alarm - Alarm IN11 (if fitted).

All alarms have a hold off period set by the setpoint “Alarm delay”.

### 1.22.3 Thermal Trip

In case of software failure, as a final resort, the electric heater is protected by a fail-safe thermal overload switch. This switch disables the heater controller via a contactor once the temperature reaches 80°C. When this occurs, the critical alarm will latch in software and the supply contactor will latch in the off position.

**Once the unit cools, the contactor will remain latched off until power cycle.**

### 1.23 Configurable Analogue Output 4 (OUT4)

OUT4 is a configurable analogue output which can be set to the following functions via the multi-state object “OUT4 Mode”.

- Cooling Demand (Default Setting)**  
This will provide a standard 0-10V cooling output. This output will only function if a cooling type is selected.
- ES Classic BMS**  
This option will provide a 0-10v ESClassic BMS output based on ventilation demand. This can then be used in conjunction with the fan run relay to run multiple slave Classic units from a master Connect control.

The type of BMS output can be selected by the multi-state object ‘ECS BMS Thermic Output’.

- Auto** - The BMS output will switch between heating and cooling depending on outdoor air temperature.
- None** - The unit will only supply ‘Vent Only’ voltages.
- Heating** - The unit will only supply ‘Heating’ voltages.
- Cooling** - The unit will only supply ‘Cooling’ voltages.

### 1.23.1 ES Classic BMS Output Table

Function	Ventilation Only	Cooling	Heating
Off / Trickle	0.25V	-	-
Speed 1	0.5V	0.75V	1V
Speed 2	1.5V	1.75V	2V
Speed 3	2.5V	2.75V	3V
Speed 4	3.5V	3.75V	4V
Speed 5	4.5V	4.75V	5V
Speed 6	5.5V	5.75V	6V
Speed 7	6.5V	6.75V	7V
Speed 8	7.5V	7.75V	8V
Speed 9	8.5V	8.75V	9V
Speed 10	9.5V	9.75V	10V

### 1.24 Fire Alarm

Once the Fire Alarm object is switched to the Alarm State, all fans, heating and cooling elements will stop instantly. The fault relay will de-energise and a fault message will be sent to the ESCO-LCD(B). Once the fire alarm status is released, the units will continue running automatically.

### 1.25 BACnet Overview

BACnet is a data communication protocol for Building Automation and Control Networks. It allows compatibility between devices of different manufacturers. In BACnet, any device on the network can browse the network and discover devices.

### 1.26 Writing Values

It is best practice to only write to AV, BV & MSV (Analogue Variables, Binary Variables, and Multistate Variables). When writing to these, it is best to write at priority level 16.

### 1.27 Typical Basic Commissioning

- Set the analogue variables “Extract Fan Min Speed”, “Supply Fan Min Speed”, “Extract Fan Max Speed” and “Supply Fan Max Speed” during commissioning.
- If flow measurements are required enable the unit using the “Enable” MSV and boost the unit using the “Fan Boost” MSV.

### 1.28 Typical Basic Operation

- Enable the unit using the MSV “Enable” object. The fan runs at min speed.
- Increase the fan speeds using the AV “Fan Speed Demand” 0-100% (0% = Min Commissioned Speed, 100%= Max Commissioned Speed).
- Adjust setpoint using the AV “Software Setpoint”.



### 1.29 Writing Directly To Outputs

- It is not recommended to write directly to outputs since the internal logic of the control will be bypassed and some features will not function. The unit may also start without an enable signal.
- However, if this is required for test purposes (or otherwise), priority level 8 must be used.
- The internal control logic writes at priority level 16 so any data written to the outputs at this level is at risk of being overwritten.
- These values must be relinquished or nulled once used, otherwise the outputs will be locked at that value, even if the value is "0".

### 1.30 Priority Array Storage

- Priority levels 8 & 16 are stored in the controller following a power cycle. All other levels are reset to null.
- Level 16 is not to be used for controller outputs since it will be overridden by the internal logic during operation.

### 1.31 Devices

A BACnet network can consist of several "device objects". Each device is given a unique "Device Instance Number". A typical example of a device is a controller or BACnet compatible LCD. EcoSmart Connect controllers are assigned a random device instance number at the factory and do not need to be changed. The instance number range is 1 - 4,194,303 (2<sup>22</sup>). EcoSmart Connect controllers use a MSTP network for communication and are assigned a default MSTP address of 4.

The MSTP address must not be confused with the Device Instance Number. Most network browsers can identify a device by the Device Instance Number or the MSTP address.

### 1.32 Objects

In BACnet, information is stored within devices as several 'virtual' objects. Some examples of these are Fresh Air Temperature, Extract Fan Speed, CO2 Target, etc. Each object has several properties but the most important are shown in the table below. The maximum number of objects in a device is 4,194,303 (2<sup>22</sup>) of each type.

Object Name	The name of the object. E.g. Setpoint
Object Instance Number	A unique number which represents the object within the device. E.g. 12544
Object Type	The type of object. E.g. Analogue Variable (AV)
Description	A short description of the object. E.g. The room setpoint
Present Value	The current value of the object. E.g. 20
Units	The units of the present value. E.g. °C

### 1.33 Object Types

A list of some typical object types is shown below.

AI	Analogue Input	An analogue object which is a physical input to a device.
AO	Analogue Output	An analogue object which is a physical output from a device.
AV	Analogue Variable	An analogue object which exists within a device.
BI	Binary Input	A true/false object which is a physical input to a device.
BO	Binary Output	A true/false object which is a physical output from a device.
BV	Binary Variable	A true/false object which exists within a device.
MSV	Multi-State Variable	This is an enumerated object which can have a number of states, each represented by a number. This is similar to a dropdown menu in windows forms. The State_Text property is an array containing the text for each value. Some browsers may not be able to read the text values so both are provided in this manual. E.g. 1=Off, 2=Low, 3=High, 4=Auto
SCH	Schedule Object	This is a special object with the ability to have a changing value depending on the time of date or day of the week.

1.34 Writing Of Values (Priority Array)

Any device on the BACnet network can write values to other device objects. To resolve conflicts, BACnet uses a 16-position priority array to work out who gets priority. Any request to change the present value is stored in the priority array at the priority level of the received request. The object then chooses the highest priority value to become the present value. Examples of priority array decision making are shown below.

Case 1		Case 2		Case 3		Case 4		Case 4	
Priority 1	null	Priority 1	null	Priority 1	null	Priority 1	null	Priority 1	null
Priority 2	null	Priority 2	null	Priority 2	null	Priority 2	null	Priority 2	null
Priority 3	null	Priority 3	null	Priority 3	null	Priority 3	null	Priority 3	null
Priority 4	null	Priority 4	null	Priority 4	null	Priority 4	null	Priority 4	null
Priority 5	null	Priority 5	null	Priority 5	null	Priority 5	null	Priority 5	null
Priority 6	null	Priority 6	null	Priority 6	null	Priority 6	null	Priority 6	null
Priority 7	null	Priority 7	null	Priority 7	null	Priority 7	null	Priority 7	null
Priority 8	null	Priority 8	null	Priority 8	null	Priority 8	null	Priority 8	null
Priority 9	null	Priority 9	null	Priority 9	7	Priority 9	7	Priority 9	null
Priority 10	null	Priority 10	null	Priority 10	null	Priority 10	null	Priority 10	null
Priority 11	null	Priority 11	null	Priority 11	null	Priority 11	null	Priority 11	null
Priority 12	null	Priority 12	null	Priority 12	null	Priority 12	null	Priority 12	null
Priority 13	null	Priority 13	null	Priority 13	null	Priority 13	null	Priority 13	null
Priority 14	null	Priority 14	null	Priority 14	null	Priority 14	null	Priority 14	null
Priority 15	null	Priority 15	null	Priority 15	null	Priority 15	null	Priority 15	null
Priority 16	null	Priority 16	5	Priority 16	5	Priority 16	0	Priority 16	0
Relinquish Default	0	Relinquish Default	0	Relinquish Default	0	Relinquish Default	0	Relinquish Default	0
Present Value	0	Present Value	5	Present Value	7	Present Value	7	Present Value	0

Priority	Application
1	Manual Life Safety
2	Automatic Life Safety
3	Available
4	Available
5	Critical Equipment Control
6	Minimum On/Off
7	Available
8	Manual Operator
9	Available
10	Available
11	Available
12	Available
13	Available
14	Available
15	Available
16	Available

1.35 Inter-Networking

Inter-networking is used to connect two BACnet networks operating on different physical mediums (e.g. MSTP & IP). This is possible because no matter the physical medium, BACnet messages are always the same. A router can be fitted to the network to translate BACnet between different physical media.

1.35.1 Example BACnet Network

- **Case 1** - The object looks down the list until it gets to the first non-null value. In this case, all priority levels are empty so the (relinquish) default value of 0 is used as the present value.
- **Case 2** - Priority 16 is now 5 so the present value becomes 5.
- **Case 3** - Priority 9 is now 7. Priority 9 overrules priority 16 so the present value becomes 7. Note that priority 16 is still calling for 5 but it is being ignored.
- **Case 4** - Priority 16 is changed to 0 but this has no effect on the present value. It is still at 7 because of priority 9.
- **Case 5** - Priority 9 is relinquished back to null. This allows priority 16 to take priority again and the present value becomes 0.

The priority array is stored inside the device itself. This means that an external device can write to a priority position and the value will stay there even if the device is disconnected.

AI and BI object types are read only and therefore do not have a priority array.

AO & BO values are typically changed by the strategy at priority level 16. Any override must occur above this level and is not recommended. Be sure to relinquish all overrides once finished to minimise confusion and undesirable operation.

AV, BV & MSV values are generally not changed by the strategy so an external command at priority level 16 is sufficient to change the value permanently.

The following table shows the standard use of the priority array.

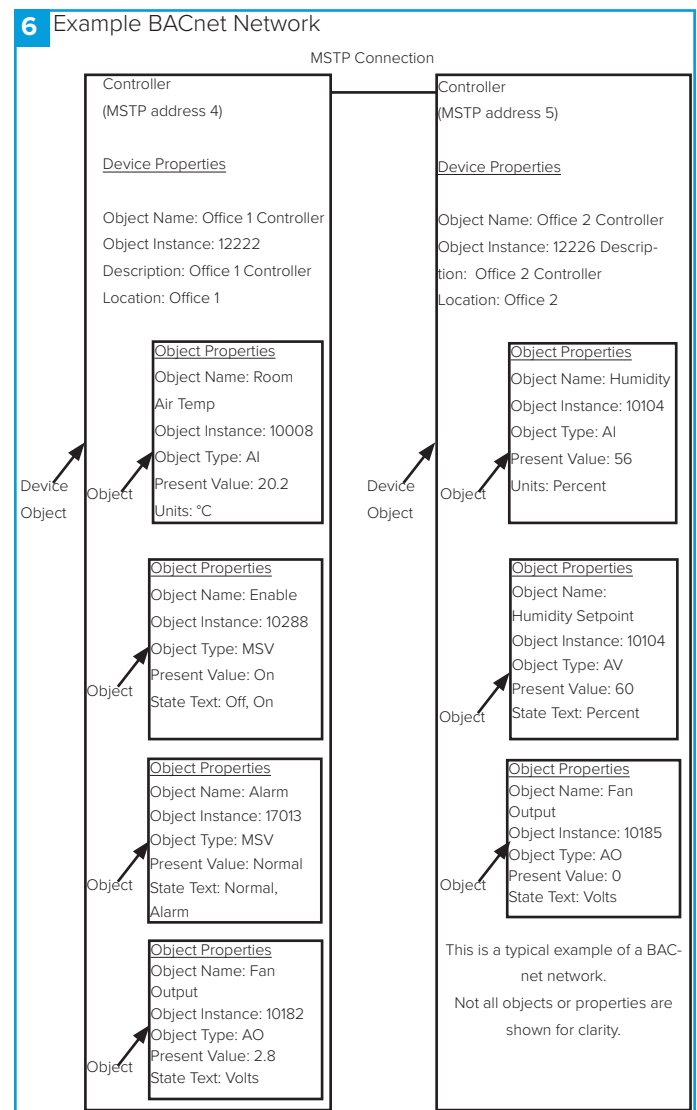

1.36 BACnet Point List

1.36.1 Table 1 - Points List (XBC/Boxer/BPS)

Basic Config

Page	Object Name	Description	Point Type	Instance Number	Default Value	Range
1	Unit Selection	Unit Type - State 0 (XBC) / State 1 (BPS) / State 2 (BOXER)	MSV	28508	XBC	0 = XBC 1 = BPS 2 = BOXER
1	Heating Type	Selection of Heating Type: State 0 (None) State 1 (LPHW) State 2 (Electric Heater) State 3 (3rd Party)	MSV	28509	None	0 = None 1 = LPHW 2 = Electric Heater 3 = 3rd Party
1	Cooling Type	Selection of Cooling Type: State 0 (None) State 1 (Chilled Water) State 2 (3rd Party) State 3 (Reverse Cycle DX)	MSV	28510	None	0 = None 1 = Chilled Water 2 = Heat Pump 3 = Reverse Cycle DX
3	Tacho Board Fitted	Tacho Board Fitted	MSV	28525	No	0 = No 1 = Yes
15	Fan Config	Fan Configuration for Boxer Units - State 0 (Supply Only) / State 1 (Extract Only) / State 2 (Both)	MSV	28616	Both	0 = Supply 1 = Extract 2 = Both
26	PAC Board Fitted	PAC Board Fitted	MSV	28689	No	0 = No 1 = Yes

Enable

Page	Object Name	Description	Point Type	Instance Number	Default Value	Range
2	Unit Enable	Enable the Unit	MSV	28511	Off	0 = Off 1 = On
3	VF Enable	Volt Free Enable (IN5)	MSV	28522	Off	0 = Normal 1 = Alarm
27	Enable Schedule Active	Enable Schedules Current State	MSV	28991	Off	0 = Off 1 = On
33	Enable Schedule	Enable Internal Schedule	SCH	1	---	---

Fan Commissioning

Page	Object Name	Description	Point Type	Instance Number	Default Value	Range
51	SF Max Demand	Supply Temperature Max Demand	AV	28621	100	0..100 %
51	SF Min Demand	Supply Temperature Min Demand	AV	28622	20	0..100 %
52	EF Max Demand	Extract Fan Maximum Demand	AV	28623	100	0..100 %
52	EF Min Demand	Extract Fan Minimum Demand	AV	28624	20	0..100 %
57	Heat Pump Fan Min	Heat Pump Minimum Fan Speed	AV	28694	40%	0..100%



Schedules

Page	Object Name	Description	Point Type	Instance Number	Default Value	Range
32	Night Cooling Schedule	Night Cooling Internal Schedule	SCH	4	---	---
32	Purge Schedule	Purge Mode Internal Schedule	SCH	3	---	---
33	Enable Schedule	Enable Internal Schedule	SCH	1	---	---
33	Alarm Reset Schedule	Reset the Alarms	SCH	2	---	---

HX Bypass Damper

Page	Object Name	Description	Point Type	Instance Number	Default Value	Range
4	Bypass Damper	Bypass damper Status (Output OUT6)	MSV	28534	Inactive	0 = Inactive 1 = Active
16	Damper Override LV	Manual Damper override - State 0 (Auto) / State 1 (HX) / State 2 (Bypass)	MSV	28620	Auto	0 = Auto 1 = HX 2 = Bypass

Fan Boost

Page	Object Name	Description	Point Type	Instance Number	Default Value	Range
16	Fan Boost	Enable Fan Boost	MSV	28629	Off	0 = Off 1 = On
52	EF Boost Speed	Extract Fan Boost Speed	AV	28630	100	0..100 %
53	SF Boost Speed	Supply Temperature Boost Speed	AV	28631	100	0..100 %

Trickle Mode

Page	Object Name	Description	Point Type	Instance Number	Default Value	Range
19	Trickle Mode	Trickle Mode Enabled	MSV	28656	Off	0 = Off 1 = On
57	Trickle Deadband	Setpoint deadband to be used while unit is in trickle	AV	28690	5	0..100 degC

Auto Run On

Page	Object Name	Description	Point Type	Instance Number	Default Value	Range
20	Fan Active	Fan Run-on Active	MSV	28661	0	0 = False 1 = True
50	Run-on	Run on time for Fan Signal	AV	28617	0	0..120 seconds

IO Dampers

Page	Object Name	Description	Point Type	Instance Number	Default Value	Range
3	IO Damper Fitted	IO Damper Fitted	MSV	28524	No	0 = No 1 = Yes
19	Re-circ Override	Recirculation Override (State 0 = Auto, State 1 = Open, State 2 = Close)	MSV	28657	Auto	0 = Auto 1 = Open 2 = Close
21	Fan to Damper Delay	IO Damper Delay Active	MSV	28663	0	0 = False 1 = True
49	IO Damper Delay	IO Damper Delay	AV	28693	60	0...120 seconds

Fan Outputs

Page	Object Name	Description	Point Type	Instance Number	Default Value	Range
2	Unit Fault Status	Fault Relay (Output OUT9)	MSV	28538	Normal	0 = Alarm 1 = Normal
4	Fan Command	Fan Enable Command (Output OUT10)	MSV	28536	Off	0 = Off 1 = On
46	Supply Fan Speed AO	Supply Fan Speed Analogue Output	AV	28530	0	0...10 V
46	Extract Fan Speed AO	Extract Fan Speed Analogue Output	AV	28531	0	0...10 V

Supply & Extract Setback

Page	Object Name	Description	Point Type	Instance Number	Default Value	Range
16	EF Setback Enable	Extract Fan Setback from Supply	MSV	28625	Off	0 = Off 1 = On
16	SF Setback Enable	Supply Fan Setback from Extract	MSV	28627	Off	0 = Off 1 = On
52	EF Setback Speed	Set the speed for the Setback	AV	28626	30	0...100 %
52	SF Setback Speed	Set the percentage setback for the Supply Fan Setback	AV	28628	30	0...100 %

### Temperature Control

Page	Object Name	Description	Point Type	Instance Number	Default Value	Range
13	Temp Sensor Operation	Temperature Sensor Operation - State 0 (RM Average) / State 1 (Return Air Only) / State 2 (RM & Return Air Average)	MSV	28608	RM Average	0 = RM Average 1 = Return Air Only 2 = RM & Return Air
14	Setpoint Operation	Setpoint Input Operation - State 0 (Last Changed) / State 1 (Software Only) / State 2 (Last Changed with timeout)	MSV	28612	Software Only	0 = Last Changed 1 = Software Only 2 = Last Changed with Timeout
15	Control Type	Temperature Control Selection - State 0 (Supply Temp Control / State 1 (Return Temp Control)	MSV	28615	Supply Temp	0 = Supply Temp 1 = Room Temp
20	Reverse Cycle Backup Heating	Enables OUT3 heating output if Backup heating is present for Reverse cycle systems	MSV	28658	Off	0 = Off 1 = On
55	SA-T Low Limit	Supply Low Temperature Low Limit	AV	28640	8	5...15 deg C
56	Max Supply Temp	Return Temp Control Maximum Supply Temperature	AV	28651	35	30...40 deg C
56	Min Supply Temp	Return Temp Control Minimum Supply Temperature	AV	28652	12	10...20 deg C
56	Software Setpoint	Network Temperature Setpoint	AV	28654	22	12...28 deg C
57	Back Heater Temp Differential	Backup heater setpoint differential (added to setpoint)	AV	28692	-4	-20...20 deg C

### Temperature Sensors

Page	Object Name	Description	Point Type	Instance Number	Default Value	Range
41	Supply Air Temperature	Supply Air temperature	AV	28501	Current	-20...100 deg C
42	Fresh Air Intake	Fresh air Temperature	AV	28502	Current	-20...100 deg C
42	Return Air Temperature	Return Air Temperature	AV	28503	Current	-20...100 deg C
42	Room Temperature	Room Temperature	AV	28504	Current	-20...100 deg C
57	Back Heater Air Off Temp	Backup Heater Air Off Temperature (BPS Heat Pump only IN18)	AV	28695	Current	0...100 deg C

### Heat Boost

Page	Object Name	Description	Point Type	Instance Number	Default Value	Range
17	Heat Boost	Heat Boost Enable	MSV	28635	Off	0 = Off 1 = On
54	Heat Boost Setpoint	Heat Boost Setpoint	AV	28636	35°C	0...50°C

### Heating Outputs

Page	Object Name	Description	Point Type	Instance Number	Default Value	Range
4	Heat Demand	Heat / Recirc Demand (Output OUT8)	MSV	28535	Off	0 = Off 1 = On
46	Heating Output	Heating Output	AV	28532	0	0...100 %

Cooling Outputs

Page	Object Name	Description	Point Type	Instance Number	Default Value	Range
2	Cooling Demand	Cooling Demand Status	MSV	28537	Off	0 = Off 1 = On
18	Cooling Output Type	OUT4 Mode Selection - State 0 (Cooling Demand) / State 1 (ESClassic BMS)	MSV	28645	Cooling Demand	0 = Cooling Demand 1 = ESClassic BMS
47	Cooling Output	Cooling Output	AV	28533	0	0..100 %

Analog Inputs

Page	Object Name	Description	Point Type	Instance Number	Default Value	Range
10	IN16 Function	IN16 Function Input - State 0 (None) / State 1 (N/A) / State 2 (N/A) / State 3 (0-10v CO2 Sensor) / State 4 (0-10v Temp Sensor) / State 5 (0-10v Hum Sensor) / State 6 (0-10v Press Sensor)	MSV	28595	None	0 = None 1 = N/A 2 = N/A 3 = 0 to 10V CO2 Sensor 4 = 0 to 10V Temp Sensor 5 = 0 to 10V Hum Sensor 6 = 0 to 10V Press Sensor
10	IN17 Function	IN17 Function Input - State 0 (None) / State 1 (FS Control) / State 2 (0-10v BMS) / State 3 (0-10v CO2 Sensor) / State 4 (0-10v Temp Sensor) / State 5 (0-10v Hum Sensor) / State 6 (0-10v Press Sensor)	MSV	28596	None	0 = None 1 = Fan Speed Control 2 = 0 to 10V BMS 3 = 0 to 10V CO2 Sensor 4 = 0 to 10V Temp Sensor 5 = 0 to 10V Hum Sensor 6 = 0 to 10V Press Sensor
11	0-10v Temp Range for IN16 & IN17	0-10v Temp Range Select for IN4 & IN5	MSV	28597	0 to 50 degC	0 = 0 to 50 degC 1 = 0 to 40 degC 2 = 0 to 100 degC 3 = 0 to 80 degC 4 = 0 to 90 degC
11	0-10v Press Range for IN16 & IN17	0-10v Pressure Range Select for IN16 & IN17 - State 0 (0-25) / State 1 (0-50) / State 2 (0-100) / State 3 (0-300) / State 4 (0-500) / State 5 (0-1000) / State 6 (0-1600) / State 7 (0-2500) / State 8 (0-3000)	MSV	28598	0 to 1000 Pa	0 = 0 to 25 Pa 1 = 0 to 50 Pa 2 = 0 to 100 Pa 3 = 0 to 300 Pa 4 = 0 to 500 Pa 5 = 0 to 1000 Pa 6 = 0 to 1600 Pa 7 = 0 to 2500 Pa 8 = 0 to 3000 Pa
11	0-10v CO2 Range for IN16 & IN17	0-10v CO2 Range Select for IN16 & IN17 - State 0 (0-2000) / State 1 (0-4000) / State 2 (0-5000) / State 3 (0-10000) / State 4 (0-20000)	MSV	28599	0 to 2,000	0 = 0 to 2000 1 = 0 to 4,000 2 = 0 to 5,000 3 = 0 to 10,000 4 = 0 to 20,000
11	IN16 is Temperature	IN16 is Temperature	MSV	28600	FALSE	0 = False 1 = True
12	IN16 is Humidity	IN16 is Humidity	MSV	28601	FALSE	0 = False 1 = True
12	IN16 is CO2	IN16 is CO2	MSV	28602	FALSE	0 = False 1 = True
12	IN16 is Pressure	IN16 is Pressure	MSV	28603	FALSE	0 = False 1 = True
12	IN17 is Temperature	IN17 is Temperature	MSV	28604	FALSE	0 = False 1 = True
13	IN17 is Humidity	IN17 is Humidity	MSV	28605	FALSE	0 = False 1 = True

Page	Object Name	Description	Point Type	Instance Number	Default Value	Range
13	IN17 is CO2	IN17 is CO2	MSV	28606	FALSE	0 = False 1 = True
13	IN17 is Pressure	IN17 is Pressure	MSV	28607	FALSE	0 = False 1 = True

### Configurable Inputs

Page	Object Name	Description	Point Type	Instance Number	Default Value	Range
3	VF2 Input	Volt Free Input (IN6)	MSV	28523	Off	0 = Off 1 = On
19	VF2 Mode	Volt Free 2 Mode - State 0 (None) / State 1 (Fan Boost) / State 2 (Heating Boost) / State 3 (Extract Setback)	MSV	28653	Fan Boost	0 = None 1 = Fan Boost 2 = Heating Boost 3 = Extract Setback

### Selected Process Variables

Page	Object Name	Description	Point Type	Instance Number	Default Value	Range
45	Effective Setpoint	Current Effective Setpoint	AV	28526	22	0..100 deg C
45	Eff CO2	Current Effective CO2 of the Room	AV	28527	0.1	0..100 ppm
45	Effective Zone Humidity	Current Effective Humidity of the Room	AV	28528	0.1	0..100 %RH
46	Effective Pressure	Current Effective Room Pressure	AV	28529	0	0..100 Pa

### Frost Protection

Page	Object Name	Description	Point Type	Instance Number	Default Value	Range
53	Frost Protection Temperature	Minimum Temperature for Frost protection to start	AV	28634	5	5..15 deg C
54	Frost Protection Fan Off	Frost protection fan run-on timer	AV	28691	300	0..600 seconds

### Hibernate

Page	Object Name	Description	Point Type	Instance Number	Default Value	Range
17	Hibernate Mode	Hibernate Mode	MSV	28637	Off	0 = Off 1 = On

### Night Cool Mode

Page	Object Name	Description	Point Type	Instance Number	Default Value	Range
18	NFC Enable	Night Free Cooling Enable	MSV	28642	Off	0 = Off 1 = On
18	NFC Schedule Active	Night Free Cooling Schedule Input	MSV	28643	Off	0 = Off 1 = On
32	Night Cooling Schedule	Night Cooling Internal Schedule	SCH	4	---	---
54	NFC Fan Speed	Night Free Cooling Fan Speed	AV	28641	60	0..100%
55	NFC Min Temp	Night Free Cooling Minimum Temperature	AV	28644	12	0..100 deg C



Purge Mode

Page	Object Name	Description	Point Type	Instance Number	Default Value	Range
18	Purge Enable	Purge Enable	MSV	28647	Off	0 = Off 1 = On
27	Purge Schedule Active	Set the purge schedule	MSV	28993	Off	0 = Off 1 = On
32	Purge Schedule	Purge Mode Internal Schedule	SCH	3	---	---
55	Purge Fan Speed	Purge Fan Speed	AV	28649	60	0..100%
56	Purge Low SA-T Setpoint	Purge Maximum Temperature	AV	28650	12	5..15 deg C

Room Modules

Page	Object Name	Description	Point Type	Instance Number	Default Value	Range
2	RM199 Status	Status of Network Sensor 1	MSV	28539	0	0 = False 1 = True
4	RM199 Fan Speed Request	RM199 Fan Speed	MSV	28544	Auto	0 = Auto 1 = Off 2 = Low 3 = Medium 4 = High
5	RM199 Occupancy	RM199 Occupancy	MSV	28545	Occupied	0 = Occupied 1 = Unoccupied
5	RM200 Status	Status of Network Sensor 2	MSV	28546	0	0 = False 1 = True
5	RM200 Fan Speed Request	RM200 Fan Speed	MSV	28551	Auto	0 = Auto 1 = Off 2 = Low 3 = Medium 4 = High
5	RM200 Occupancy	RM200 Occupancy	MSV	28552	Occupied	0 = Occupied 1 = Unoccupied
6	RM201 Status	Status of Network Sensor 3	MSV	28553	0	0 = False 1 = True
6	RM201 Fan Speed Request	RM201 Fan Speed	MSV	28558	Auto	0 = Auto 1 = Off 2 = Low 3 = Medium 4 = High
6	RM201 Occupancy	RM201 Occupancy	MSV	28559	Occupied	0 = Occupied 1 = Unoccupied
6	RM202 Status	Status of Network Sensor 4	MSV	28560	0	0 = False 1 = True
7	RM202 Fan Speed Request	Fan speed override status of RM202	MSV	28565	Auto	0 = Auto 1 = Off 2 = Low 3 = Medium 4 = High
7	RM202 Occupancy	RM202 Occupancy	MSV	28566	Occupied	0 = Occupied 1 = Unoccupied
7	RM203 Status	Status of Network Sensor 5	MSV	28567	0	0 = False 1 = True

Page	Object Name	Description	Point Type	Instance Number	Default Value	Range
7	RM203 Fan Speed Request	RM203 Fan Speed	MSV	28572	Auto	0 = Auto 1 = Off 2 = Low 3 = Medium 4 = High
8	RM203 Occupancy	RM203 Occupancy	MSV	28573	Occupied	0 = Occupied 1 = Unoccupied
8	RM204 Status	Status of Network Sensor 6	MSV	28574	0	0 = False 1 = True
8	RM204 Fan Speed Request	Fan speed override status of RM204	MSV	28579	Auto	0 = Auto 1 = Off 2 = Low 3 = Medium 4 = High
8	RM204 Occupancy	RM204 Occupancy	MSV	28580	Occupied	0 = Occupied 1 = Unoccupied
9	RM205 Status	Status of Network Sensor 7	MSV	28581	0	0 = False 1 = True
9	RM205 Fan Speed Request	RM205 Fan Speed	MSV	28586	Auto	0 = Auto 1 = Off 2 = Low 3 = Medium 4 = High
9	RM205 Occupancy	RM205 Occupancy	MSV	28587	Occupied	0 = Occupied 1 = Unoccupied
9	RM206 Status	Status of Network Sensor 8	MSV	28588	0	0 = False 1 = True
10	RM206 Fan Speed Request	RM206 Fan Speed	MSV	28593	Auto	0 = Auto 1 = Off 2 = Low 3 = Medium 4 = High
10	RM206 Occupancy	RM205 Occupancy	MSV	28594	Occupied	0 = Occupied 1 = Unoccupied
37	RM206 Sensor Setpoint	RM206 Setpoint	AV	28592	---	12...28 deg C
37	RM205 Humidity AI	RM205 Humidity Sensor Analogue Input	AV	28583	---	0...100 %RH
37	RM205 Temp AI	RM205 Temperature Sensor Analogue Input	AV	28582	---	0...40 deg C
37	RM205 CO2 AI	RM205 CO2 Sensor Analogue Input	AV	28584	---	0...2000 ppm
38	RM204 Sensor Setpoint	RM204 Setpoint	AV	28578	---	12...28 deg C
38	RM204 CO2 AI	RM204 CO2 Sensor Analogue Input	AV	28577	---	0...2000 ppm
38	RM204 Humidity AI	RM204 Humidity Sensor Analogue Input	AV	28576	---	0...100 %RH
38	RM204 Temp AI	RM204 Temperature Sensor Analogue Input	AV	28575	---	0...40 deg C
39	RM203 Sensor Setpoint	RM203 Setpoint	AV	28571	---	12...28 deg C
39	RM203 CO2 AI	RM203 CO2 Sensor Analogue Input	AV	28570	---	0...2000 ppm
39	RM203 Humidity AI	RM203 Humidity Sensor Analogue Input	AV	28569	---	0...100 %RH
39	RM203 Temp AI	RM203 Temperature Sensor Analogue Input	AV	28568	---	0...40 deg C

Page	Object Name	Description	Point Type	Instance Number	Default Value	Range
39	RM202 Sensor Setpoint	RM202 Setpoint	AV	28564	---	12...28 deg C
40	RM202 Humidity AI	RM202 Humidity Sensor Analogue Input	AV	28562	---	0...100 %RH
40	RM202 Temp AI	RM202 Temperature Sensor Analogue Input	AV	28561	---	0...40 deg C
40	RM201 Sensor Setpoint	RM201 Setpoint	AV	28557	---	12...28 deg C
40	RM202 CO2 AI	RM202 CO2 Sensor Analogue Input	AV	28563	---	0...2000 ppm
41	RM201 CO2 AI	RM201 CO2 Sensor Analogue Input	AV	28556	---	0...2000 ppm
41	RM201 Humidity AI	RM201 Humidity Sensor Analogue Input	AV	28555	---	0...100 %RH
41	RM201 Temp AI	RM201 Temperature Sensor Analogue Input	AV	28554	---	0...40 deg C
47	RM199 Temp AI	RM199 Temperature Sensor Analogue Input	AV	28540	---	0...40 deg C
47	RM199 Humidity AI	RM199 Humidity Sensor Analogue Input	AV	28541	---	0...100 %RH
47	RM199 CO2 AI	RM199 CO2 Sensor Analogue Input	AV	28542	---	0...2000 ppm
48	RM200 CO2 AI	RM200 CO2 Sensor Analogue Input	AV	28549	---	0...2000 ppm
48	RM200 Temp AI	RM200 Temperature Sensor Analogue Input	AV	28547	---	0...40 deg C
48	RM200 Humidity AI	RM200 Humidity Sensor Analogue Input	AV	28548	---	0...100 %RH
48	RM199 Sensor Setpoint	RM199 Setpoint	AV	28543	---	12...28 deg C
48	RM200 Temp AI	RM200 Temperature Sensor Analogue Input	AV	28547	---	0...40 dec C
48	RM200 Humidity AI	RM200 Humidity Sensor Analogue Input	AV	28548	---	0...100 %RH
49	RM200 Sensor Setpoint	RM200 Setpoint	AV	28550	---	12...28 deg C
49	RM205 Sensor Setpoint	RM205 Setpoint	AV	28585	---	12...28 deg C
50	RM206 Temp AI	RM206 Temperature Sensor Analogue Input	AV	28589	---	0...40 deg C
50	RM206 Humidity AI	RM206 Humidity Sensor Analogue Input	AV	28590	---	0...100 %RH
50	RM206 CO2 AI	RM206 CO2 Sensor Analogue Input	AV	28591	---	0...2000 ppm

### Configurable Outputs

Page	Object Name	Description	Point Type	Instance Number	Default Value	Range
15	BMS Temperature Output	BMS Configuration Output	MSV	28613	Auto	0 = Auto 1 = None 2 = Heating 3 = Cooling
42	IN16 CO2 Sensor	IN16 CO2	MSV	28512	0ppm	0...2000 ppm
43	IN16 Temperature Sensor	IN16 Temperature	MSV	28513	Current	0...50 deg C
43	IN16 Humidity Sensor	IN16 Relative Humidity	AV	28514	0%	0...100% RH

Page	Object Name	Description	Point Type	Instance Number	Default Value	Range
43	IN16 Pressure Sensor	IN16 Pressure	AV	28515	0 Pa	0 to 2000 Pa
43	IN17 CO2 Sensor	IN17 CO2	AV	28516	0 ppm	0 to 2,000 ppm
44	IN17 Temperature Sensor	IN17 Temperature	AV	28517	0°C	0 to 50 degC
44	IN17 Humidity Sensor	IN17 Relative Humidity	AV	28518	0%	0...100 %RH
44	IN17 Pressure Sensor	IN17 Pressure	AV	28519	0 Pa	0 to 2000 Pa
44	IN17 Fan Speed Control	IN17 Fan Speed	AV	28520	0%	0...100%
45	IN17 BMS 0-10v	IN17 BMS 0-10v	AV	28521	0%	0...100%

### Fan Demand Inputs

Page	Object Name	Description	Point Type	Instance Number	Default Value	Range
14	Humidity Sensor Operation	Humidity Sensor Operation - State 0 (Average) / State 1 (Minimum) / State 2 (Ignore)	MSV	28609	Average RH%	0 = Average RH% 1 = Minimum RH% 2 = Ignore RH%
14	CO2 Sensor Operation	CO2 Sensor Operation - State 0 (Average) / State 1 (Minimum) / State 2 (Ignore)	MSV	28610	Average CO2	0 = Average CO2 1 = Minimum CO2 2 = Ignore CO2
14	Pressure Sensor Operation	Pressure Sensor Operation - State 0 (Average) / State 1 (Minimum) / State 2 (Ignore)	MSV	28611	Average	0 = Average 1 = Maximum 2 = Ignore
15	Ignore PIR Occ Sensors	Occupancy Sensor Enabled	MSV	28614	No	0 = No 1 = Yes
20	Occupancy Status	Occupancy mode wo Runon	MSV	28662	Occupied	0 = Occupied 1 = Unoccupied 2 = Bypass 3 = Standby
51	BMS 0-10v Input	0-10V Network Fan speed demand, along with OUT4 output in "ESClassic BMS" mode	AV	28618	0	0...10 V
51	CO2 Setpoint	In-Room CO2 Setpoint	AV	28619	650	0...2000 ppm
53	Fan Speed Command	0-10V Network Fan Speed Demand	AV	28632	0	0...100 %
54	Humidity Setpoint	In-room humidity Setpoint	AV	28638	50	40...60 %RH
55	Pressure Setpoint	Static Pressure Setpoint	AV	28646	400	0...1000 Pa

### Fire Alarm

Page	Object Name	Description	Point Type	Instance Number	Default Value	Range
17	Fire Alarm	Fire Alarm Network Input	MSV	28633	Normal	0 = Normal 1 = Alarm
24	Fire Alarm State	Fire Alarm	MSV	28675	Normal	0 = Normal 1 = Alarm

Alarms

Page	Object Name	Description	Point Type	Instance Number	Default Value	Range
17	Low Temp Alarm Action	Low Supply Temp Action - State 0 (Alarm Only) / State 1 (Alarm & Stop Fans)	MSV	28639	Alarm Only	0 = Alarm Only 1 = Alarm and Stop fans
20	Reset Alarm	Reset the Alarms	MSV	28660	Off	0 = Off 1 = Reset
21	Active Critical Alarms	Critical Alarm	MSV	28664	Normal	0 = Normal 1 = Alarm
21	Maintenance Alarm	Maintenance Alarm	MSV	28665	Normal	0 = Normal 1 = Alarm
21	Thermal Wheel Alarm	Thermal Wheel Alarm	MSV	28666	Normal	0 = Normal 1 = Alarm
22	Supply Filter Alarm	Supply Filter Alarm	MSV	28668	Normal	0 = Alarm 1 = Normal
22	Return Filter Alarm	Return Filter Alarm	MSV	28669	Normal	0 = Alarm 1 = Normal
22	Tacho Alarm	XBC Tacho Board Alarm - Fan Fault Alarm	MSV	28670	Normal	0 = Normal 1 = Alarm
22	Supply Fan Alarms	Supply Fan Alarm	MSV	28671	Normal	0 = Alarm 1 = Normal
23	Return Fan Alarms	Return Fan Alarm	MSV	28672	Normal	0 = Alarm 1 = Normal
23	Condensate Alarm	Condensate Alarm	MSV	28667	Normal	0 = Alarm 1 = Normal
23	Heat Pump Alarm	Heat Pump Alarm	MSV	28673	Normal	0 = Alarm 1 = Normal
23	IO Damper Alarm	IO Damper Alarm	MSV	28674	Normal	0 = Normal 1 = Alarm
24	Frost Alarm	Frost Alarm	MSV	28676	Normal	0 = Normal 1 = Alarm
24	PAC Board Alarm	PAC Board Alarm (BPS, Reverse Cycle DX Only)	MSV	28677	Normal	0 = Normal 1 = Alarm
24	Sensor Alarm	Temperature Sensor Alarm	MSV	28677	Normal	0 = Normal 1 = Alarm
25	Low SA-T Alarm	Low Supply Air Temperature Alarm	MSV	28678	Normal	0 = Normal 1 = Alarm
27	Alarm Reset Schedule Active	Schedule when to reset any alarms	MSV	28992	Off	0 = Off 1 = Reset
33	Alarm Reset Schedule	Reset the Alarms	SCH	2	---	---



Trends

Page	Object Name	Description	Point Type	Instance Number	Default Value	Range
35	Room Temperature Trend	Used for Trending the Room Temperature	TND	1	---	---
35	Room CO2 Trend	Used for Trending the Room CO2	TND	2	---	---
35	Room Humidity Trend	Trend of the Room Humidity Input	TND	3	---	---
36	Setpoint Trend	Used for Trending the Temperature Setpoint	TND	4	---	---
36	Supply Air Temperature Trend	Used for Trending the Supply Air Temperature	TND	5	---	---
36	Return Air Temperature Trend	Used for Trending the Extract Air Temperature	TND	6	---	---
36	Fresh Air Intake Trend	Trend of the Intake Air Temperature of the unit	TND	7	---	---

Device

Page	Object Name	Description	Point Type	Instance Number	Default Value	Range
1	Nuaire Connect	The devices name	DEV	---	---	---
19	PID Tuning Reset	Tuning Reset for PID Loops	MSV	28655	FALSE	0 = False 1 = True
25	Wiring Verification	Internal Factory Testing - Full Functionality	MSV	28680	Off	0 = Off 1 = On
25	Test Mode(Fan)	Internal Factory Testing - Fan Only (Resets on Power Cycle)	MSV	28681	Off	0 = Off 1 = On
25	Test Mode(Heater)	Internal Factory Testing - Heater and Fan (Resets on Power Cycle)	MSV	28682	Off	0 = Off 1 = On
26	Test Mode(Overheat)	Internal Factory Testing - Heater Only (Resets on Power Cycle)	MSV	28683	Off	0 = Off 1 = On
26	Test Mode (DX Heat Only-BPS)	Internal Factory Testing - Cooling Only (Resets on Power Cycle)	MSV	28684	Off	0 = Off 1 = On
26	Test Mode(Cooling BPS)	Internal Factory Testing - Cooling and Fan (Resets on Power Cycle)	MSV	28685	Off	0 = Off 1 = On
27	Baud Rate	Communication Speed	MSV	28507	38400	0 = Auto 1 = 1200 2 = 9600 3 = 19200 4 = 38400 5 = 76800
28	SW-VAC3000-1C	Software Version Number	MSV	28679	Off	0 = Off 1 = On
28	Default Units	Default Measurement Units	MSV	28686	IP	0 = IP 1 = SI
58	Pin Code	Pin Code for Inbuilt LCD	AV	28687	0	0...9999
58	Device OID	Device Instance Number	AV	28505	Unique	0...4194302
58	Address	Device MS/TP Address	AV	28506	4	4...127

## 2.0 FC BUS DEVICES

### 2.1 Networking Connection Example

#### 7 Networking Connection Example

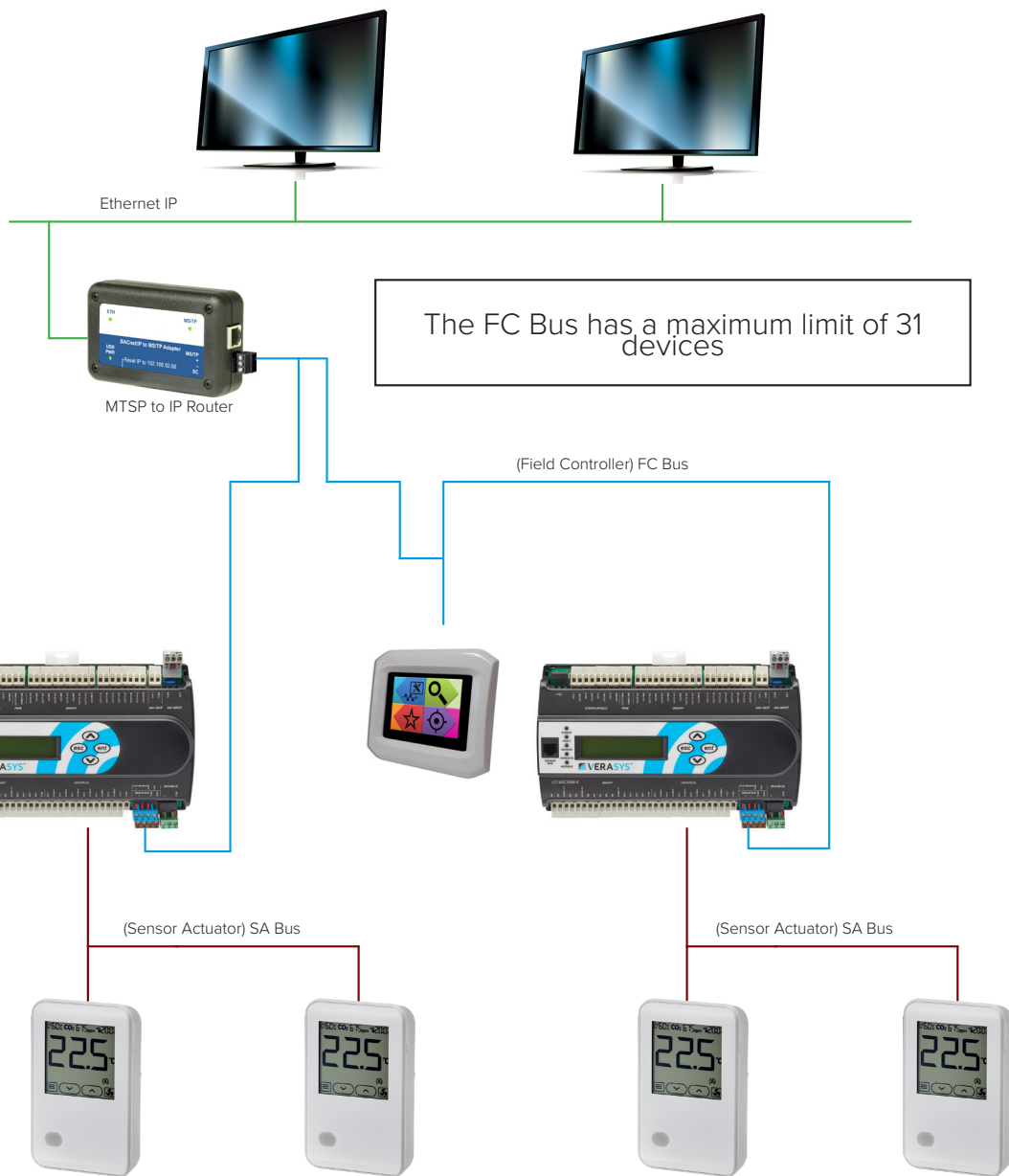

For best results, use a linear network and switch on the EOL resistors at each end of the FC bus. The EOL switch is located under the VAC controller's front cover.

## 2.2 Verasys Controller

A Verasys controller is used to control the unit. The controller can connect to the FC bus via the 4 pin FC connection.

### 8 Verasys Controller

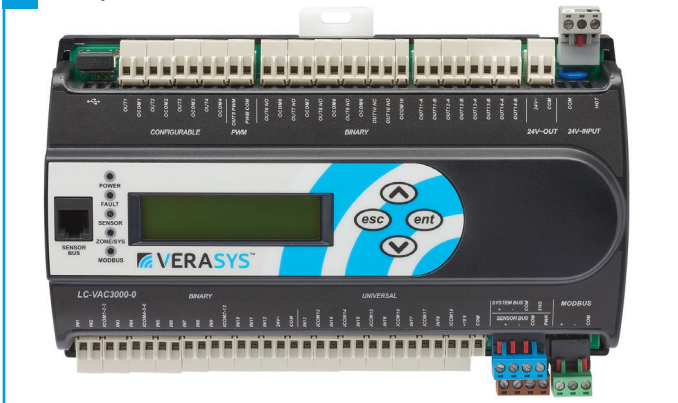

#### 2.2.1 MAC Address

The MAC address of the Verasys controller is adjustable between 4-127. When multiple controllers are connected on the same FC bus, each controller's MAC address must be unique.

This can be set via the ESCO-LCD, Inbuilt LCD or via BACnet using "Address" AV:28506 or Page 57 of the ESCO-LCD. Note: During change the device will lose its connection temporarily and will need to be re-discovered by any BACnet Device.

To set the Address via the inbuilt LCD:

Press **ent** Controller **ent** Network **ent** Address **ent**.  
The screen will flash while editing. Use the **↑** / **↓** arrows to set a new address. Press **esc** multiple times to return to the Operational screen.

#### 2.2.2 BACnet Instance Number

The BACnet instance number of the Verasys controller is factory-set to a random unique value from 0-4,194,304. This ensures that every controller will have a unique BACnet instance number on any possible network.

#### 2.2.3 End Of Line (EOL) Resistor

When a Verasys controller is used as a terminator at the end of a FC bus line, the EOL resistor dip switch can be switched on for best performance.

The resistor switch is located beneath the front cover of the controller, lift the front cover by unclipping it. Take care not to damage the ribbon cable for the buttons. If it becomes disconnected, reconnect it under the top of the PCB for the LCD.

#### 2.2.4 Fault Light Status

- **Double Blink** - Alarms Present & #1 Emergency Alarm or #1 General Alarm on LCD
- **Continuous Blink** - Startup in progress
- **Off Steady** - No Faults & Operational displayed on LCD
- **On Steady** - No Software & Clean displayed on LCD

## 2.3 BACnet IP To MS/TP Router (ESCO-IPN)

The BACnet IP to MS/TP Router exchanges information between networks and allows the controller to communicate on an IP network. One router is required for each MS/TP network.

### 9 ESCO-IPN



The BACnet router has a USB 2.0, Type B receptacle which is only used to obtain power from a computer or USB adapter. A mains adapter and cable is supplied. The router connects to the FC bus via screwed terminals.

Address Type	Default Address
IP Address	192.168.92.68
Subnet Mask	255.255.255.0 (/24)

A reset switch is available inside a small hole located on the side of the case. If you press the reset switch with a paper clip (or similar device) for at least 1 second, the switch resets to the default values of the IP address, gateway address, and netmask. After you use the reset switch, you need to reboot the router. The BACnet/IP to MS/TP Router contains a Web server. You can access the Web server from any Internet-compatible computer on the local network. To configure the router, you need a computer with an Ethernet connection, router, and standard Web browser.

#### 2.4 Interconnection

The FC bus connects via the following MSTP cabling:

- ESCO-MSTPC30M** - Ecosmart Connect MSTP cable reel 30m
- ESCO-MSTPC150M** - Ecosmart Connect MSTP cable reel 150m

Suggested Wiring Colouring:

<b>White</b>	+
<b>Green</b>	-
<b>Black</b>	COM
<b>Red</b>	Unused

On the SA Bus, the + and - wire are one twisted pair, and the COM and SA PWR are the second twisted pair of wires. These cannot be used with RJ12 connections and must be stripped and connected using screwed terminals. The shield must be earthed at the control panel end only and be made continuous along the bus length. Room Modules must not be fitted more than 150metres (cable length) from the controller.

#### 2.5 Touch Screen (ESCO-LCD(B)) Field Advanced Display (FAD)

The ESCO-LCD(B) is a user-friendly operator interface featuring BACnet® communication and a colourful, graphic display with touch-screen interface. It is powered by 12-24VAC / VDC and connected via the FC bus.

- ESCO-LCD** - Ecosmart Connect LCD Screen (White Surround)
- ESCO-LCDB** - Ecosmart Connect LCD Screen (Black Surround)

### 10 ESCO-LCD



2.5.1 ESCO-LCD(B) Navigation

11 ESCO-LCD(B) Navigation

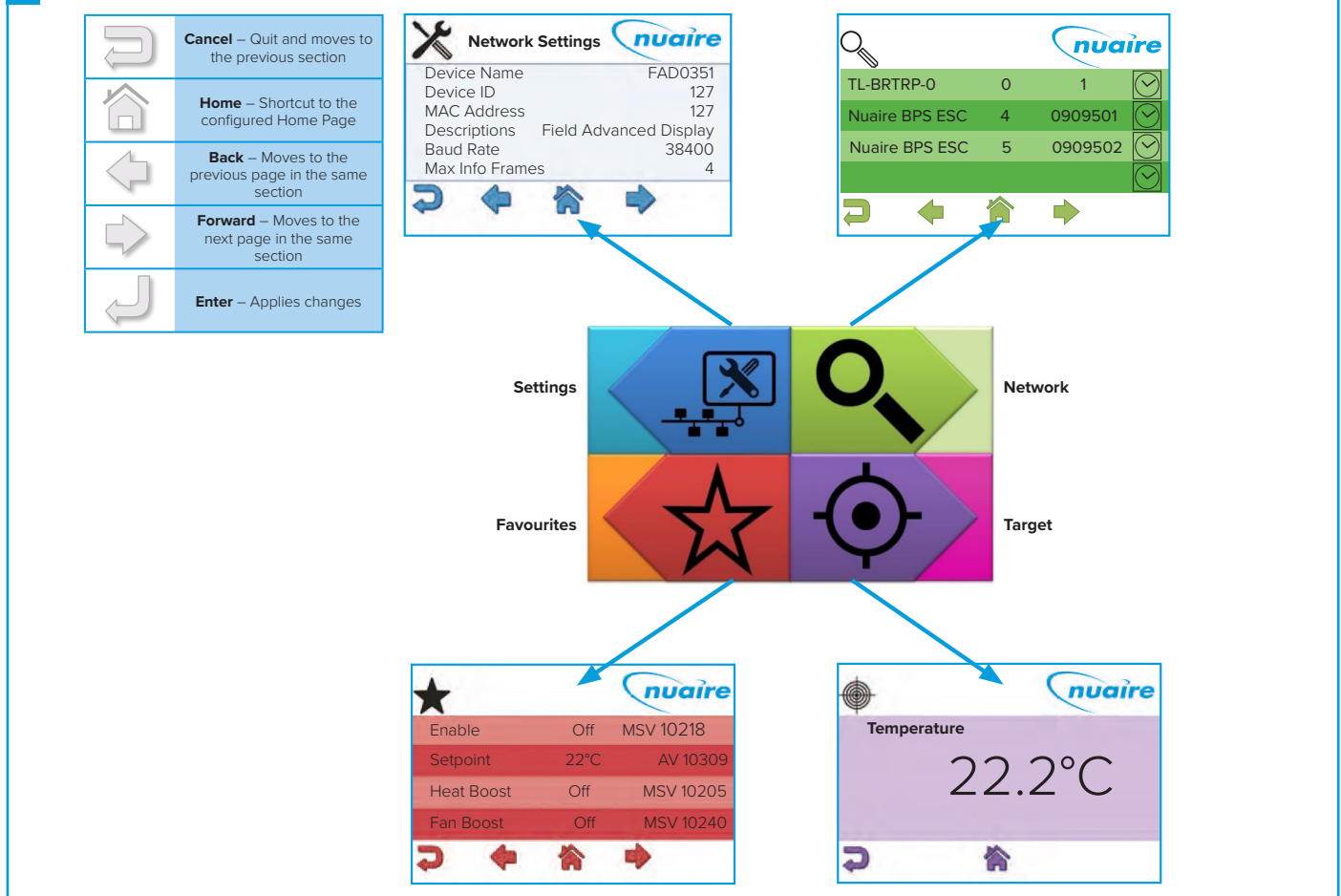

2.5.2 Writing of Values

The ESCO-LCD(B) can browse all devices and objects on the network. By default, it writes variables (BV, AV, MSV) at level 16 and outputs (BO, AO) at level 8. No BACnet device can write inputs (BI, AI). It is highly recommended that the write levels are left at the default settings of 16 for Adjust Priority and 8 for Override Priority.

The ESCO-LCD(B) will only display the present value of the object. If required, the complete priority arrays can be viewed by connecting to the network with a computer via a router and using any BACnet browser software to browse the network.

**Object Types:**

AI and BI object types are read only. An error will be displayed if an attempt is made to change these object types.

AO & BO values are changed by the strategy at priority level 16. By default, the ESCO-LCD(B) will override these values at priority level 8. Overriding these values is not recommended and may cause undesirable operation. Be sure to relinquish all overrides once finished to minimise confusion.

AV, BV & MSV values are generally not altered by the strategy. By default, the ESCO-LCD(B) will change this value at priority level 16. This is sufficient to change the value permanently.

**Relinquishing:**

The ESCO-LCD(B) allows the relinquishing of values by selected an empty value for analogue values or the '---' value for discrete values. Setting an analogue value to "0" does not relinquish the command. The relinquish command will only apply to the priority level set in the settings.

2.6 Quick Setup

The following section explains how to quickly set-up the FAD with a target object and some favourites.

2.6.1 Selecting Target Object

Target objects allow the user to view a "target" device and object within the entire network.

**Selecting A Target Object:**

- Navigate to the settings page.
- Select the right arrow four times to reach the Select Target Device screen.
- Enter the physical MAC address of the controller (Device names or BACnetIDs can also be used but MAC addresses are shorter).
- Select the right arrow once.
- Enter the object type of the required object (e.g. AI, AO, MSV).
- Enter the BACnet ID of the object (0-4194304).

12 Selecting Target Object



13 Entering Object Information

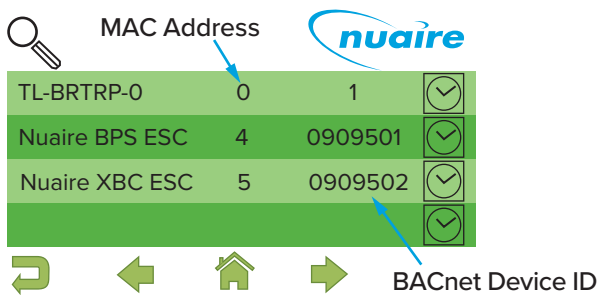
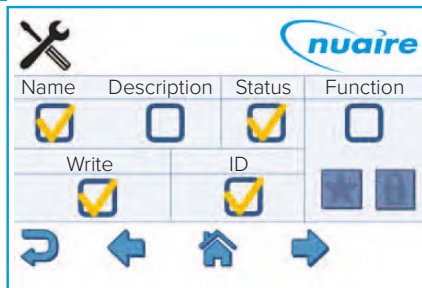

Network Page	Description	Object Type	Object ID
25	Room Temperature	AV	28504
27	Effective CO2	AV	28528
27	Effective Humidity	AV	28529
26	Effective Setpoint	AV	28527
2	Unit Enable	MSV	28512
23	Enable Schedule	SCH	
11	Fan Boost	MSV	28635
14	Heat Boost	MSV	28641
25	Fresh Air intake	AV	28501
35	Network Setpoint	AV	28669

2.6.2 Setting Default Home Page

Setting Target Object Page As Default Home Page:

- Navigate to the settings page.
- Select the right arrow twice to reach the display settings screen.
- Select Home Page.
- Select Target.
- Select the enter icon.
- Select the home icon.

The BACnet type & ID will be displayed on the target page if 'ID' is selected on the 'View Config' settings screen.

**If the target page is selected as the home page and a security password is set the home page will be locked. The only way to exit the target screen in this case is to press the Nuaire logo to the top right of the screen for 5 seconds.**

14 Setting Default Homepage



2.6.3 Setting Favourites

The "Favourite" screen displays a list of favourite objects.

To add or remove favourites:

- Navigate to the settings page.
- Select the right arrow six times to reach the View Config screen.
- Select the function tick box and favourite star.
- Select the home icon.
- Navigate to the network page.
- Select the appropriate controller.
- Navigate to the required object. See "Exposed BACnet Object List" for a full list (Pressing for 3 seconds on an object will display the full name).
- Select the star to turn it black.
- Navigate and select any other required favourites.
- When finished, navigate back to the View Config screen in the settings section and remove the function tick.

**Favourites can be removed by browsing the favourites page, selecting an object and then selecting the trash can.**

**Favourites can be re-ordered by uploading the favourite settings to a USB memory stick and changing the order of the items in the favourites.csv file. This file can then be downloaded back to the LCD.**



15 Setting Favourites

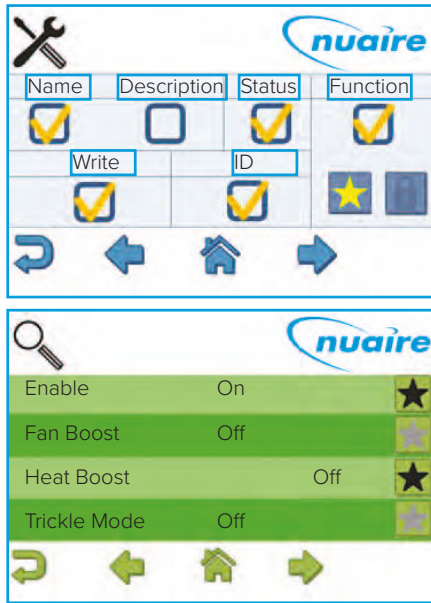

2.7.4 Allow Writing Of Basic User Values

- Navigate to the settings page.
- Select the right arrow six times to reach the View Config screen.
- Select the function tick box and lock.
- Select the home icon.
- Navigate to the network page.
- Select the appropriate controller.
- Navigate to the required object, see “Exposed BACnet Object List” for a full list.
- Select any values that need password protection. A black lock indicates a locked value.

When finished, navigate back to the View Config screen in the settings section. Remove the Function tick and enable writing of values.

2.7 Security

If the target page or favourite page is selected as the home page and a security password is set, the home page will be locked. The only way to exit the target screen in this case is to press the Nuairé logo to the top right of the screen for 5 seconds. A security password will then be requested to access the main menu. The security password timeout is the same as the standby timer and set via the display settings.

2.7.1 Setting User Password

- Navigate to the settings page.
- Select the right arrow twice to reach the display settings screen.
- Change the user password a 4 digit number.
- The user password will now be requested each time a locked object is written.
- The user password is also needed to exit the target page (when the homepage is set to target).

2.7.2 Setting Service Password

- Navigate to the settings page.
- Select the right arrow twice to reach the display settings screen.
- Change the service password a 4 digit number.
- The service password will now be requested each time the settings page is accessed.

2.7.3 Disable Writing Values

- Navigate to the settings page.
- Select the right arrow six times to reach the View Config screen.
- De-select the write tickbox, all controller points are now read only.
- A service password will need to be set to stop users re-enabling the write function.

16 Allowing Writing of Values

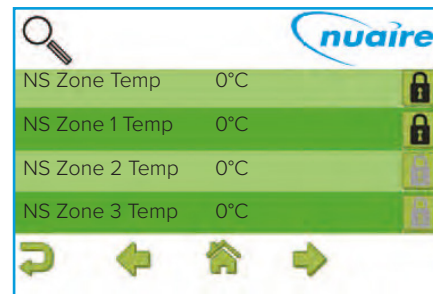

A user password will need to be set to stop writing of locked values. It is recommended that all values are locked except the following:

- Enable
- Time Schedule
- Fan Boost
- Heat Boost
- Software Setpoint

2.7.5 Setting Schedule

Schedules can be set on a supervisor device by using the following BMS points:

- Local Schedule
- NFC Schedule
- Purge Schedule
- Alarm Reset

### 2.7.6 Alarm Log

When an XBC alarm changes state, a signal is sent to the LCD display and logged on the alarm page. If there are items on the alarm page the standard top left page icons change to one of the following, depending on the current page. The alarm page can be accessed by selecting the alarm icon.

Alarm events are logged with a date and time:

- ‘Nor’ represents a change to a normal state.
- ‘Ala’ represents a change to an alarm state.
- The text in parentheses denotes the alarm the event applies to. The log can hold up to 40 events.

Logged alarm events can be deleted by using the delete icon. If all events are deleted, alarm states can still be checked by navigating to the BACnet alarm objects via the network browser page. See the BACnet alarm list for alarm objects.

The LCD can be set to sound a continuous beep when a new item is added to the alarm log. This beep is silenced by any user interaction, but the alarm event is still logged. This option can be changed via the settings page.

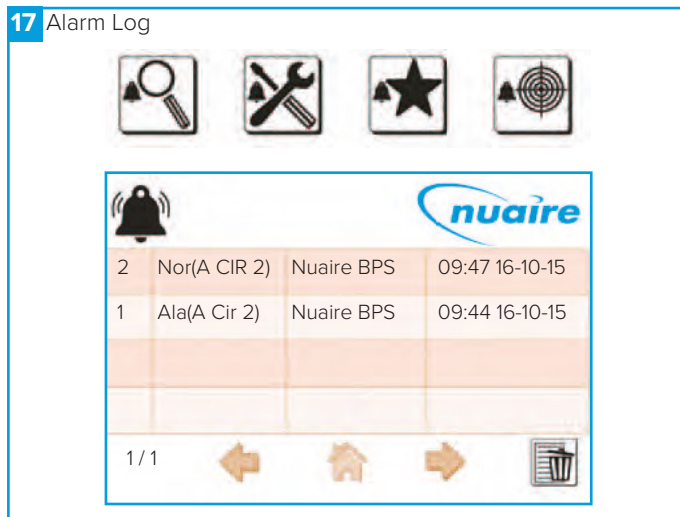

### 2.7.7 Backup

The LCD settings, favourites and locked items can be backed up to a USB drive by plugging a USB into the rear of the LCD. The screen will automatically change to a download screen. Select the item required and choose upload.

To download data to the LCD select the data type and choose download.

If a user or service password is forgotten, they can be reset by re-downloading a backup file to the LCD that has no set password. It is recommended that a backup is made of a LCD with no password set.

### 2.8 Multiple Controllers

When accessing the Network View the FAD launches a Network Discovery function. The purpose of this function is to find other BACnet devices residing on the same MS/TP trunk. The maximum number of devices supported by the FAD discovery function is 32.

### 2.9 Controller Wiring

There are 2 ways of connecting the LCD controller:

- Connected to the FC bus using screwed terminals. A separate power supply is required.
- If the controller is standalone, the LCD display can be connected to the RJ12 FC bus port on the front of the Verasys controller. This FC port will also power the LCD, so in this case, a separate power supply is not required. One of the following cables is required to achieve this:

ESCO-LCD-3M	Ecosmart-Connect LCD RJ12 Connection Cable 3m
ESCO-LCD-5M	Ecosmart-Connect LCD RJ12 Connection Cable 5m
ESCO-LCD-10M	Ecosmart-Connect LCD RJ12 Connection Cable 10m
ESCO-LCD-20M	Ecosmart-Connect LCD RJ12 Connection Cable 20m
ESCO-LCD-30M	Ecosmart-Connect LCD RJ12 Connection Cable 30m

### 18 Controller Wiring

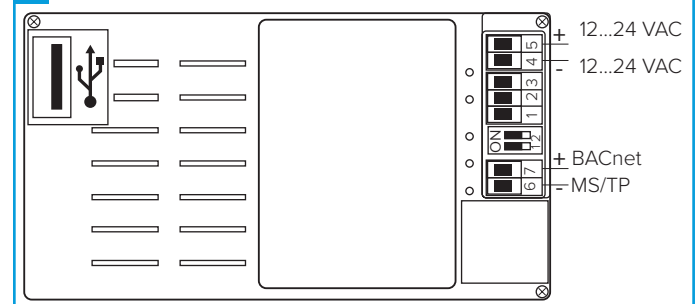

Terminals	Description
1-3	Unused
4	Power Supply (-) 12...24 VAC / VDC
5	Power Supply (+) 12...24 VAC / VDC
6	BACnet MS/TP Port (RT-)
7	BACnet MS/TP Port (RT+)
	Programming USB Port

**DIP Switch 1** BACnet MS/TP Line Terminator (End of Network 120Ω resistor switch)

**DIP Switch 2** Unused

## 2.10 Setting Pages

These set of pages allow the user to configure the technical functions of the LCD both from the BACnet and user interface perspectives.

The settings page requires a service password for access.

### 2.10.1 Network Settings Page

Allow the user to discover all devices connected on the MS/TP network and browse all objects exposed within these devices.

Parameter Name	Description	Default Setting
Device Name	It defines the BACnet Device Object Name	FAD0351
Device ID	It defines the BACnet Device Object Identifier	127
MAC Address	MSTP Address of FAD	127
Descriptions	BACnet Description of FAD	Field Advanced Display
Baud Rate	It defines the FAD communication speed over the BACnet local network.	38400
Max Info Frames	It defines the BACnet Device Object Max_Info_Frames	3
Adjust Priority	The Adjust priority parameter defines with which priority the display will command AV / BV / MV values.	16
Override Priority	The Override priority parameter defines with which priority the display will command AO / BO / MO values	8
Page Refresh Time	It defines the polling speed at which the FAD will refresh the values shown on the screen	30 sec
Max Master	This parameter represents the value of the Max_Master property of the node's Device object	127
APDU Time	The APDU Timeout property defines the amount of time, in seconds, the FAD waits for responses from other devices.	3

### 2.10.2 Display Settings Page

Parameter Name	Description	Default Setting
Backlight	It defines whether the back light remains ON or turns OFF during Standby	Stand-By ON
Homepage	It defines which page to show at power up or pressing the "Home" shortcut button	Main Menu
Service Password	Password required to enter settings page	0
User Password	Password Required to change locked values (All values are locked by default)	0
Stand By	It defines the behaviour of the display once the "Stand By Timer" has expired without interactions from the user	-
Stand By Timer	It defines the inactivity period, in minutes, required to force the display in Stand By mode and for both Service and User passwords expiration. Defining this parameter to Zero, the passwords request (if any) is prompted at any access to pages requiring them	0 min
Feedback Sound	It defines whether the device shall provide a sound feedback during user interaction	OFF
Alarm	It defines whether the device shall provide a sound feedback when receiving a new Alarm. The notification sound can be continuous (ON) or intermittent (BEEP)	OFF
Date	It adjusts settings related to the Day, Month and Year of the FAD integrated clock	
Time	It adjusts settings related to the Hour and Minute of the FAD integrated clock	
Day Of Week	It adjusts settings related to the Day of Week (1-7) of the FAD integrated clock	

2.10.3 Selecting Target Device Page

Parameter Name	Description	Default Setting
Device Name	Name of the device where the object resides	
MAC Address	The MSTP address of the device where the object resides	
Device ID	The BACnet ID of the device where the object resides	
Object Type	The object type	
Object ID	The object BACnet ID	

2.10.4 View Configuration Page

Parameter Name	Description	Default Setting
Name / Description	Chooses whether objects are described by their name or description	Name
Write	Allows editing of objects	Yes
ID	This will display the BACnet ID next to all BACnet objects on the network, favourites and target pages	Yes
Function (Favourite / Lock)	This option allows objects to be added to the favourite or locked list. Once it is selected, navigate to the network page and choose which objects are required. A user password is required to change any locked object, if set. All values are unlocked by default.	None

3.0 SA BUS DEVICES

3.1 Room Module

Room Modules are electronic, wall-mountable sensors designed to work directly with the Nuair control panel.

Room modules are automatically detected and require no set-up. The majority of RM modules monitor room temperature; however, options are available to also monitor zone humidity, carbon dioxide (CO2), local temperature setpoint adjustments, PIR, and other variables. This data is transmitted to a controller on the Sensor Actuator (SA) Bus.



3.2 Features

20 Room Module Display

Icon	Description
1	Humidity indicator icon
2	Humidity measurement
3	CO <sub>2</sub> measurement
4	Configurable setpoint or current temperature
5	Setpoint indicator icon
6	Fahrenheit icon
7	Celsius icon
8	Percent relative humidity icon
9	Fan speed bars
10	Fan icon
11	Automatic fan speed icon
12	Up adjustment or navigation icon
13	SA bus online indicator
14	Down adjustment or navigation icon
15	Menu or enter icon
16	Occupancy indicator
17	Default display value (setpoint, zone temperature, relative humidity)

3.3 Backlit LCD Display

The touch display is sensitive to surrounding capacitance and may not respond to touch when you hold the sensor in your hand. Mount the sensor vertically on the wall or place it on a flat surface to use the icons and change settings with ease.

To activate the home screen when the backlight is off, touch the screen to turn the backlight back on for ten seconds.

All icons are visible on the home screen during configuration.

3.3.1 Adjusting Temperature Setpoint

- To view the current setpoint value, press the Up or Down icon once.
- To increase or decrease the temperature setpoint by 0.5 degrees Fahrenheit or Celsius, press the Up or Down icon again.
- To save the new settings, press the Menu icon once to return to the home screen or wait for ten seconds for the screen to return to the home screen automatically.
- Press and hold the Up or Down icon to continuously increase or decrease the temperature setpoint.

3.3.2 Adjusting Fan Speed

- To view the current fan speed, press the Fan icon once.
- To adjust the fan speed, continue to press the Fan icon to cycle through the automatic, off, low, medium or high fan speed settings.
- To save the new settings, press the Menu icon once to return to the home screen or wait for ten seconds for the screen to return to the home screen automatically.

### 3.3.3 Viewing SA Bus Sensor Address And Firmware Version

- Press the Menu icon once to view the SA bus sensor address. See Table 3 for setting the SA bus sensor address
- Press the Menu icon a second time to view the firmware version.
- Press the Menu icon a third time to return to the home screen or wait for ten seconds for the screen to return to the home screen automatically.

### 3.3.4 Adjusting Temperature Unit

To change the temperature units from Fahrenheit to Celsius or Celsius to Fahrenheit, complete the following steps:

- On the home screen, press and hold the Up and Down icons for five seconds until the middle display disappears and the Celsius and Fahrenheit indicator icons blink.
- To toggle between Fahrenheit and Celsius, press the Up or Down icon.
- To save the new settings, press the Menu icon six times to return to the home screen or wait for ten seconds for the screen to return to the home screen automatically.

### 3.3.5 Changing Home Screen Default Value

Choose whether you want to display current temperature or the setpoint value in the middle of the home screen. To change which value displays in the middle of the home screen, complete the following steps:

- Press and hold the Up and Down icons for five seconds until the Fahrenheit and Celsius indicator icons start to blink. All icons are visible on the display.
- Press the Menu icon once.
- To select and switch between current temperature or setpoint value, press the Up or Down icon.
- To save the new settings, press the Menu icon five times to return to the home screen or wait for ten seconds for the screen to return to the home screen automatically.

### 3.3.6 Selecting Setpoint Display Value

To change whether current temperature or setpoint temperature displays in the upper-right corner, complete the following steps:

- Press and hold the Up and Down icons for five seconds until the Fahrenheit and Celsius indicator icons start to blink.
- Press the Menu icon twice.
- To select and switch between current temperature or setpoint value, press the Up or Down icon.
- To save the new settings, press the Menu icon four times to return to the home screen or wait for ten seconds for the screen to return to the home screen automatically.

### 3.3.7 Selecting Maximum Fan Speed Settings

The fan speed is set to high speed by default. To change the value of the maximum fan speed that displays on the home screen, complete the following steps:

- Press and hold the Up and Down icons for five seconds until the Fahrenheit and Celsius indicator icons start to blink.

- Press the Menu icon three times.
- To increase or decrease the maximum fan speed, press the Up or Down icon.
- To save the new settings, press the Menu icon three times to return to the home screen or wait for ten seconds for the screen to return to the home screen automatically.

## 3.4 Sensor Installation

Location considerations when locating the network sensor:

- On a partitioning wall, approximately 5 ft (1.5m) above the floor in a location of average temperature.
- Away from direct sunlight, radiant heat, outside walls, outside doors, air discharge grills, or stairwells; and from behind doors.
- Away from steam or water pipes, warm air stacks, unconditioned areas (not heated or cooled), or sources of electrical interference.

### 3.4.1 Removing Sensor Rear Cover

- Use a Pozi screwdriver to loosen the screw on the top of the unit.
- Insert a coin into the slot next to the security screw location, pressing the tab that keeps the unit closed. Then carefully pry the top edge of the sensor assembly away from its mounting base and remove.

### 3.4.2 Modular Jack

For the modular jack, simply snap the wiring plug into the jack. A modular jack requires a straight-through, one-to-one connection (not a crossover). See interconnection section for details.

### 3.4.3 Room Module Wiring





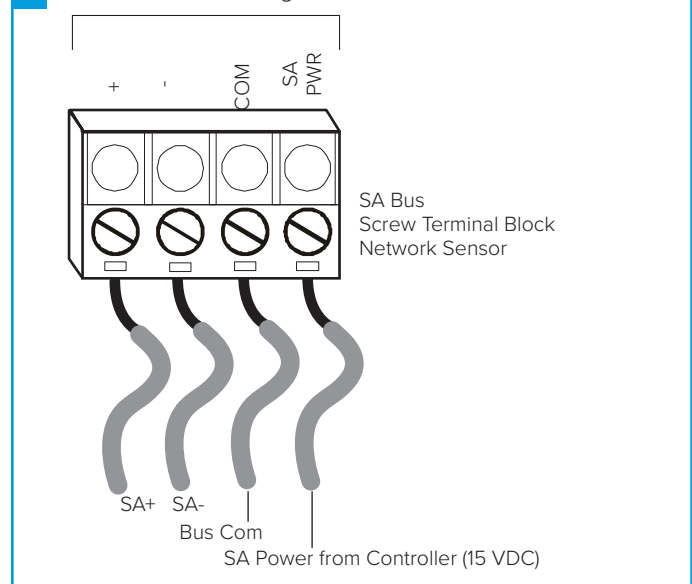



Screw terminal wiring: If RJ12 cables are not used, the screw terminal connections on the Room Modules can be used.

#### 21 Standard Sensor Wiring



3.5 Available Room Modules

The following room modules are available:

Part Number	Temperature Sensor	Humidity Sensor	LCD, Setpoint Adjust & Occupancy Display	PIR	Fan Speed Override	Fan Status Display	CO2 Sensor	Sensor Image
ESCO-TS2	YES							
ESCO-THS2	YES	YES						
ESCO-TPL2	YES			YES				
ESCO-THPL2	YES	YES		YES				
ESCO-TDFS2	YES		YES		YES	YES		
ESCO-TDHS2	YES	YES	YES		YES	YES		
ESCO-TDPL2	YES		YES	YES	YES	YES		
ESCO-TDHPL2	YES	YES	YES	YES	YES	YES		
ESCO-CL2							YES	



### 3.6 Sensor Addressing

Each sensor on the SA bus must have a unique address. The default controller strategy is preconfigured to automatically detect all Room Modules on the network and react accordingly.

Network Page	Description	Module Type
199-206	Adjustable	All

#### 22 Network Sensor Addressing

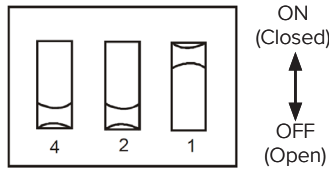

Address	Switch Settings		
	Switch 4	Switch 2	Switch 1
199	Off	Off	Off
200	Off	Off	On
201	Off	On	Off
202	Off	On	On
203	On	Off	Off
204	On	Off	On
205	On	On	Off
206	On	On	On

**SA bus applications are limited to a power load of 210 mA. The best practice when configuring an SA bus is to limit the total available operating power consumption to 120 mA or less. This power level allows you to connect a BTCVT Wireless Commissioning Converter temporarily or a DIS1710 Local Controller Display to the bus for commissioning, adjusting, and monitoring.**

### 3.7 Room Module Technical Specifications

Supply Voltage	
Current Consumption	
Temperature Measurement Range	
Temperature Sensor Type	
Humidity Measurement Range	
Humidity Sensor Type	
Temperature Resolution (Models with LCD)	±0.5°C
Default Temperature Setpoint Adjustment Range	12 to 28°C
PIR Occupancy Sensor Motion Detection	Minimum 94 Angular Degrees up to a distance of 15 ft (4.6m); Based on a clear line of sight.
Ambient Operating Conditions	10 to 30°C, 10 to 90% RH (Temp Probe -10 to 60°C)
Ambient Storage Conditions	-20 to 60°C, 5 to 95% RH
CO2 Sensor Warm Up Time	Less than 1 Minute; less than 10 minutes for full accuracy.
Dimensions (Height x Width x Depth)	85.3 mm x 127.55 mm x 26.8 mm

### 3.8 Interconnection

The sensors or other devices on the SA bus network connect either by modular RJ12 connections or by screwed terminals using plain ended cable. All sensors are fitted with both.

#### 3.8.1 Modular Cable (Up To 30m)

The Room Modules can connect using a 24AWG twisted 3-pair cable with RJ12 connections over the Sensor Actuator (SA) bus. The following items are available:

ESCO-C3M	3m Prefabricated sensor cable with modular jacks
ESCO-C5M	5m Prefabricated sensor cable with modular jacks
ESCO-C10M	10m Prefabricated sensor cable with modular jacks
ESCO-C20M	20m Prefabricated sensor cable with modular jacks
ESCO-C30M	30m Prefabricated sensor cable with modular jacks
ESCO-2WA	2-port extension adapter
ESCO-3WA	3-port extension adapter

Room Modules must not be fitted more than 30metres (cable length) from the controller when using this connection method.

#### 3.8.2 Plain Cable (30 - 150m)

If a Room Module is to be fitted more than 30metres (cable length) from a controller, the following cable is recommended.

ESCO-MSTPC30M	Ecosmart Connect MSTP cable reel 30m
ESCO-MSTPC150M	Ecosmart Connect MSTP cable reel 150M

**On the SA Bus, the + and - wire are one twisted pair, and the COM and SA PWR are the second twisted pair of wires.**

These cannot be used with RJ12 connections and must be stripped and connected using screwed terminals. The shield must be earthed at the control panel end only and be made continuous along the bus length.

Room Modules must not be fitted more than 150metres (cable length) from the controller.

3.9 Modular Jack Network

23 Modular Jack Network

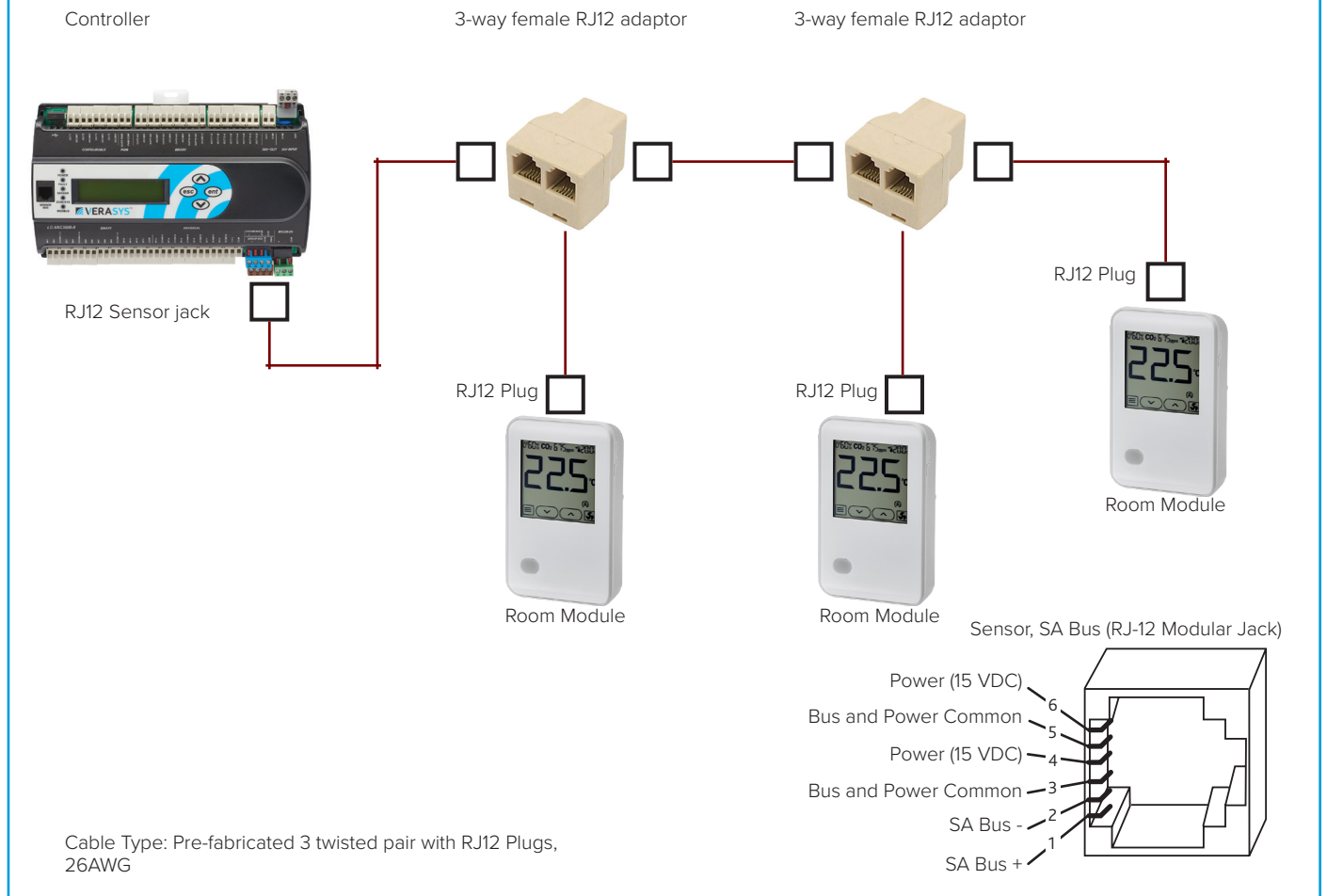

3.10 Terminal Network

24 Terminal Network

