

NTD-125/204/220-*



NTD All-in-One Connector with Ductmaster Rectangular and Circular Thermal Ducting. Installation and Maintenance Manual

1.0 SAFETY INFORMATION

1.1 Symbols



REFER TO INSTRUCTION MANUAL

Read and understand the installation and maintenance manual before installing, operating or maintaining this product.

1.2 Important Information

This manual contains important information on the safe and appropriate assembly, transport, commissioning, operation, maintenance, disassembly and simple troubleshooting of the product.

While the product has been manufactured according to the accepted rules of current technology, there is still a danger of personal injury or damage to equipment if the following general safety instructions and the warnings contained in these instructions are not complied with.

- **Read these instructions completely and thoroughly before working with the product.**
- **Keep these instructions in a location where they are accessible to all users at all times.**
- **Always include the operating instructions when you pass the product on to third parties.**

1.3 Personal Protective Equipment

The following minimum Personal Protective Equipment (PPE) is recommended when interacting with Nuaire product:

- **Protective Steel Toed Shoes** - when handling heavy objects.
- **Full Finger Gloves (Marigold PU800 or equivalent)** - when handling sheet metal components.
- **Semi Fingerless Gloves (Marigold PU3000 3DO or equivalent)** - when conducting light work on the unit requiring tactile dexterity.
- **Safety Glasses** - when conducting any cleaning/cutting operation or exchanging filters.
- **Reusable Half Mask Respirators** - when replacing filters which have been in contact with normal room or environmental air.

Nuaire would always recommend a site specific risk assessment by a competent person to determine if any additional PPE is required.

2.0 INTRODUCTION

2.1 Nuaire Thermal Ducting (NTD)

Nuaire Thermal Ducting (NTD) is a range of ducting and ancillaries intended for installation in domestic properties.

Nuaire Thermal Ducting is available in three different sizes and profiles, based on the internal dimension: 125mm diameter or 204 x 60mm and 220 x 90mm rectangular.

Using Nuaire Thermal Ducting will achieve a level of leakage substantially lower than the maximum allowed for a class A duct as defined in DW/143 (Ductwork leakage testing).

2.2 One Piece Connector Clamps

Nuaire Thermal Ducting one piece connector clamps are available to match 125mm diameter or 204 x 60mm or 220 x 90mm rectangular duct.

1 Circular & Rectangular One Piece Connector Clamps

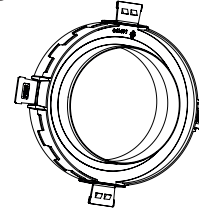

NTD-125-OPC

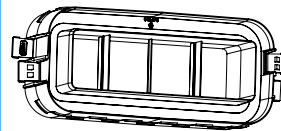

NTD-204-OPC

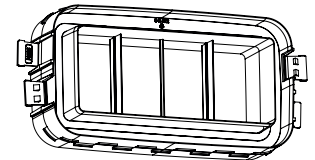

NTD-220-OPC

3.0 INSTALLATION

Installation must be carried out by competent personnel in accordance with the appropriate authority and conforming to all statutory governing regulations.

The ducting must be installed indoors, on a suitable vibration-free solid surface away from direct sources of frost, heat, and water spray or moisture generation.

Prior to installation a dimensional check of the chosen installation location should be undertaken to ensure suitability.

Do not place heavy objects on the ducting as this could cause distortion or breakage. Distorted ducting could result in airflow leakage at the seal joint with the connector.

2 Rectangular Ducting Installation

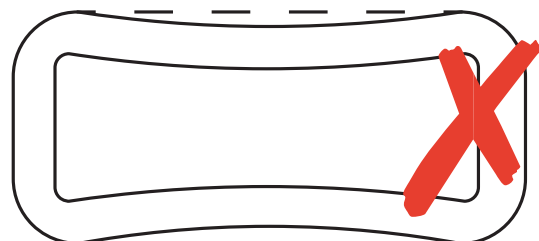

3.1 Flexible Ducting Connections

3.1.1 MVHR Unit To Thermal Ducting Plenums / Bends

Where it is necessary to use semi-rigid acoustic flexible duct between the MVHR unit and a plenum or bend please ensure that a rigid 125mm diameter PVC duct connector is installed into the plenum or bend for successful connection.

3 Typical semi rigid acoustic flexible duct connection between MVHR and thermal plenum / bend.

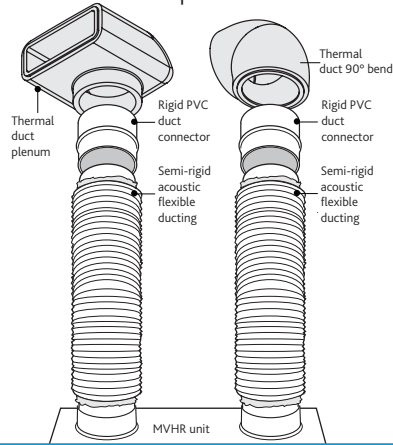

3.1.2 Air Valve To Circular Thermal Ducting Plenums / Bends

4 Typical semi rigid acoustic flexible duct connection between air valve and thermal plenum / bend.

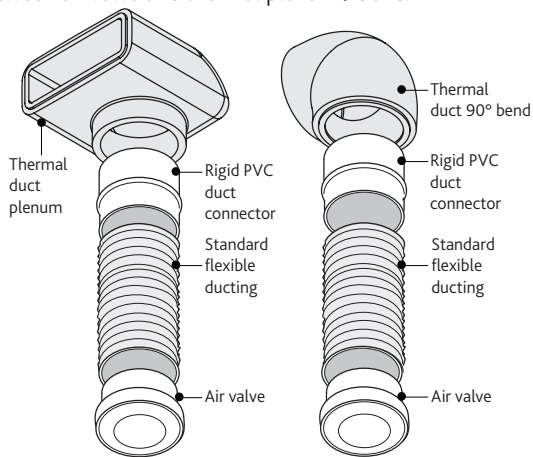

3.2 Condensate Trap in Circular Thermal Ducting

5 Condensate trap with rigid PVC duct connectors.

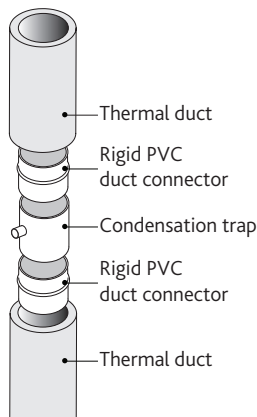

3.3 Rectangular Thermal Ducting Connections

3.3.1 Air Brick

6 Typical rectangular thermal duct connection to air brick.

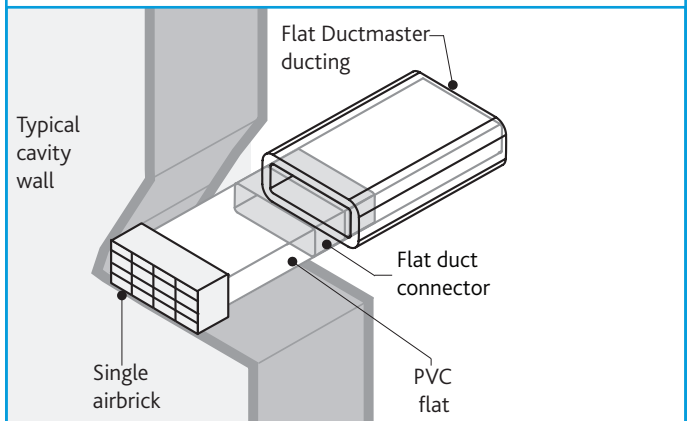

3.3.2 Fire Wrap to Thermal Ducting Using PVC Duct Connections

Cut PVC ducting approximately 150mm longer than the fire wrap and fit ducting through fire wrap.

Fit duct connectors both ends of PVC ducting and seal with foil tape. Apply Galvmate generously between outer surface of duct connector and thermal ducting.

Using foil tape, seal joint between fire wrap and thermal ducting and seal joints between fire wrap and wall with intumescent sealant.

7 Typical fire wrap installation using PVC duct connections.

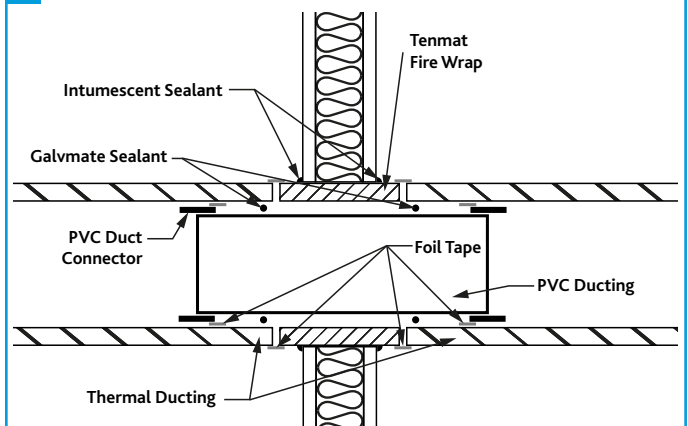

3.3.3 Fire Wrap to Thermal Ducting Using Duct Inserts Only

Cut PVC ducting to same length as fire wrap, fit duct insert in place and seal with foil tape.

Cut fire wrap along length as shown, wrap fire wrap around PVC ducting and seal using tape supplied.

Fit assembly into wall structure and fit thermal ducting to duct insert, seal using galvmate.

Using foil tape, seal joint between fire wrap and thermal ducting and seal joints between fire wrap and wall with intumescent sealant.

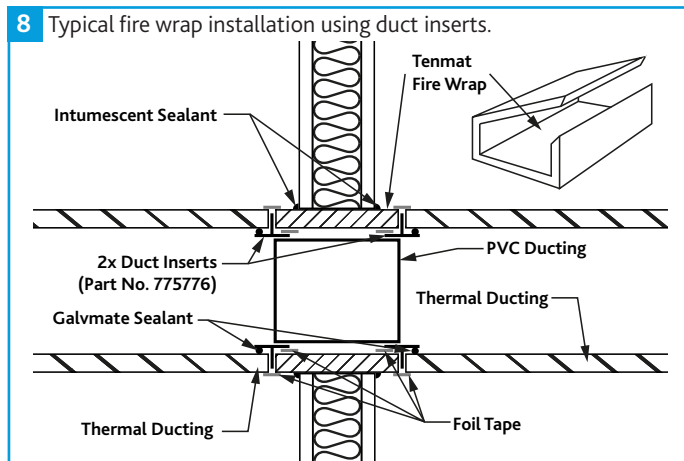

3.3.4 Attenuator

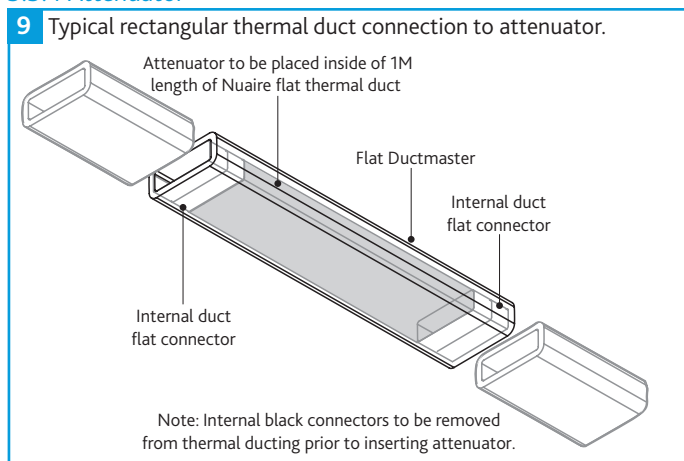

3.4 Cutting Thermal Ducting

A flush, square 90° cut is required to ensure that an air tight seal is made with centre ridge in the clamp. If an angled cut is made, this will not allow the duct clamps to create a seal on the duct. We advise that the duct is cut with a very sharp blade or fine toothed saw (we recommend a minimum of 14 teeth per inch). The cutting blade length should be at least the same length as the wall thickness of the ducting.

Ensure duct is placed into duct clamp connector prior to installation to check the squareness of the cut ducting.

Nuair Thermal Ducting is supplied in 1 metre lengths. If shorter lengths are required the duct can be cut to the desired length with a fine toothed saw (minimum of 14 teeth per inch). Failure to make a square cut may result in airflow leakage when connecting to other ducting pieces. Ensure duct is placed into the duct clamp connector prior to installation to check the squareness of the cut ducting (Figure 10).

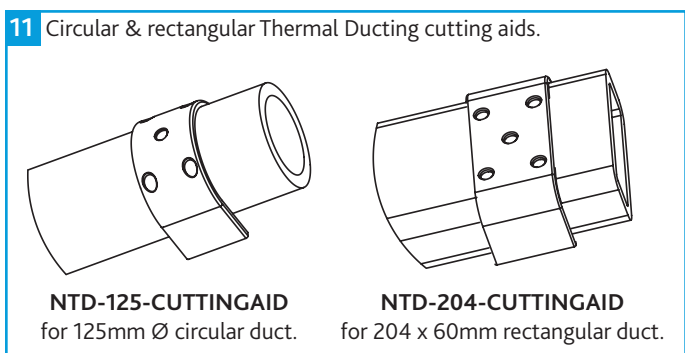
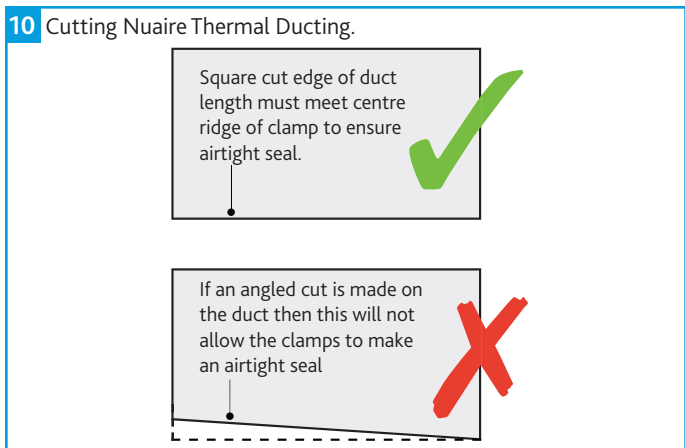

3.5 Connector / Clamp Installation

3.5.1 One Piece Connector Clamps

For installation into the duct clamp, push the 2 pre-cut lengths of ducting firmly into the clamp at opposite ends.

Double check the squareness of the cut ducting. Failing to do so may cause air leakage.

The centre joint of the duct lengths should be located on the centre flange of the clamp.

Ensure the ducting is fully pressed into the clamp to create an air tight seal. Failing to do so may cause air leakage.

Press the fixing tabs down until they lock in place.

The connector pieces are designed for single fix use. The ducting system or ducting section should be assembled and fixed in place prior to closing the fixing tabs on the connector pieces. If the connector pieces need to be removed, care should be taken to release the fixing tabs without excessive force as this can damage the fixing tabs and/or ducting.

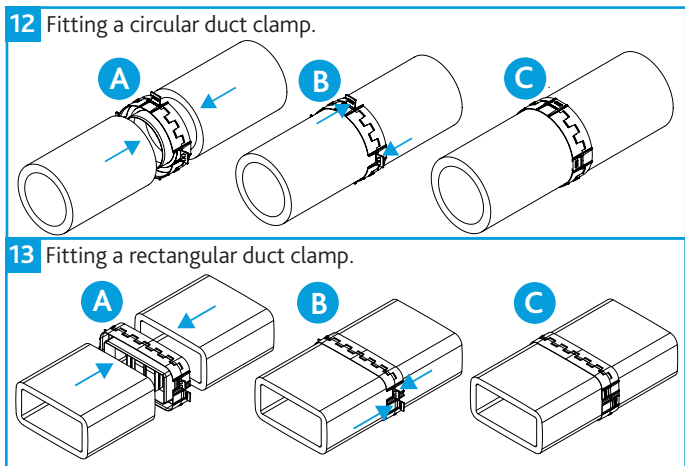

3.5.2 Black Inner Connectors With Sealant

For connection of thermal ducting with inner duct connectors we recommend the use of Galva Mate, solvent free low odour sealant. Sealant should be applied in the middle of the connection face with a minimum bead width of 5mm.

Fit ducting over connector ensuring end face butts up to connector shoulder. Allow minimum of 1 hour curing time at room temperature.

14 Fitting inner connectors with sealant.

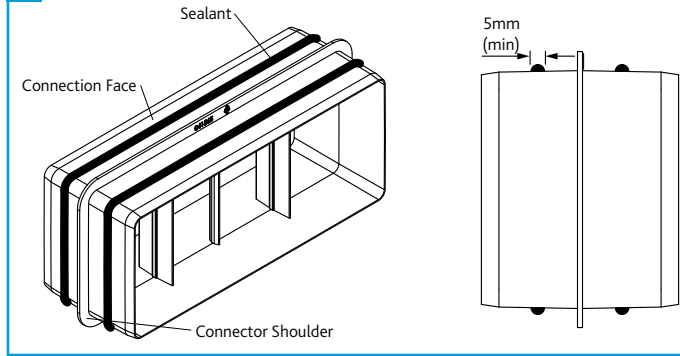

3.6 Thermal Ducting Banding

For installation onto a solid surface, suitable duct banding must be used to support both the rectangular and circular ducting and should be fitted every 1m. When fitting the bands at the fixing clamps the raised tabs provided will act as an installation guide.

Nuair recommend the use of PVC coated galvanised banding available under item code PVCBAND. As an alternative, uncoated galvanised banding may also be used.

In both cases, if banding is used on the duct itself and not at the fixing clamp then care should be taken to ensure the banding does not cut into the surface as this may cause damage and ultimately lead to leakage.

15 Fitting duct banding.

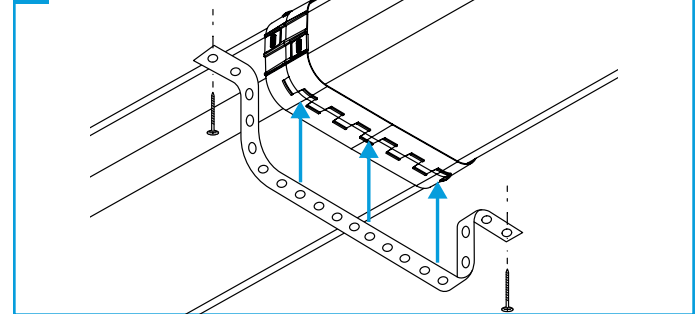

3.7 MVHR With Rectangular Thermal Duct Installation

17 Typical MVHR With 204 x 60 mm Rectangular Thermal Ducting Installation

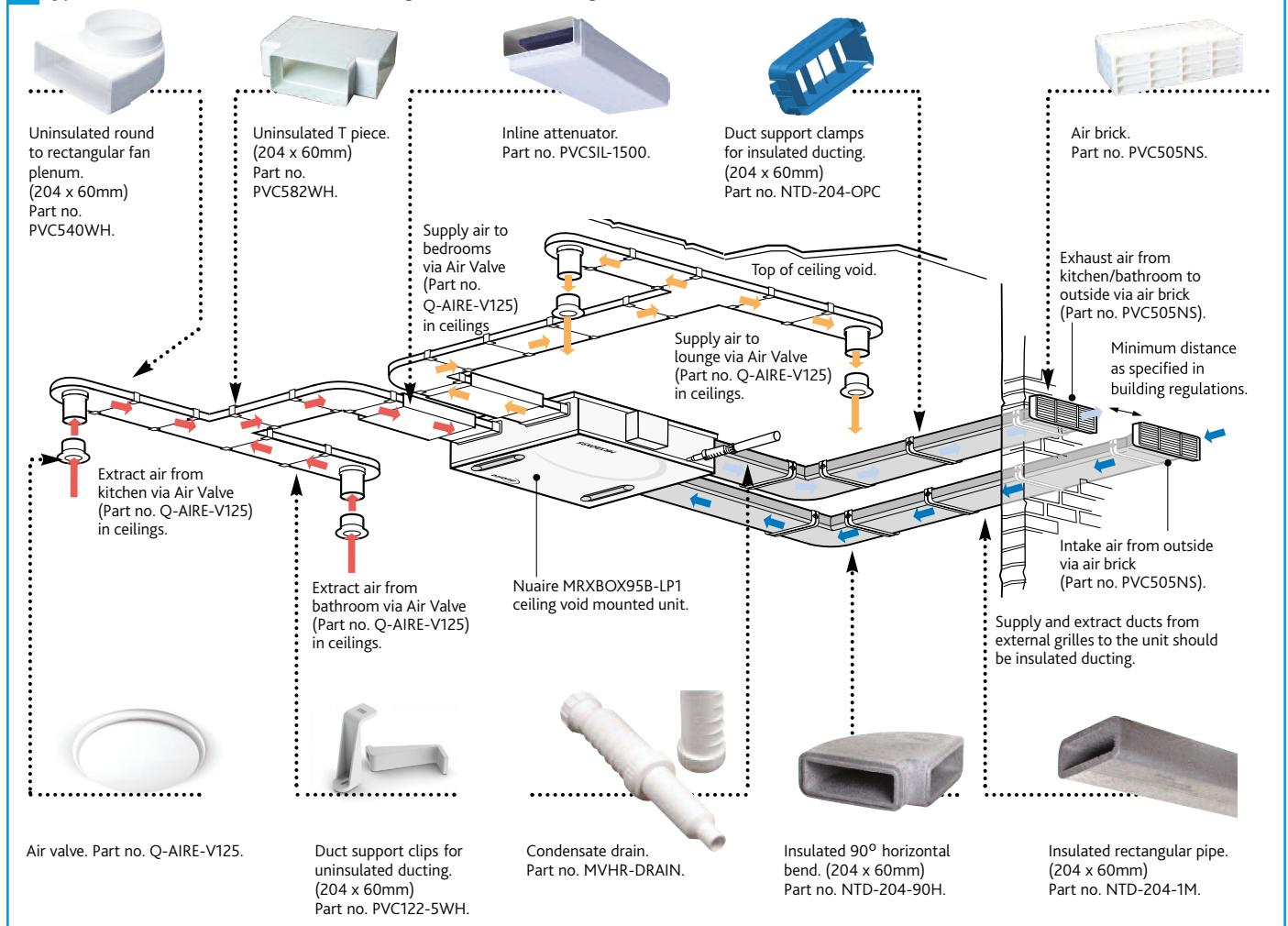

4.0 END-OF-LIFE AND RECYCLING

Where possible Nuaire use components which can be largely recycled when the product reaches its end-of-life:

- Fans, motors, controls, actuators, cabling and other electrical components can be segregated into WEEE recycling streams.
- Sheet metal parts, aluminium extrusion, heating/cooling coils and other metallic items can be segregated and fully recycled.
- EPP, plastic ducting, nylon corner pieces, plastic heat exchangers, packaging material and other plastic components can be segregated into mixed plastic and widely recycled.
- Cardboard packaging, wood, used filters and other paper components can be largely recycled or fully processed in energy from waste centres.
- Remaining Items can be further segregated and processed in accordance with the zero waste hierarchy. Please call After Sales Support for further information on items not listed above.

IMPORTANT

Ensure that Nuaire product is made safe from any electrical / water / refrigerant supplies before dismantling commences. This work should only be undertaken by a qualified person in accordance with local authority regulations and guidelines, taking into account all site based risks.

5.0 AFTER SALES AND REPLACEMENT PARTS

For technical assistance or further product information, including spare parts and replacement components, please contact the After Sales Department.

If ordering spares please quote the serial number of the unit together with the part number, if the part number is not known please give a full description of the part required. The serial number will be found on the identification plate attached to the unit casing.

Telephone 02920 858 400
aftersales@nuaire.co.uk

Technical or commercial considerations may, from time to time, make it necessary to alter the design, performance and dimensions of equipment and the right is reserved to make such changes without prior notice.

Range Details - 125mm diameter Ducting

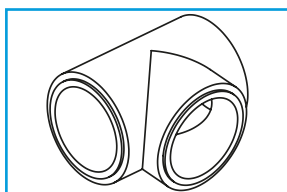

INSULATED "T" PIECE

Part Number	Duct Size	Description
NTD-125-TP	125mm Ø	Insulated T Piece

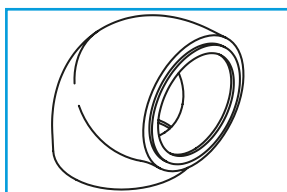

INSULATED 90° BEND

Part Number	Duct Size	Description
NTD-125-90H	125mm Ø	Insulated 90° Bend

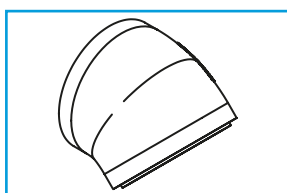

INSULATED 45° BEND

Part Number	Duct Size	Description
NTD-125-45H	125mm Ø	Insulated 45° Bend

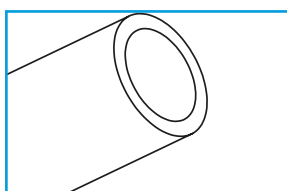

INSULATED DUCT 1M LENGTH

Part Number	Duct Size	Description
NTD-125-1M	125mm Ø	Insulated Duct 1m Length

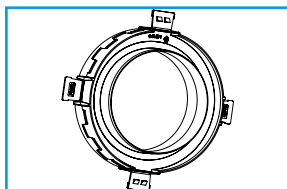

ROUND DUCT CLAMP FOR INSULATED DUCT

Part Number	Duct Size	Description
NTD-125-OPC	125mm Ø	One Piece Connector & Duct Clamp

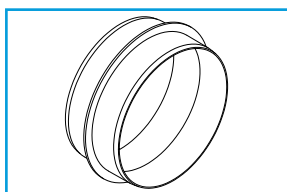

ROUND DUCT CONNECTION FOR INSULATED DUCT

Part Number	Duct Size	Description
NTD-125-INS	125mm Ø	Inner Duct Connector

Range Details - 204 x 60 mm Ducting

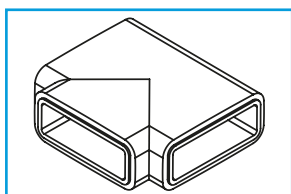

INSULATED "T" PIECE

Part Number	Duct Size	Description
NTD-204-TP	204mm x 60mm	Insulated T Piece

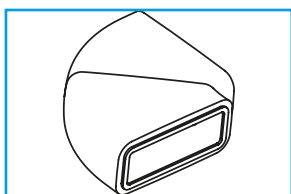

INSULATED 90° HORIZONTAL BEND

Part Number	Duct Size	Description
NTD-204-90H	204mm x 60mm	Insulated 90° Horizontal Bend

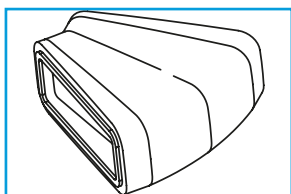

INSULATED 45° HORIZONTAL BEND

Part Number	Duct Size	Description
NTD-204-45H	204mm x 60mm	Insulated 45° Horizontal Bend

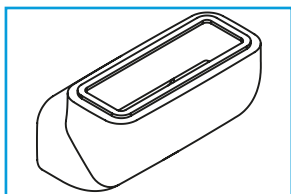

INSULATED 90° VERTICAL BEND

Part Number	Duct Size	Description
NTD-204-90V	204mm x 60mm	Insulated 90° Vertical Bend

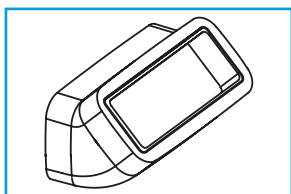

INSULATED 45° VERTICAL BEND

Part Number	Duct Size	Description
NTD-204-45V	204mm x 60mm	Insulated 45° Vertical Bend

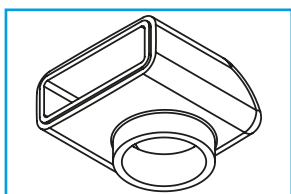

INSULATED PLENUM

Part Number	Duct Size	Description
NTD-204-PL	204mm x 60mm	Insulated Plenum

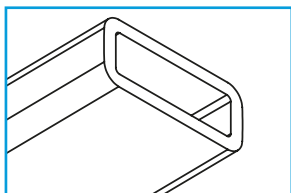

INSULATED DUCT 1M LENGTH

Part Number	Duct Size	Description
NTD-204-1M	204mm x 60mm	Insulated Duct 1m Length

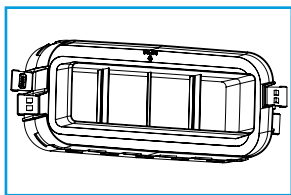

RECTANGULAR DUCT CLAMP FOR INSULATED DUCT

Part Number	Duct Size	Description
NTD-204-OPC	204mm x 60mm	One Piece Connector & Duct Clamp

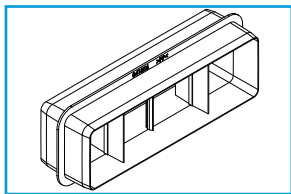

RECTANGULAR DUCT CONNECTION FOR INSULATED DUCT

Part Number	Duct Size	Description
NTD-204-INS	204mm x 60mm	Inner Duct Connector

Range Details - 220 x 90 mm Ducting

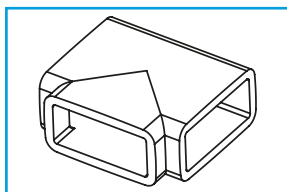

INSULATED "T" PIECE

Part Number	Duct Size	Description
NTD-220-TP	220mm x 90mm	Insulated T Piece

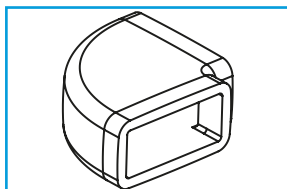

INSULATED 90° HORIZONTAL BEND

Part Number	Duct Size	Description
NTD-220-90H	220mm x 90mm	Insulated 90° Horizontal Bend

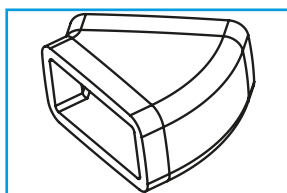

INSULATED 45° HORIZONTAL BEND

Part Number	Duct Size	Description
NTD-220-45H	220mm x 90mm	Insulated 45° Horizontal Bend

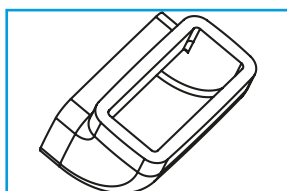

INSULATED 90° VERTICAL BEND

Part Number	Duct Size	Description
NTD-220-90V	220mm x 90mm	Insulated 90° Vertical Bend

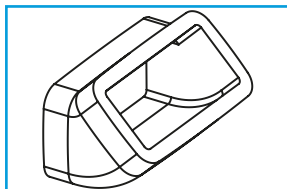

INSULATED 45° VERTICAL BEND

Part Number	Duct Size	Description
NTD-220-45V	220mm x 90mm	Insulated 45° Vertical Bend

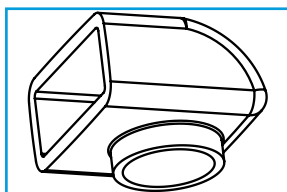

INSULATED PLENUM

Part Number	Duct Size	Description
NTD-220-PL	220mm x 90mm to 125mm Ø	Insulated Plenum

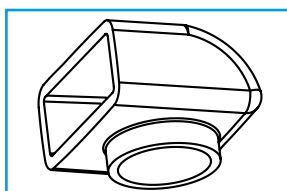

INSULATED PLENUM

Part Number	Duct Size	Description
NTD-220-PL150	220mm x 90mm to 150mm Ø	Insulated Plenum

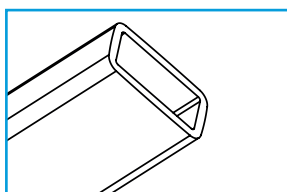

INSULATED DUCT 1M LENGTH

Part Number	Duct Size	Description
NTD-220-1M	220mm x 90mm	Insulated Duct 1m Length

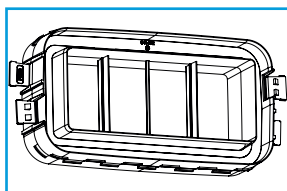

Part Number	Duct Size	Description
NTD-220-OPC	220mm x 90mm	One Piece Connector & Duct Clamp

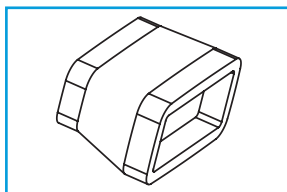

INSULATED 220 x 90 TO 204MM REDUCER

Part Number	Duct Size	Description
NTD-220-RED204	220 90 to 204mm x 60mm	Insulated 220 x 90 to 204mm Reducer

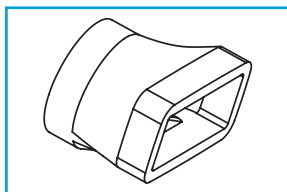

INSULATED 220 x 90 TO 125MM DIAMETER ADAPTOR

Part Number	Duct Size	Description
NTD-220-STR125	220 x 90 to 125mm Dia.	Insulated 220 x 90 to 125mm Rectangular to Round In-line Adaptor

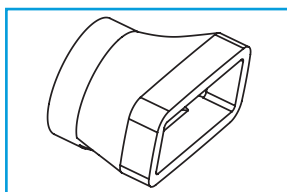

INSULATED 220 x 90 TO 150MM DIAMETER ADAPTOR

Part Number	Duct Size	Description
NTD-220-STR150	220 x 90 to 150mm Dia.	Insulated 220 x 90 to 150mm Rectangular to Round In-line Adaptor

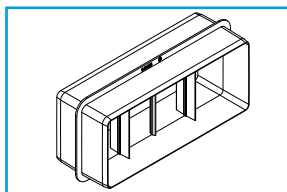

RECTANGULAR DUCT CONNECTION FOR INSULATED DUCT

Part Number	Duct Size	Description
NTD-220-INS	220mm x 90mm	Inner Duct Connector

NOTES

Lined area for notes, consisting of multiple horizontal blue lines.

