



ES-TC TIMECLOCK

Extra Low Voltage User Control

ES-TC Timeclock

Designed to be compatible with the Ecosmart system, this timeclock is supplied with a pre-plugged, 10 metre length of communications cable. Note: longer lengths are available if required.

The unit operates with Safe Extra Low Voltage (SELV) with power supplied from the fan unit via the communications cable.

The ES-TC timeclock will switch the system on and off at pre-determined times set by the user.

This digital timeclock will override the user control for effective on/off operation.

The timeclock operates on Safe Extra Low Voltage and is powered from the fan control module. The connection is made into any 'NET' socket on the fans integral control module.

Parts check list:

- 1 off ES-TC Timeclock.
- 1 off 10 metre length of plugged SELV cable.

Handling

Always handle the controls carefully to avoid damage and distortion.

Installation

The installation must be carried out by competent personnel in accordance with the appropriate authority and conforming to all statutory and governing regulations i.e. IEE, CIBSE, CCHSE, HVCA etc.

The unit is suitable for indoor use only. Mount on a secure, vibration free vertical surface away from any direct source of heat and areas where it would be subjected to waterspray. The maximum permissible ambient temperature is 40°C.

Figure 1.

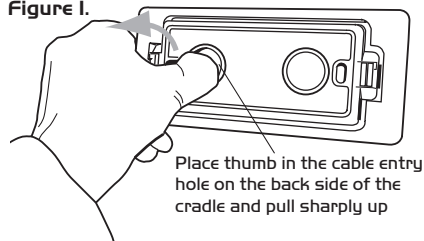

Place thumb in the cable entry hole on the back side of the cradle and pull sharply up

a) Removing the mounting cradle from the backing plate on the rear of the control. Insert your thumb in a cable entry hole and lift sharply. See figures 1 and 2. Offer the cradle to the selected mounting position, mark and fix.

Figure 2.

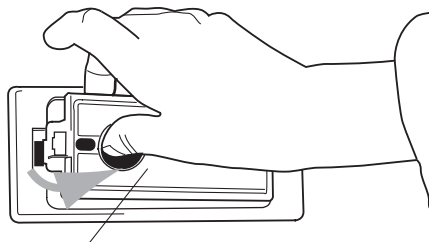

Remove mounting cradle from backing plate to affix to selected mounting position

b) Draw approx. 75mm of data cable through the cradle and plug in to the rear socket of the control, paying particular attention to plug/socket colour code for correct orientation.

Figure 3.

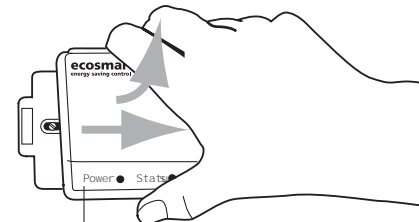

Front of Control being removed from backing plate

c) Clip the control into the cradle.

d) Removing the control module from the backing plate. Press firmly on either side of the control, strain sharply across to the right and lift the left hand side of the control module out. See figure 3.

The matched frequency inverter will have been pre programmed to suit the user control prior to delivery.

Install the inverter in accordance with the instructions provided with it.

Connect the other end of the data cable to the inverter, remove the plug from the data cable and terminate, following the instructions provided with the inverter.

Unit dimensions & weights

Figure 4.

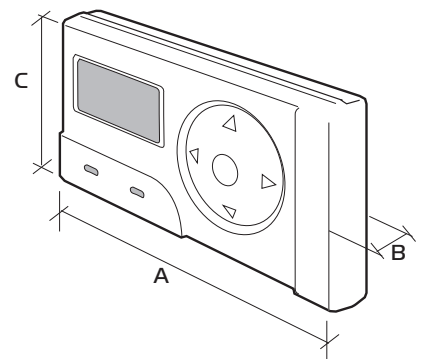

	A	B	C	Weight
Unit Dims.	163	23	75	0.25 Kg

Drill pattern & fixing detail

Figure 5.

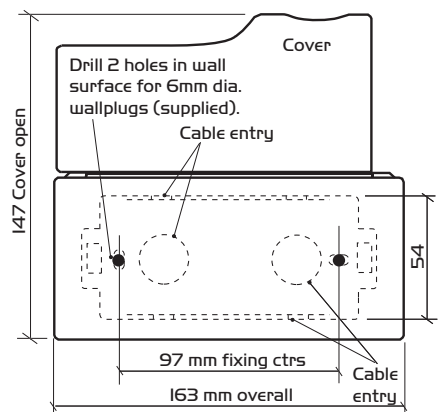

Data cable installation

A 4-core 10 metre length of SELV data cable is used to connect devices. Longer lengths are available if required.

Do not run data cable in the same conduit as the mains cables and ensure there is a 50mm separation between the data cable and other cables. The maximum cable run between any two devices is 300m when it is installed in accordance with the instructions.

Operating the control

Follow the instructions to set the time/weekday etc and program your chosen on/off times etc.

On the fascia a Green LED indicates unit is working.

If the 'STATUS' LED shows Red it indicates a fault in the system.

The ES-TC provides a signal to operate the Ecosmart fans linked via the 'NET' connections. If the ES-TC is in the 'OFF' position, this will override other enabling devices such as ES-PIR.

Note: The switched live signal operates independently from other enablers. Individual fans can be switched 'ON' via the switched live even if the ES-TC is in the 'OFF' position. The ES-TC can pre-set the operating signal to 'TRICKLE' or 'BOOST' (see setting 'ON' level). However, if another device is connected which can set the fan speed (eg. CO2 sensor or User control etc.) the ES-TC setting will be ignored.

Basic Operating Functions

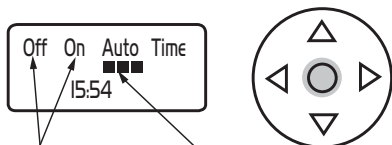

Option will flash to show state of timer
Automatic mode has been selected

Pressing the centre button selects the next operating mode

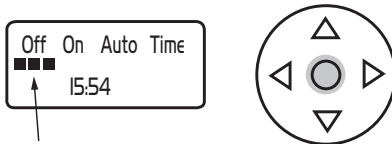

Manual OFF mode is selected

Pressing the centre button selects the next operating mode

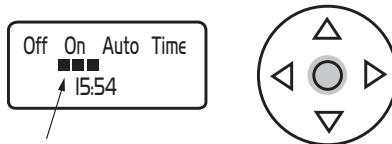

Manual ON mode is selected

Pressing the centre button selects the next operating mode and brings us back to

Setting the Time

Screen is set to Auto mode
(See basic operating instructions)

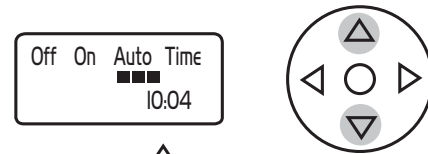

Pressing the buttons together will display the set clock option

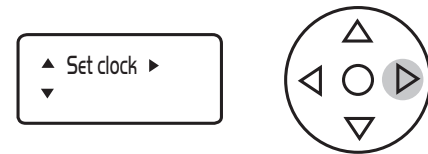

Press the button to see the Time setting

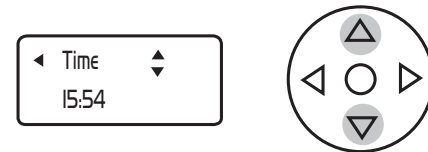

Increase or decrease by pressing either button. Hold button down to run quickly through hours. Shorter presses set minutes



When you are finished, fix the chosen Time by pressing the centre button to exit programming mode or press to continue to program other settings

Setting the Weekday

Screen is set to Auto mode
(See basic operating instructions)

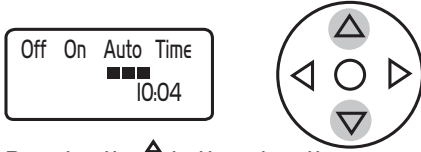

Pressing the \blacktriangle \blacktriangledown buttons together will display the set clock option

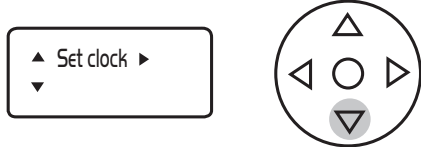

Press the \blacktriangledown button twice to move to program setting

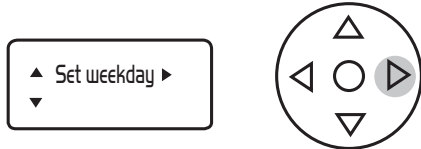

Press \blacktriangleright button to select the weekday option

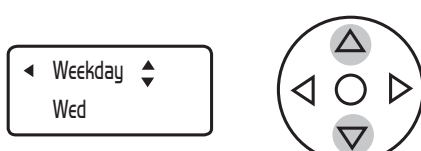

Press the \blacktriangle or \blacktriangledown button to select the weekday required

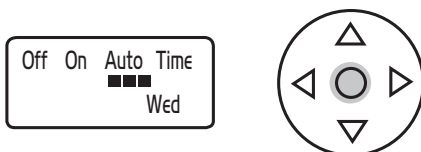

When you are finished, fix the chosen weekday by pressing the centre \bigcirc button to exit programming mode or press \blacktriangleleft to continue to program other settings

Note: The Weekday setting will flash alternately with the Time setting. To set the time see previous notes.

Setting the Program

Screen is set to Auto mode
(See basic operating instructions)

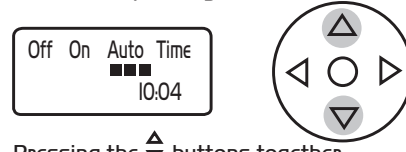

Pressing the \blacktriangle \blacktriangledown buttons together will display the set clock option



Press the \blacktriangledown button twice to move to program setting

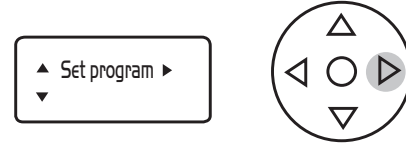

Press \blacktriangleright button to see the program setting (21 programs)

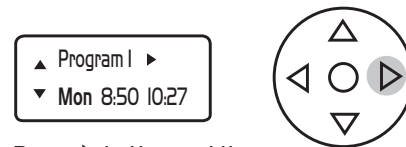

Press \blacktriangleright button and the weekday will flash

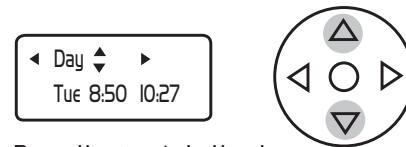

Press the \blacktriangleleft or \blacktriangleright button to select the day required

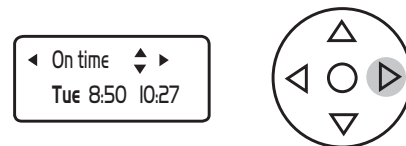

Press the \blacktriangleright button and the On time will flash

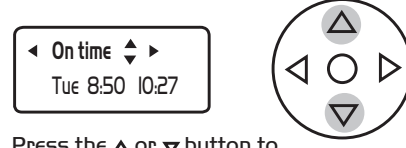

Press the \blacktriangle or \blacktriangledown button to select the On time required



Press the \blacktriangleright button and the Off time will flash



Press the \blacktriangle or \blacktriangledown button to select the Off time required

When you are finished, fix the chosen program by pressing the centre \bigcirc button to exit program mode or press \blacktriangleleft to continue programming

Canceling a Program

Screen is set to Auto mode
(See basic operating instructions)

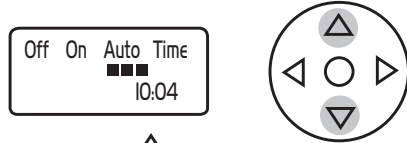

Pressing the Δ buttons together will display the set clock option

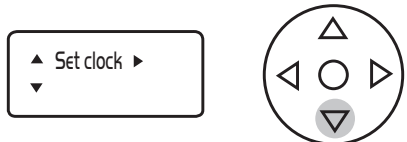

Press the ∇ button twice to move to program setting

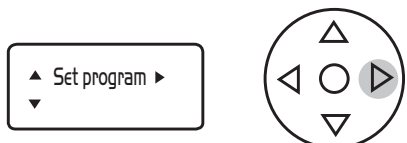

Press \blacktriangleright button to see the program setting (21 programs)

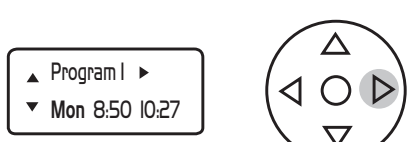

Press \blacktriangleright button and the weekday will flash

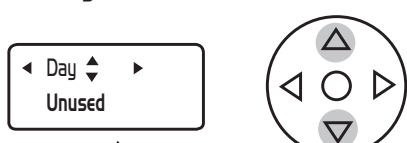

Press the Δ buttons until UNUSED is shown

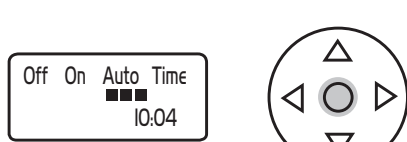

Press the centre \bigcirc button to exit programming and return to normal menu

Setting on the level

Note: The On level is only used when the system is operated without a manual speed control function in the system. The On level will be overridden by any speed control or User control in the system

Screen is set to Auto mode
(See basic operating instructions)

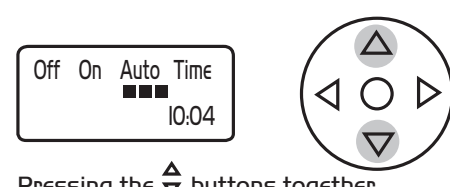

Pressing the Δ buttons together will display the set clock option.

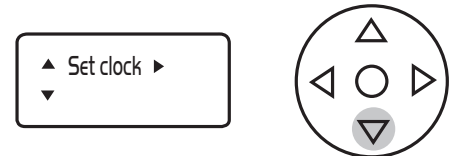

Press the ∇ button three times to see the Set On level option

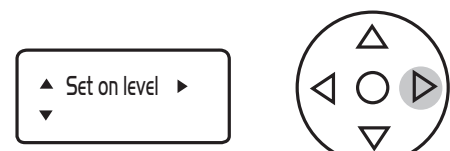

Press \blacktriangleright button to select Level set



Set Trickle or Boost by pressing either Δ buttons



When you are finished, fix the chosen On level by pressing the centre \bigcirc button

Maintenance

The user control does not require any maintenance. However, for optimum performance, it is advisable to remove any accumulated dust with a low power vacuum cleaner.

Note: Installation and Maintenance of the equipment must be as directed in the instructions provided with the unit.

Warranty

The 5 year warranty starts from the day of delivery and includes parts and labour for the first year.

The remaining 4 years covers replacement parts only.

The warranty is subject to the equipment having been installed and maintained in full compliance with these instructions.

Service Enquiries

Nuaire can assist you in all aspects of service. Our Technical Support department will be happy to provide any assistance required.

Telephone 029 2085 8400

Fax 029 2085 8444

Technical or commercial considerations may, from time to time, make it necessary to alter the design, performance and dimensions of equipment and the right is reserved to make such changes without prior notice.