

## QTE QUIETWIN Direct Drive Twinfans Single phase, external / internal

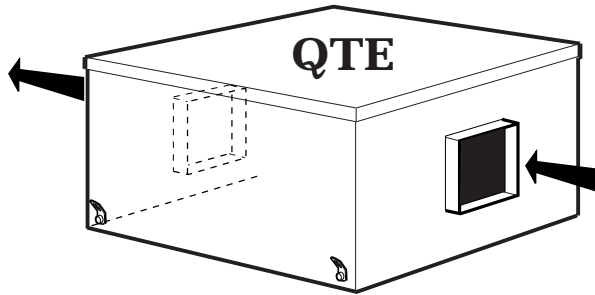

Fig. 1. General view of a QTE External, In line, Duct unit.

### Introduction

The NuAire QUIETWIN Twinfan Direct Drive range comprises 4 basic designs with duties up to a maximum of 1.53m<sup>3</sup>/s. The 4 models are coded as follows:

**QTI** (Internal Duct Mounted) in line unit.

**QTE** (External / internal Duct Mounted) in line unit)

**QTR** (Roof Mounted, end inlet) side discharge unit.

**QTRB** (Roof Mounted bottom inlet) side discharge unit.

QTE units are rectangular in section and have square rigid spigots at each end (Code QTES). Circular spigots can be specified if preferred (Code QTEC).

The casing is manufactured from heavy gauge natural aluminium alloy. The internal inlet chamber surfaces are acoustically lined

A full size access panel fitted to the top of the unit which is fully detachable for inspection purposes.

The units incorporate two independent motors with high efficiency, forward curved centrifugal impellers running in metal scrolls. The motors are manufactured to BS 5000 and are suitable for single phase supply. Airflow and failure monitors are standard as is Class B insulation. Suitable for operation in ambient temperatures up to 40°C.

### ISOLATION

**Note that the unit must be provided with a means of isolation (by others) for maintenance purposes etc.**

**A suitable isolator can be supplied by NuAire on request as a separate item.**

### Coding

**QTE**= Quietwin, duct mounted, external / internal use.

**C** = Circular spigots.

**S** = Square spigots.

**1** = Fan performance curve number.

**S** = Smart integral fan control.

**M** = Microsave integral fan control.

**C** = Mains fan control.

**QTEC 1 S** = Quietwin, duct mounted for external use, circular spigots and Smart integral control.

### Contents

Contents	Page
Introduction	1
Installation	1
Handling	1
Dimensions	2
Motor information	2
Roof mounting details	3
Control option'S'	5
Commissioning	7
Control option'M'	9
Control option'C'	10
Adding a speed control	11
Maintenance	12
Certification	13

### Controls

Various methods of control are available and these include

- SMART (S) control.
- MICROSAVE (M) control.
- MAINS (C) control.

**Note: When a Microsave unit is supplied, the User Control is included inside the fan case for delivery.**

Details of control installations are shown in the relevant control leaflets which are supplied with each control.

### Handling

Always handle the units carefully to avoid damage and distortion. If mechanical aids are used to lift the unit, spreaders should be employed and positioned so as to prevent the slings, webbing etc. making contact with the casing.

### Installation

Quietwin QTE units are suitable for internal or external use and can be installed at any angle upto 60°. However, **on asloping roof the unit must be blowing upwards** toward the roof ridge to ensure correct backdraughtshutter operation

**Units should always be positioned with sufficient space to allow removal of the access cover and subsequent removal of fan and motor assemblies etc.**

Whether internally or externally mounted, the method of fixing to the roof is the responsibility of the installer.

QTE units have a bottom skirt to allow for fixing directly onto a suitably sized curb or builders upstand. NuAire can supply a matching prefabricated curb for these units. Details of curbs and dimensions for a suitable external concrete upstand are shown on page 3.

Ductwork connections must be airtight to prevent any loss of performance.

QTE fans have an internal connection box (or control module on 'S' control options) requiring connection to the mains supply on installation. It is the installers responsibility to drill the case to provide access for the electrical cables. Care should be taken not to damage internal components and the cable entry should be properly sealed.

## NOTE: Smart 'S' control options

On these smart control units, a commissioning box is fitted on casing side to allow the installer/user to set up and monitor the system status without having to gain access to the fans internal control module.

Other control options i.e. Microsave (M) and Mains (C) are remote mounted control boxes which would normally be located inside the building.

## Dimensions

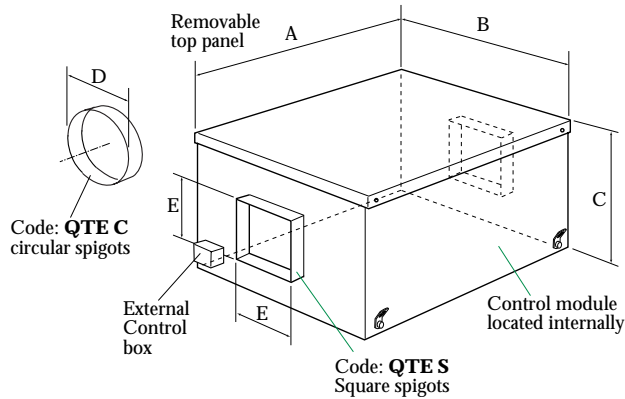

Fig. 2. Dimensions QTE External Duct model

Table 1. QTE dimensions

Dimensions (mm)				QTEC	QTES	Weight
Unit	A	B	C	D dia	ExE	(kg)
QTE 1	705	505	355	125	114	22
QTE 2	875	720	400	200	178	35
QTE 3	970	720	485	200	178	5
QTE 4	1165	980	575	250	216	72
QTE 5	1165	980	575	400	305	75
QTE 6	1165	980	575	400	305	86
QTE 7	1495	1125	710	500	457	162

## Electrical Details (See table 2).

Because the run and start currents depend upon the duty and associated ductwork of an individual unit, the values quoted in the table are nominal.

Run currents will be exceeded if the unit is operated with its cover removed. It is therefore recommended that the unit is not run for prolonged periods in this condition.

## Electrical Note

(See electrical wiring diagrams at the rear of this leaflet).

If a NuAire control has been supplied, wire the control to the Fan unit and also to the mains supply.

## Motor Electrical Information

Unit Code	Speed rpm	Input Power (watts)	Electrical 1 Phase (230V) ONLY (nominal)	
			flc (amps)	sc (amps)
QTE 1	2040	86	0.65	1.3
QTE 2	1320	104	0.56	1.5
QTE 3	1260	230	1.6	4.7
QTE 4	1140	370	1.6	4.7
QTE 5	1110	660	2.95	10
QTE 6	1272	1110	4.84	18
QTE 7	960	1406	6.3	50

Table 2. Motor details

## Testing after Installation

Ensure that the Fan unit and Control and particular control ancillaries if specified eg PIR, Run/Fail indicators, timeclock etc. are fitted.

Switch on and check that the fan unit runs satisfactorily.

Using your chosen control, switch over to the standby fan by means of the control's fan selection switch. On 'S' control versions, switch over to the standby fan by means of the fan selection switch (situated in the commissioning box on side of the case, see fig. 6 & 7). Check that the change-over occurs.

Switch off. If a Run-on Timer is fitted, check that the fan continues to run.

(Note the other control options have remote panels to access fan functions).

Time the run-on period, which is adjustable between 5 and 60 minutes nominal. (Timer controls are set at the works to the shortest period).

For speed controls follow the installation set-up procedure provided with the control.

## Prefabricated Curb

Manufactured in aluminium alloy these curbs will reduce design work and guarantee correct unit mounting when on site.

Note: Upper faces of curb are fitted with robust sealing strip.

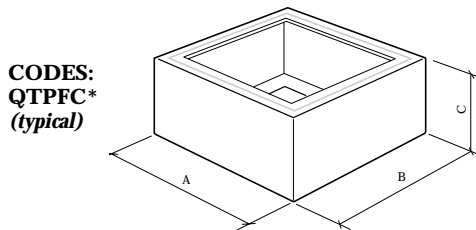

Figure 3. Prefabricated curb details

Table 3.

Dimensions (mm)				
Unit Code	Prefab Code	A	B	C
QTE 1	QTPFC1	635	435	250
QTE 2	QTPFC2	805	650	250
QTE 3	QTPFC3	900	650	250
QTE 4	QTPFC4	1095	910	250
QTE 5	QTPFC4	1095	910	250
QTE 6	QTPFC4	1095	910	250
QTE 7	QTPFC5	1425	1045	250

## Typical roof upstand dimensions

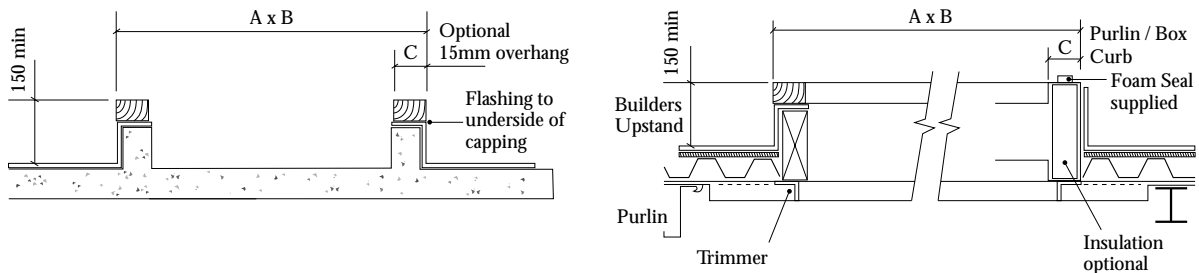

Figure 4. Roof upstand details

Table 4.

Unit Code	Dimensions (mm)		
	A	B	C
QTE 1	665	465	50
QTE 2	835	680	50
QTE 3	9205	680	50
QTE 4	1120	940	75
QTE 5	1120	940	75
QTE 6	1120	940	75
QTE 7	1445	1080	75

**NOTE:**  
These Builders Work Details are for guidance only.

### Casing skirt depth

The fan casings have an inside skirt depth of 60mm or, in the case of the largest size units only, 50mm.

It is recommended that the units are mounted upon a suitable curb or upstand which has a minimum height of 150mm (inclusive of the timber capping if applicable, see curb dimensions).

This mounting height provides adequate distance to avoid any standing water on the roof being drawn into the fan (this can occur on bottom inlet installations (QTR) if a unit is not properly installed and an air leak in the unit / ductwork joint is pulling air over the curb.

The recommended height will also ensure that the unit does not 'stand' on its skirt edge. (QTE & QTR units).

## QTE Direct Drive, Control Option 1 Smart (S)

Smart Controls provide Automatic, Energy Efficient Ventilation with or without 'Plug-in' Sensors & Controls. Systems can be simple or comprehensive to your specific application.

The illustration shows a typical system and the way that the various options are used and connected within the system

### COMPREHENSIVE SMART SYSTEM

**Note: The drawing is for general information purposes only and does not represent a specific system**

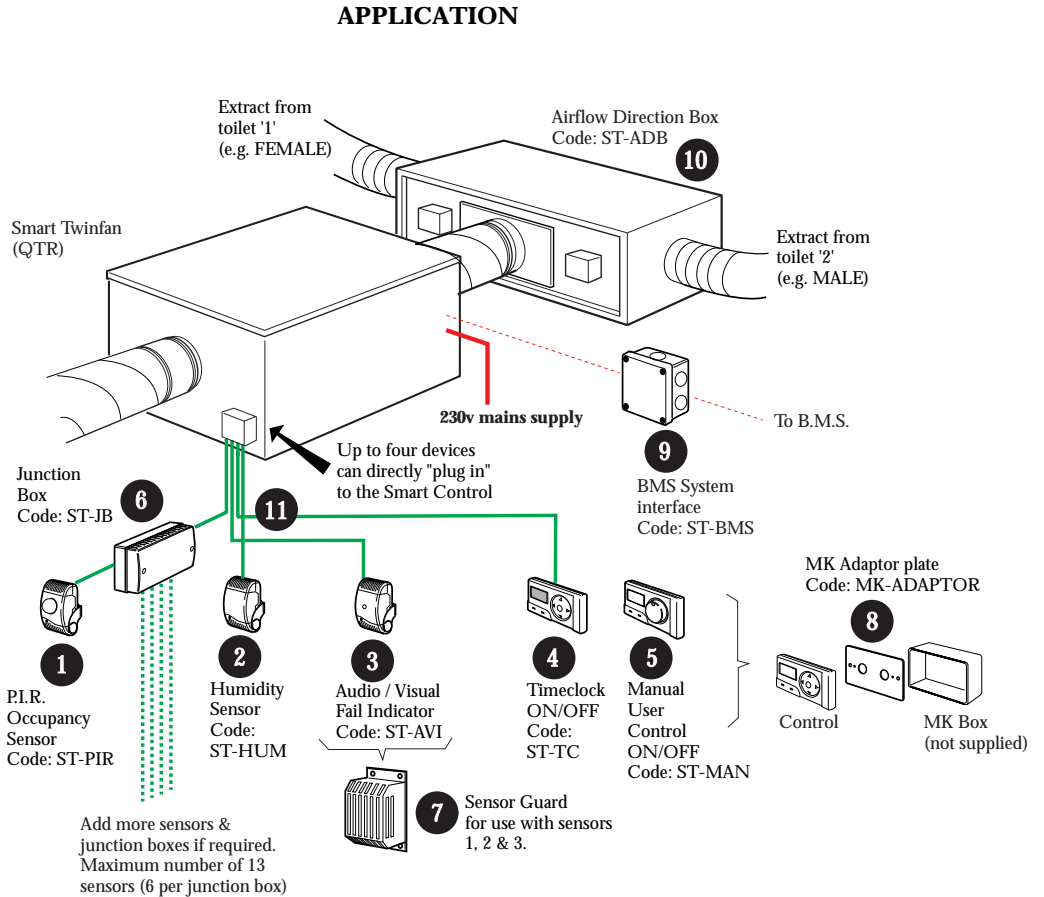

Fig. 5. Quietwin system showing additional options

### BASIC SMART SYSTEM

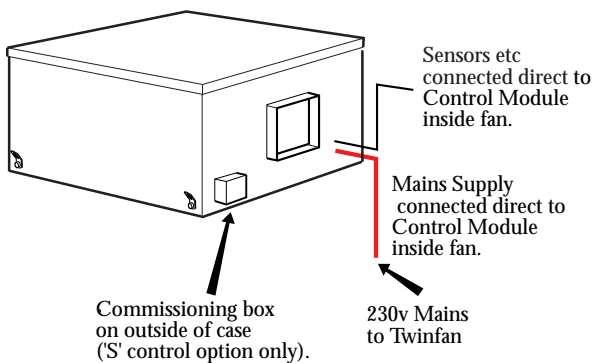

Fig. 6. QTE with Option 1 'S' Smart Control direct to Twinfan.

### Options

List of available sensors, user controls and ancillaries for "S" option users with a reference to corresponding information leaflets

- 1 PIR Occupancy sensor, code: ST-PIR (Leaflet No: 670864)
- 2 Humidity sensor, code: ST-HUM (Leaflet No: 670865)
- 3 Audio / visual fail indicator, code: ST-AVI (Leaflet No: 670877)
- 4 Timeclock on / off, code: ST-TC (Leaflet No: 670866)
- 5 Manual user control, code ST-MAN (Leaflet No: refer to Nuaire)
- 6 Junction Box, code: ST-JB (Leaflet No: refer to Nuaire)
- 7 Sensor guard, code: SENSOR GUARD
- 8 MK Adaptor plate, code: MK ADAPTOR (Leaflet No: refer to Nuaire)
- 9 BMS Interface, code: ST-BMS (Leaflet No: 6708697)
- 10 Airflow direction box, code: ST-ADB (Leaflet No: refer to Nuaire)
- 11 Low voltage comms cable 10m length (supplied with controls)

## QTE Direct Drive, Control Option 1 Smart (S) continued.

### Connecting unit to the mains 230v supply

The mains supply must be routed through the side of the fan case. This is the responsibility of the installer and care should be taken not to accidentally damage any internal components. Connect to the terminals on the Control Module labelled MAINS. (See fig 8 below). Seal the casing cable entry to avoid loss of performance.

For commissioning etc, a box containing basic status and speed control is provided on the outside of the case (see fig 7 & 10).

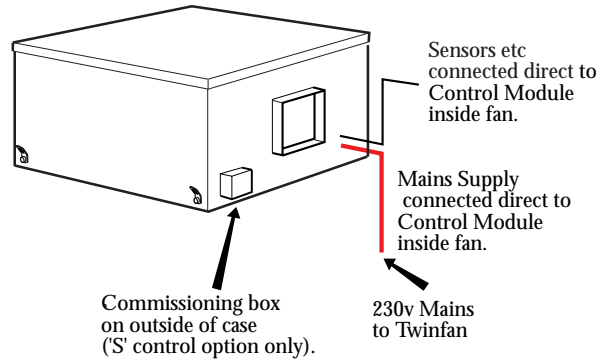

Fig 7. Single Phase Quietwin using Smart (S) Control

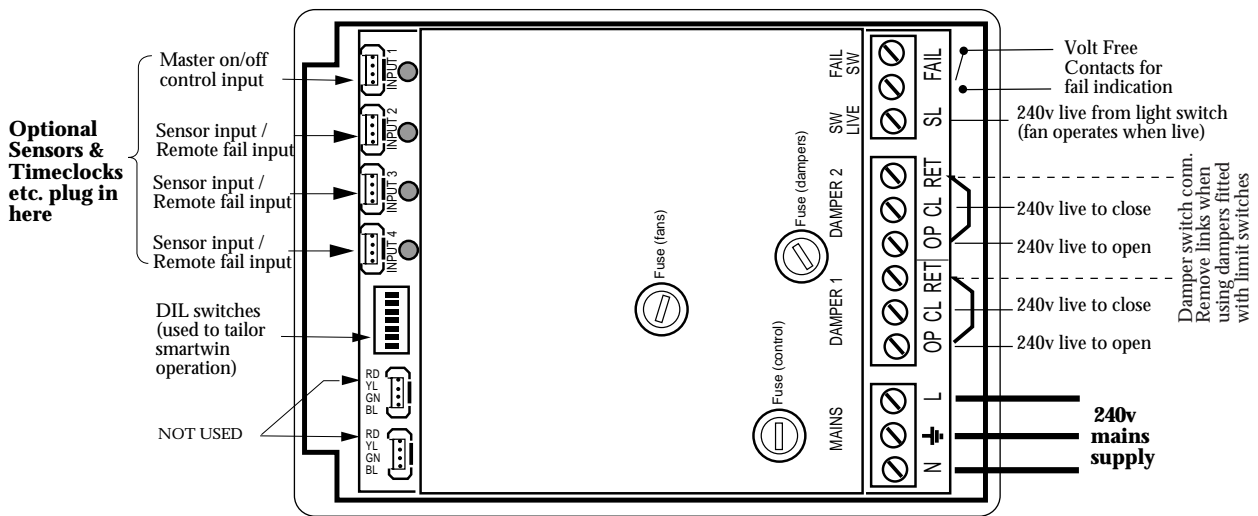

Fig 8. Control module connections inside fan.

## Control Module Connections The inputs and their uses (see fig 8)

### SENSOR INPUT 1:

This is the Master on/off control input and is usually 'linked out' with a special plug unless:

A Timeclock can be connected into this input e.g. ST-TC During ON times the unit is allowed to operate.

During OFF times the unit is off- zero duty.

*Note: The ST-TC Timeclock must always be plugged into the fan mounted control module NOT into a ST-JB junction box.*

### SENSOR INPUTS 2, 3 & 4

Any sensor can be connected to these inputs to allow activation of the unit. If any of these inputs is activated, the unit will run at the maximum set duty. These sensors include ST-PIR, & ST-HUM.

*Note: Additional sensors may be added by using an ST-JB Junction Box.*

### SWITCH LIVE terminals

This acts just like the sensor inputs 2,3,4. If 230v ac is detected on the SW - Live terminals, the unit will run at the max. set duty.

### DAMPER terminals (2 sets)

Details of electrical connections on the Airflow Direction Box and wiring to the control module are shown also on page 6.

When the fan is running at full duty, both these damper connections will be activated. i.e. power will be available on the OP terminals of the damper connections. The fan will not go to full duty until the RET terminals have 230v ac (Limit Switch).

### FAILURE RELAY

This relay is normally closed when there are no faults. When faults occur this relay will open and break the circuit. This method of operation allows all types of failure to be detected for example 'Power failed', 'Fan/s fail.

This connection is a volt free switch, it is rated at 5A (230v) and fused for protection.

- NO FAULT: The volt free switch is closed i.e. the two terminals are connected.
- FAN FAULT: The volt free switch is opened. i.e. the two terminals are disconnected.

## QTE Direct Drive, Control Option 1. Smart (S) continued

### DIL switch settings

Operation can be individually tailored to suit your own particular application. The DIL setting switches are located on the left of the panel as shown in fig. 8.

A label is attached to the control module cover inside the fan which details the various switch functions. Refer also to switch settings shown below.

#### DEFAULT MODE:

The fan runs in trickle mode until the toilet is occupied

**Switch 1 & Switch 2** .....Trickle mode and rate

**Switch 3** .....Airflow Direction Box fitted (ST-ADB)  
 ON = Airflow Direction Box fitted (ST-ADB)  
 OFF = No Airflow Direction Box fitted

### DIL Switch Settings

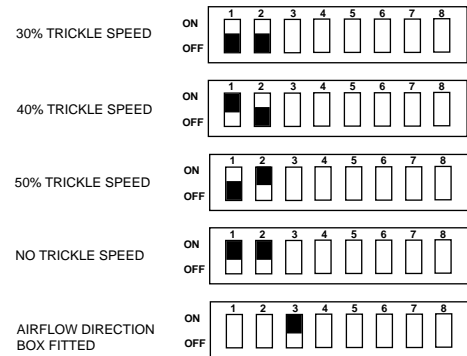

### Split duty via Damper Box.

#### (AIRFLOW DIRECTION BOX)

A typical application of the damper is illustrated in fig 5.

### Wiring Connections from QTE to optional Airflow Direction Box. Code: ST-ADB

#### CONTROL MODULE CONNECTIONS

##### Sensor/s are connected to sensor input 2

When the sensor is activated, the duty fan will run at 50% of the max. set duty and damper relay 1 will be activated.

##### Sensor/s are connected to sensor input 3

When the sensor is activated, the duty fan will run at 50% of the max. set duty and damper relay 2 will be activated. If both sensor input 2 and sensor input 3 are activated together, the fan will run on the maximum set duty.

Also, if sensor input 4 (or SL) is activated when a damper box / split duty system is being used, both the damper relays will operate and the fan will run at full duty.

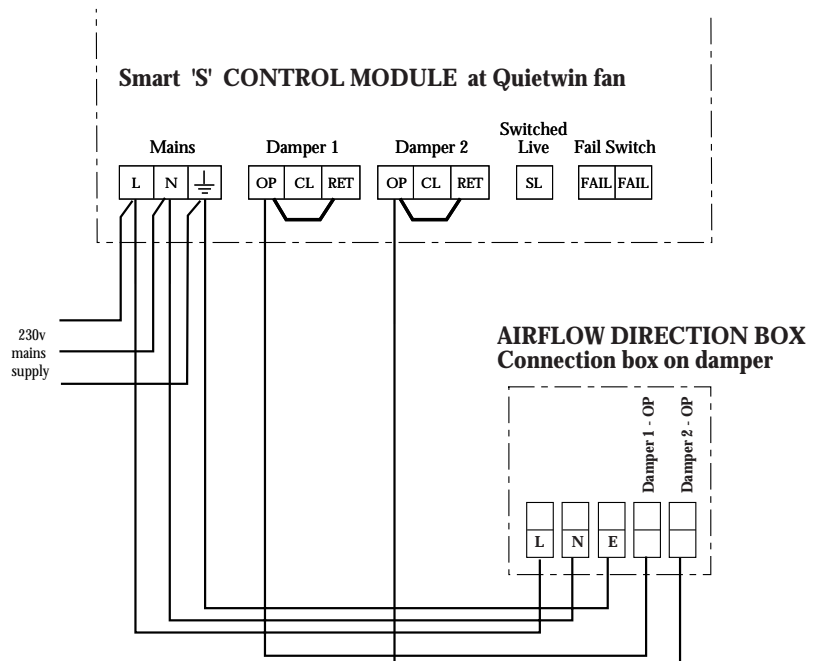

Fig 9 Airflow direction Box terminal connections

## QTE Direct Drive, Control Option 1. Smart (S) continued.

### Using the Step button

Refer to the label on the control panel for additional guidance. Pressing the step button will sequence through the options and change the modes as follows:

1. FAN 1 in manual mode (used for commissioning)
2. FAN 2 in manual mode (used for commissioning)
3. SYSTEM OFF
4. SYSTEM IN AUTOMATIC (normal selection)

To clear a fail, press the STEP button until the fail has cleared.

**IMPORTANT After commissioning, press the STEP button through until AUTO is illuminated. System is now in automatic mode.**

Note Cover must be properly replaced when commissioning has been completed.

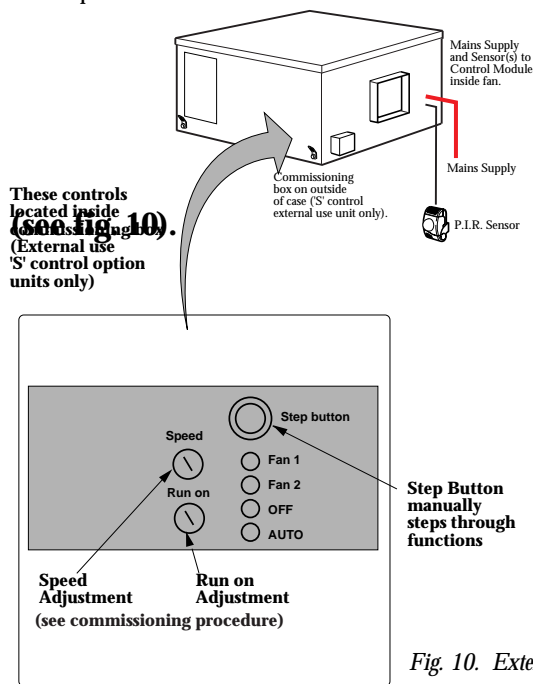

Fig. 10. Exterior commissioning control box panel.

### COMMISSIONING

#### Adjusting the air volume flow rate.

1. The commissioning controls are located in a small exterior case mounted control box. (See fig.10). Remove the box cover. The controls available on this panel include:  
**The Step (sequencing) button**  
**Speed Adjustment**  
**Run on Timer adjustment**  
**LED status indicator lights**
2. Switch on the supply to the QTI Quietwin fan.
3. A 'Self Test' will automatically begin which runs each fan for a few seconds. Wait approximately 60 seconds for the system to complete its 'Self Test'
4. Press the step sequencing button several times until **only** the 'FAN 1' light is illuminated and the 'AUTO' light is off. (See detail of control panel Fig. 10).
5. Connect a manometer across the tappings provided on the outside of the fan casing. Reading the manometer and using the graph, determine the airflow. (See 'Using the Graphs for Commissioning').  
 The fan is factory set at full speed. Using the rotary graduated speed control, reduce the speed to the desired setting (may require a screwdriver).  
**NOTE:** allow 30 seconds for the fan to reach the set speed.
6. **Set the Run on timer control.** (Adjustable 5-60 min). (See detail of control panel Fig. 10).
7. **Finally, press the STEP button through until AUTO is illuminated. The system is now in automatic mode.**

**COMMISSIONING IS NOW COMPLETE.**

### Commissioning using the graphs

The graphs are designed to assist you in establishing an AIR VOLUME FLOW RATE for your fan installation.

The curves shown indicate performance at 100%, 75% and 50%. Assuming that the ventilation system is installed and the fan is connected to all ductwork. Connect a manometer across the tappings provided on the outside of the fan unit casing.

The fan is factory set for full speed. With the fan operating at this full speed (100%) take a pressure reading in Pa from the manometer. Refer to the relevant graph for your size of unit and with your Pa figure, read across the graph to where the line intersects the 100% curve. Drop a line vertically down from this point and the air volume flow is indicated on the base line of the graph. QTR Quietwin graphs are shown on the following pages

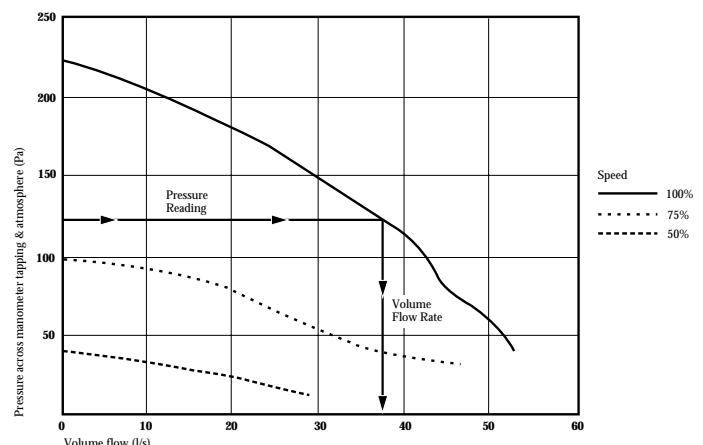

## QTE Direct Drive, Control Option 1. Smart (S) continued.

### Commissioning Graphs QTE Quietwins (continued)

To be used in conjunction with the commissioning procedure as detailed on page 5. The QTE Quietwin is offered in 7 performance curve sizes numbered 1-7.

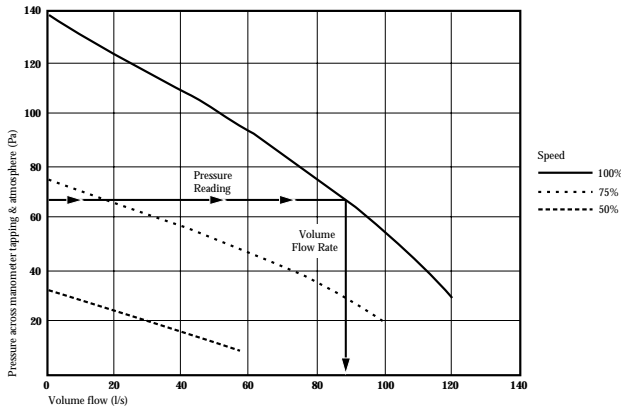

**QTE Quietwins Size 2**

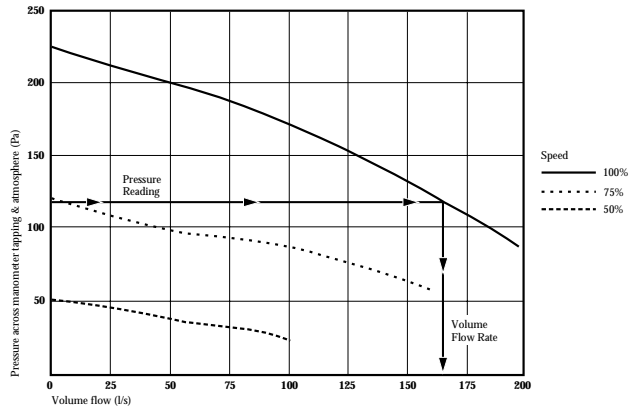

**QTE Quietwins Size 3**

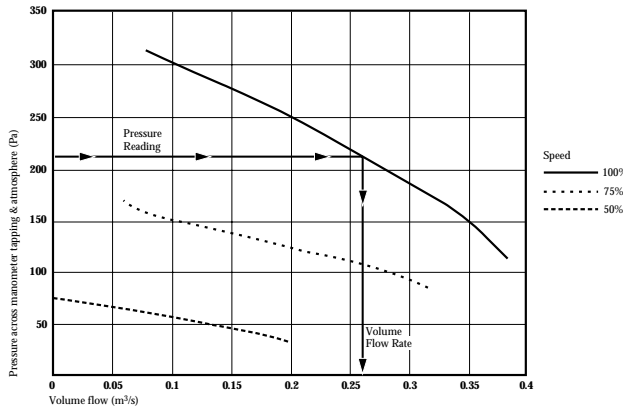

**QTE Quietwins Size 4**

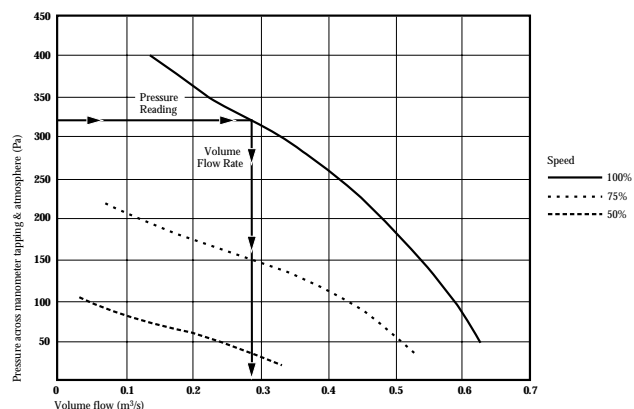

**QTE Quietwins Size 5**

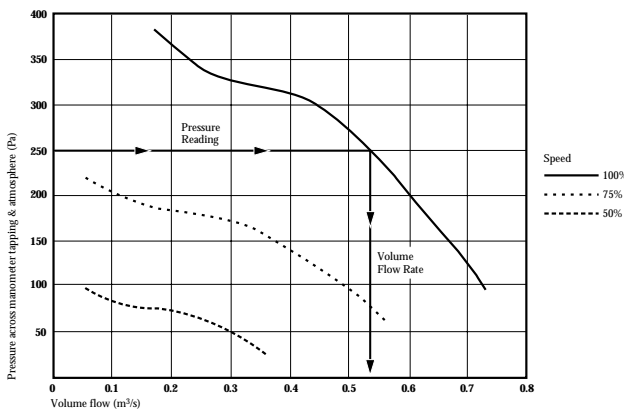

**QTE Quietwins Size 6**

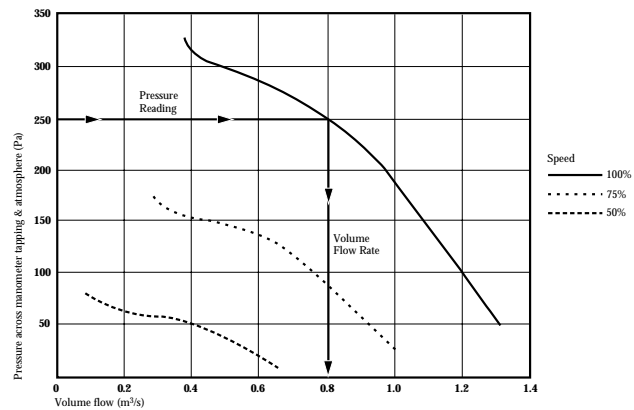

**QTE Quietwins Size 7**



## QTE Direct Drive, Control Option 2. Microsave (M)

### Wiring Connections Microsave Control 'M'

**Notes:**

System over Microsave User Control  
system Microsave

- Terminals are provided within the Control Box for **Building Management System (Building Management)** (on/off and Fan speed adjustment, requires the connection of an additional Control Leaflet No. 670915).
- Note that when a Microsave controlled unit is supplied the User Control is included inside the fan unit for delivery to site.** Take care not to misplace the item before installation.

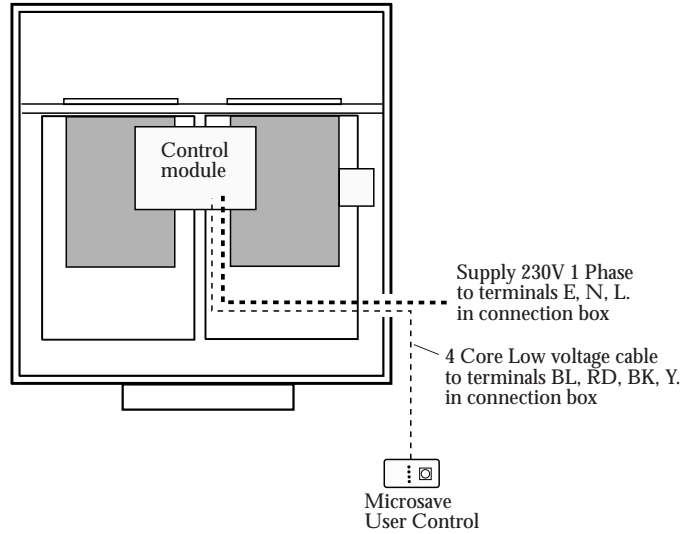
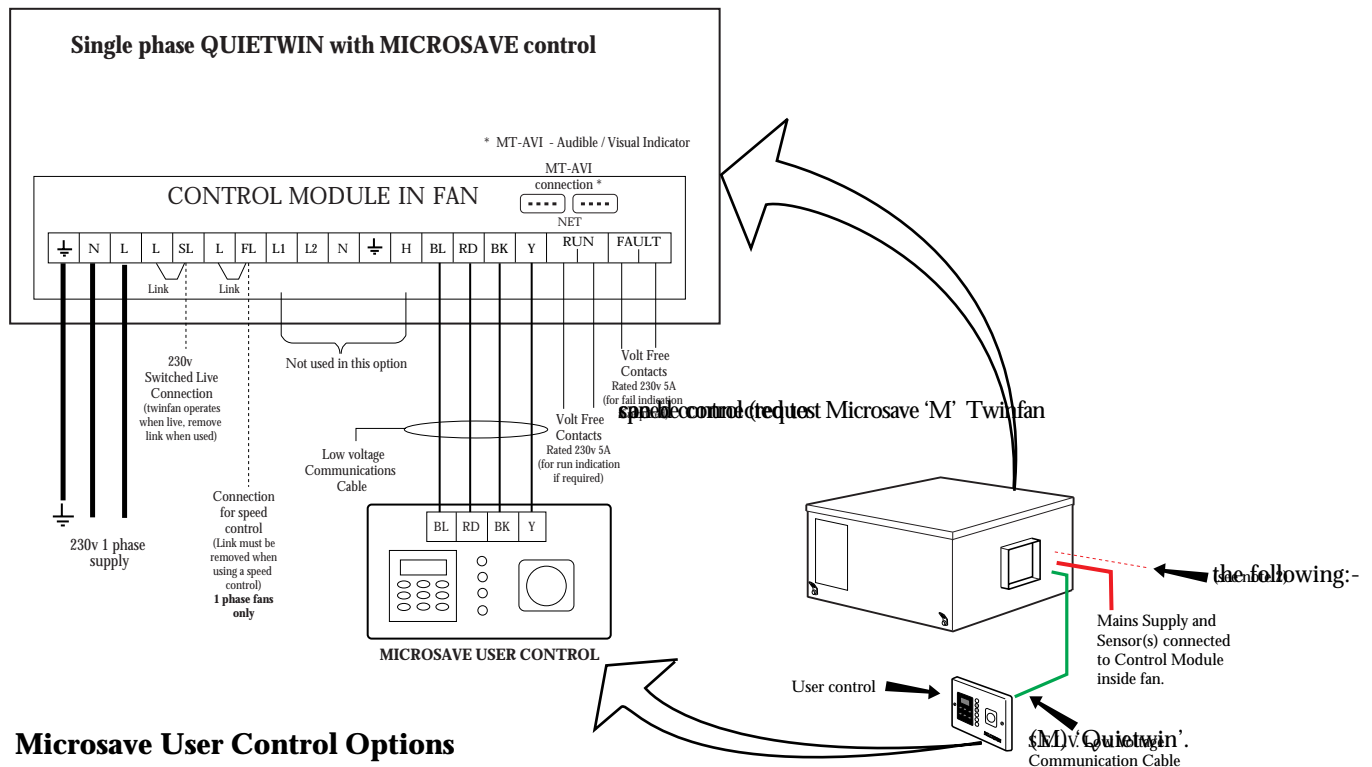

Fig. 11. Single Phase Quietwin using Microsave (M) Control.



### Microsave User Control Options

Code	Description
MT-A	Manual duty sharing
MT-M	Manual duty sharing with timeclock
MT-ATC	Auto duty sharing with timeclock
MT-MTC	Manual duty sharing with timeclock

**NOTE**  
See relevant Installation & Maintenance instructions for your chosen NuAire Control.  
**Microsave Twinfan Control:**  
Leaflet No: 670915  
Copies are available from the NuAire Technical Library (01222 858231)

## QTE Direct Drive, Control Options. Option 3 Mains (C)

### Wiring Diagrams Mains Control 'C'

**Notes:**

1. Only one Mains User Control can be connected to each Mains 'C' in this leaflet.
2. Mains power can be connected to the Mains Control or the 'Quietwin'.
3. Terminals are provided within the Mains Control for the following:-
  - BMS (Building Management System) override control (on/off and system status).
  - Fan speed adjustment, requires the connection of an additional speed control Control Leaflet No. 670912).

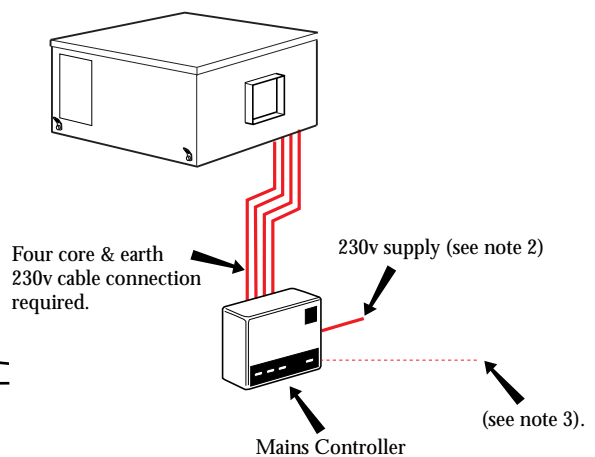
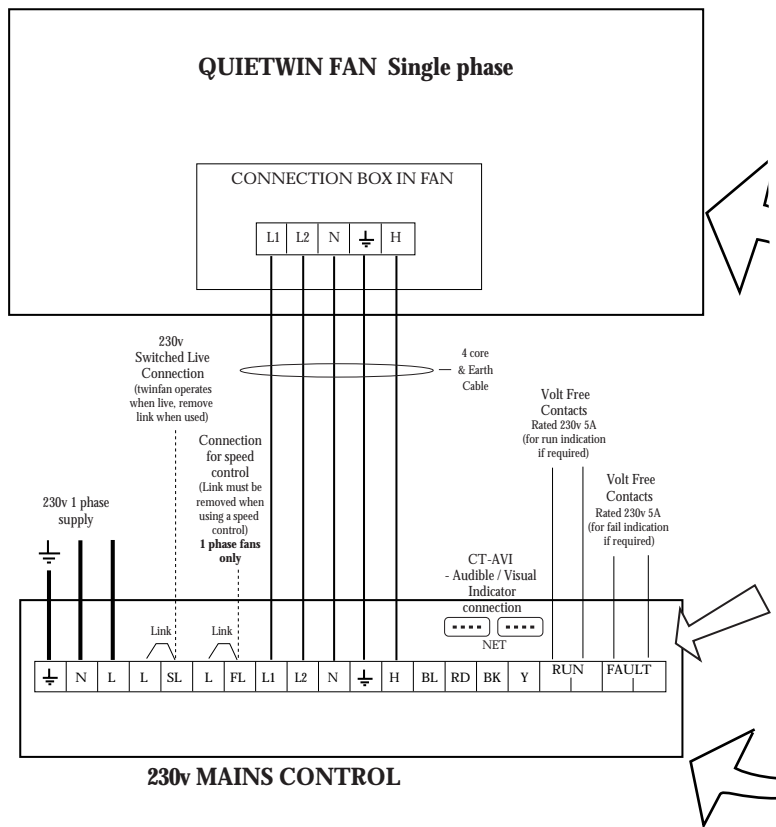
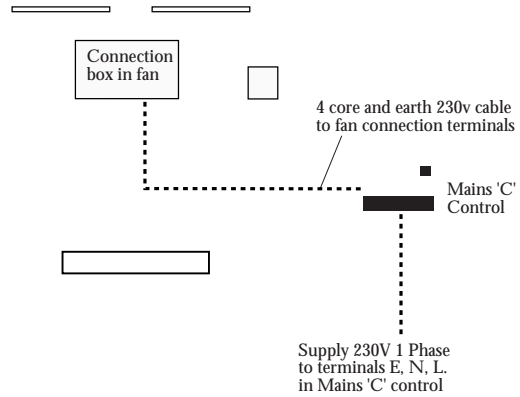

## QTE Direct Drive, Speed control for Microsave (M) and Mains (C) unit options

### Using a Speed Control with a Quietwin

#### (SINGLE PHASE TWINFANS ONLY)

When using a Single Phase Twinfan it is possible to connect a Speed Control to modify the output of the fan when commissioning the system. Details of suitable Speed Controls are shown below.

When using a speed control with a single phase Twinfan, the factory link between terminals L and FL must be removed. The output of the Speed control should then be connected to the FL terminal (See drawing below).

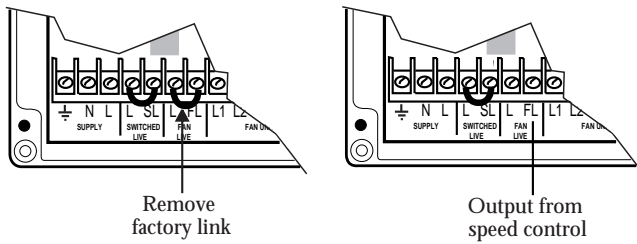

Table 5

### Speed Control selection

Fan Unit Code	Speed Control Code
QTE 1 - 5	SCELEC1/1
QTE 6	SCELEC2/1
QTE 7	SCELEC3/1

## Maintenance (General, all Twinfans)

### ISOLATION

**BEFORE COMMENCING WORK MAKE SURE THAT THE UNIT AND NUAIRE CONTROL, IF FITTED, ARE ELECTRICALLY ISOLATED FROM THE MAINS SUPPLY.**

### Maintenance Intervals

The first maintenance should be carried out three months after commissioning and thereafter at twelve monthly intervals. These intervals may need to be shortened if the unit is operating in adverse environmental conditions, or in heavily polluted air.

### Lubrication

Motors are fitted with sealed for life bearings and therefore require no further lubrication.

### General Cleaning and Inspection

Clean and inspect the exterior of the fan unit and associated controls etc.

Remove the access panel from the fan unit. Inspect and, if necessary, clean the fan and motor assemblies and the interior of the case. If the unit is heavily soiled it may be more convenient to remove the fan / motor assemblies.

Check that the shutters are free to move smoothly and that they seal the appropriate fan outlet effectively.

Clean and inspect each fan and motor assembly as follows; taking care not to damage, distort or disturb the balance of the impeller.

- Lightly brush away dirt and dust, paying particular attention to any build up at the motor ventilating slots. If necessary, carefully remove with a blade or scraper.
- Stubborn dirt at the impeller may be carefully removed with a stiff nylon brush.
- Check all parts for security and general condition. Check that the impeller rotates freely.

Refit the assemblies to the unit (see Replacement of Parts) then replace the access covers

If NuAire controls and or remote indicators are fitted, remove the covers and carefully clean out the interiors as necessary. Check for damage.

Check security of components. Refit the access covers.

## Service

As a manufacturer NuAire can provide you with factory trained Service Engineers.

Our Engineers are supported by a comprehensive range of spare parts 'off the shelf'.

If you are an industrial or commercial user, you may be interested in details of NuAire's regular maintenance Service Contracts. This is a worthwhile service that helps you get the most from our products.

Our Service Department will be happy to give you more information.

Please telephone: **029 2085 8271**

## Replacement of Parts

The only item of the fan units unit likely to require replacement are the fan/motor assemblies due to a failed motor or damaged impeller. In either eventuality the complete fan/motor assembly must be removed from the unit case.

### NOTE:

**BEFORE COMMENCING WORK, ELECTRICALLY ISOLATE THE FAN UNIT AND / OR THE ASSOCIATED NUAIRE CONTROL, IF FITTED, FROM THE MAINS SUPPLY.**

Remove the access cover. Disconnect the wiring on the particular fan/motor assembly to be removed. Support the weight of the fan/motor assembly and remove the mounting screws and washers. Lift the assembly out of the case.

After replacing the faulty item, refit the fan/motor assembly and re-connect the incoming wiring to the fan mounted connection box. Replace the access cover.

## Schedule of Parts

When ordering spares please quote the serial number of the unit together with the part number if. If the part number is not known please give a full description of the part required. The serial number will be found on the identification plate attached to the unit casing

Table 6 Spares listing

Unit code	Blower assembly c/w motor.
QTE 1	772031
QTE 2	772032
QTE 3	772033
QTE 4	772034
QTE 5	772035
QTE 6	772036
QTE 7	772037

## Controls Application Service (CAS)

A team of Engineers and technicians is available to provide pre and post order support.

We are on hand to provide help and advice from the most basic use of any NuAire equipment to the more complex applications, maximising on the versatility of our SMART and NetLink control products.

**Telephone: 029 2085 8585**

**Facsimile: 029 2085 8586**



*We declare that the machine named below  
conforms to the requirements of EC Council Directives  
relating to Electromagnetic Compatibility and  
Safety of Electrical Equipment.*

---

<b>Designation of machinery :-</b>	QUIETWIN DIRECT DRIVE
<b>Machinery Types :-</b>	QTE
<b>Relevant EC Council Directives :-</b>	89/336/EEC, 92/31/EEC (EMC) 73/23/EEC, 93/68/EEC (Low Voltage Directive)
<b>Applied Harmonised Standards :-</b>	E50081-1, EN50082-1, EN60204-1 EN60335-2-80
<b>Basis of Self Attestation :-</b>	Quality Assurance to BS EN ISO 9001 BSI Registered Firm Certificate No. FM 149

---

**Signature of manufacture representatives :-**

	<b>Name:</b>	<b>Position:</b>	<b>Date:</b>
1)	 C. Biggs	Technical Director	2. 11. 99
2)	 W. Glover	Manufacturing Director	2. 11. 99

## **DECLARATION OF INCORPORATION & INFORMATION FOR SAFE INSTALLATION, OPERATION & MAINTENANCE**

NOVEMBER 1999

*We declare that the machinery named below is intended to be assembled with other components to constitute a system of machinery.*



*The machinery shall not be put into service until the system has been declared to be in conformity with the provisions of the EC Council Machinery Directive.*

---

<b>Designation of machinery :-</b>	QUIETWIN DIRECT DRIVE
<b>Machinery Types :-</b>	QTE
<b>Relevant EC Council Directives :-</b>	89/392/EEC (Machinery Directive) 93/44/EEC (Amendment to the Machinery Directive)
<b>Applied Harmonised Standards :-</b>	EN292-1, EN292-2, EN294, EN29001
<b>Applied National Standards :-</b>	BS848 Parts One, Two and Five

---

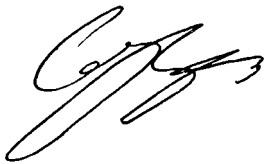
### **Signature of manufacture representatives :-**

	<b>Name:</b>	<b>Position:</b>	<b>Date:</b>
1)	 C. Biggs	Technical Director	3.11.99
2)	 W. Glover	Manufacturing Director	3.11.99

# **INFORMATION FOR SAFE INSTALLATION, OPERATION AND MAINTENANCE OF NUAIRE VENTILATION EQUIPMENT**

**To comply with EC Council Directives 89/392/EEC Machinery Directive & 93/44/EEC Amendment to the Machinery Directive.**

*To be read in conjunction with the relevant Product Documentation (see 2.1)*

## **1.0 GENERAL**

- 1.1 The equipment referred to in this **Declaration of Incorporation** is supplied by NuAire to be assembled into a ventilation system which may or may not include additional components.  
The entire system must be considered for safety purposes and it is the responsibility of the installer to ensure that all of the equipment is installed in compliance with the manufacturers recommendations and with due regard to current legislation and codes of practice.

## **2.0 INFORMATION SUPPLIED WITH THE EQUIPMENT**

- 2.1 Each item of equipment is supplied with a set of documentation which provides the information required for the safe installation and maintenance of the equipment. This may be in the form of a Data sheet and/or Installation and Maintenance instruction.
- 2.2 Each unit has a rating plate attached to its outer casing. The rating plate provides essential data relating to the equipment such as serial number, unit code and electrical data. Any further data that may be required will be found in the documentation. If any item is unclear or more information is required, please contact NuAire.
- 2.3 Where warning labels or notices are attached to the unit the instructions given must be adhered to.

## **3.0 TRANSPORTATION, HANDLING AND STORAGE**

- 3.1 Care must be taken at all times to prevent damage to the equipment. Note in particular that shock to the unit may result in the balance of the impeller being affected.
- 3.2 When handling the equipment, care should be taken with corners and edges and that the weight distribution within the unit is considered. Lifting gear such as slings or ropes must be arranged so as not to bear on the casing.
- 3.3 Equipment stored on site prior to installation should be protected from the weather and steps taken to prevent ingress of contaminants.

## **4.0 OPERATIONAL LIMITS**

- 4.1 It is important that the specified operational limits for the equipment are adhered to *e.g. operational air temperature, air borne contaminants and unit orientation.*
- 4.2 Where installation accessories are supplied with the specified equipment eg. wall mounting brackets. They are to be used to support the equipment only. Other system components must have separate provision for support.
- 4.3 Flanges and connection spigots are provided for the purpose of joining to ductwork systems. They must not be used to support the ductwork.

## **5.0 INSTALLATION REQUIREMENTS**

*In addition to the particular requirements given for the individual product, the following general requirements should be noted.*

- 5.1 Where access to any part of equipment which **moves**, or can become **electrically live** are not prevented by the equipment panels or by fixed installation detail (eg ducting), then guarding to the appropriate standard must be fitted.
- 5.2 The electrical installation of the equipment must comply with the requirements of the relevant local electrical safety regulations.

## **6.0 COMMISSIONING REQUIREMENTS**

- 6.1 General pre-commissioning checks relevant to safe operation consist of the following -  
Ensure that no foreign bodies are present within the fan or casing  
Check electrical safety. *e.g. Insulation and earthing.*  
Check guarding of system.  
Check operation of Isolators/Controls.  
Check fastenings for security.
- 6.2 Other commissioning requirements are given in the relevant product documentation.

## **7.0 OPERATIONAL REQUIREMENTS**

- 7.1 Equipment access panels must be in place at all times during operation of the unit, and must be secured with the original fastenings.
- 7.2 If failure of the equipment occurs or is suspected then it should be taken out of service until a competent person can effect repair or examination. (Note that certain ranges of equipment are designed to detect and compensate for fan failure).

## **8.0 MAINTENANCE REQUIREMENTS**

- 8.1 Specific maintenance requirements are given in the relevant product documentation.
- 8.2 It is important that the correct tools are used for the various tasks required.
- 8.3 If the access panels are to be removed for any reason the electrical supply to the unit must be isolated.
- 8.4 A minimum period of two minutes should be allowed after electrical disconnection before access panels are removed. This will allow the impeller to come to rest.  
NB: *Care should still be taken however since airflow generated at some other point in the system can cause the impeller to "windmill" even when power is not present.*
- 8.5 Care should be taken when removing and storing access panels in windy conditions.

Please fill in your warranty form and return to NuAire Service Department at the address below.

## NuAire Quietwin - Warranty Application

### Installation Contractor:-

Project Name: .....

Company Name: .....

Site Address: .....

Company Address: .....

.....

.....

.....

CDM.....

..... Postcode: .....

..... Postcode: .....

Arc No: .....

Telephone No: .....

Unit Code: .....

Fax No: .....

Unit Serial No: .....

Date of Installation: .....

**NB. All items must be completed for the warranty to be valid**

Signed: ..... Date: .....

Print name: .....

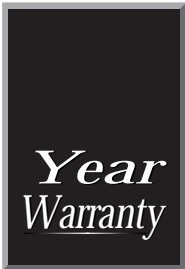

The 12 year warranty starts from the date of delivery and includes parts and labour for the first year. The labour element is subject to full, free and safe access to the as recommended by the regulations. The remaining 11 years covers replacement parts only.

*Technical or commercial considerations may, from time to time, make it necessary to alter the design, performance and dimensions of equipment and the right is reserved to make such changes without prior notice.*

## NUAIRE

Western Industrial Estate,  
Caerphilly, Mid Glam CF83 1XH  
United Kingdom.

Telephone: 029 2088 5911

Facsimile: 029 2088 7033,

Email: [info@nuaire.co.uk](mailto:info@nuaire.co.uk)

[www.nuaire.co.uk](http://www.nuaire.co.uk)