

Installation Guide

smart boxer

SBS Supply Unit

NUAIRE

NuAire Limited,
Western Industrial Estate,
Caerphilly, Mid Glamorgan,
CF83 1XH, United Kingdom.
Tel: 029 2088 5911 Fax: 029 2088 7033
Email: info@nuaire.co.uk
www.nuaire.co.uk

Leaflet 670889

JANUARY 2002

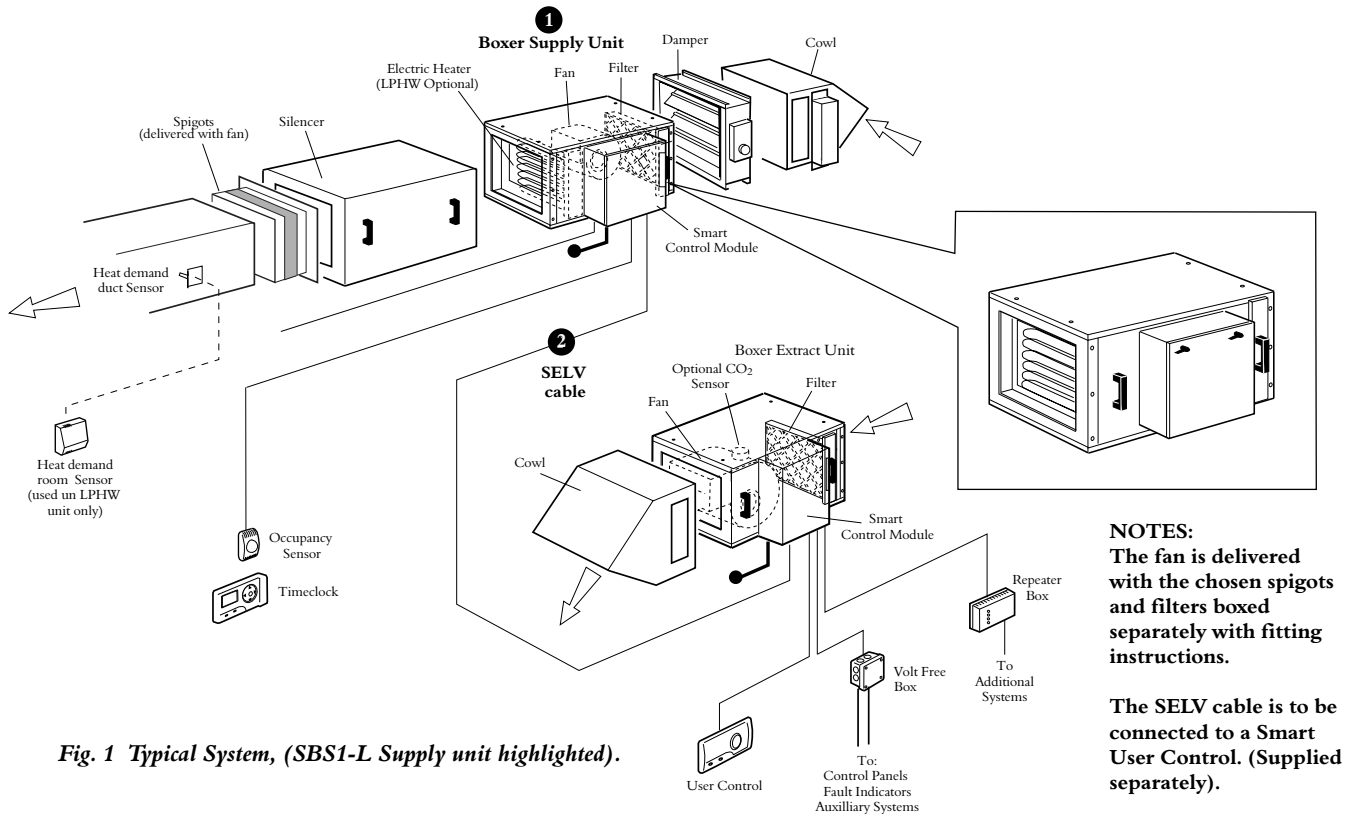

Fig. 1 Typical System, (SBS1-L Supply unit highlighted).

NOTES:
The fan is delivered with the chosen spigots and filters boxed separately with fitting instructions.

The SELV cable is to be connected to a Smart User Control. (Supplied separately).

The fan will not operate unless it is connected to a Smart User control. (Supplied separately).

Contents

Part 1. Check delivery against parts checklist

(If your delivery is incomplete, please telephone your distributor for this NuAire product. Note: Please have your delivery note and /or order number ready to speed your enquiry.

Part 2. Dimensions

Part 3. Handling

Part 4. Installation

Part 5. Connecting the electrical supply

(Also making the SELV customer connections for various sensors and auxilliary functions).

Part 6. Setting and operating the unit

(Detailing the adjustments available to customise performance).

Part 7. Troubleshooting

(A quick reference for easy set up).

Certification

Part 8. Maintenance

Part 1

Parts check list

- 1 SBS Smart Boxer Supply Fan Unit
- 2 1 off 10 metre length of plugged SELV cable

NOTE:

FAN WILL NOT OPERATE UNLESS IT IS CONNECTED TO A SMART USER CONTROL. (Supplied separately).

Supply Unit

(Code SBS1-L, SBS2-L, SBS1-E SBS2-E)

This is a combined fan / heater and filter unit and can be used alone or as part of a supply / extract system. Operation of the fan(s) is achieved via a Smart user Control (supplied separately).

Note: Code suffix **-L** = LPHW heater section
Code suffix **-E** = Electric heater section

Supply Unit without heater

(Code SBS1, SBS2)

This unit comprises a fan and filter only.

Part 2. Dimensions

Supply Unit only

Fig. 2 Smart Boxer (SBS1-E unit illustrated).

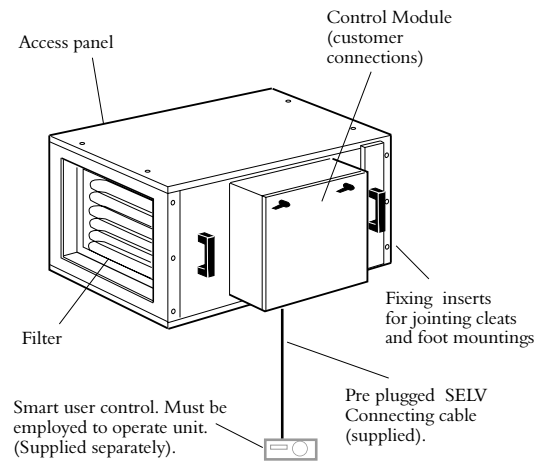
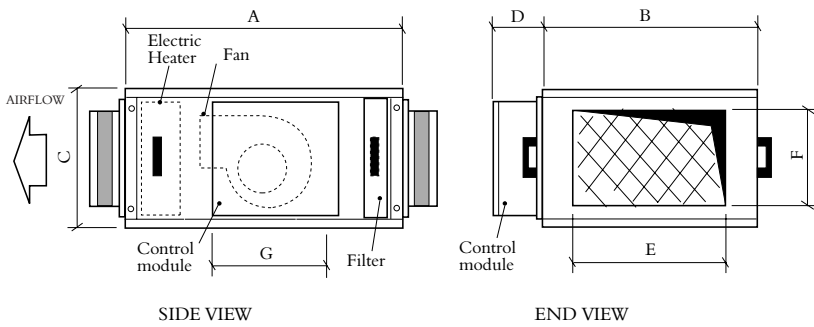

Dimensions (mm)-Maximum Shown

Unit Code	A	B	C	D	E	F	G	Weight (kg-Max)
SBS1-E	1000	684	480	200	500	300	600	101 (Elec. heater)
SBS2-E	1130	684	620	200	457	457	600	133 (Elec. heater)
SBS1-L	1000	684	480	290	500	300	670	110 (LPHW heater)
SBS2-L	1130	684	620	290	457	457	770	138 (LPHW heater)
SBS1	700	684	480	200	500	300	300	64 (No heater)
SBS2	1000	684	620	200	457	457	400	97 (No heater)

Silencer Unit only

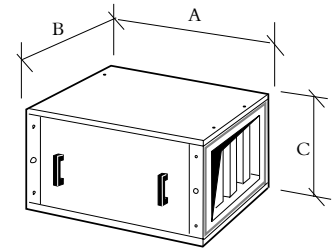

Cowl (supply or Extract)

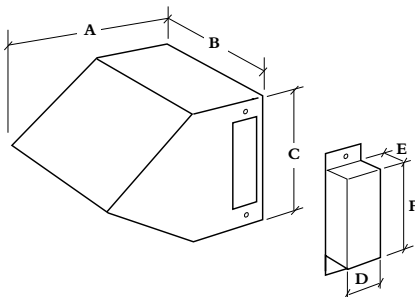

Matching weathering cowl for inlet or outlet use. Manufactured from recyclable "Solissime" coated galvanised steel for excellent corrosion resistance.

Dimensions (mm)

Unit Code	A	B	C	D	E	F	Weight(Kg)
SBRT 1	570	684	435	100	150	300	11
SBRT2	605	684	575	100	150	430	12

Ancillaries

Dimensions (mm)

Unit Code	A	B	C	Weight(Kg)
SBSIL1-S	700	684	480	36
SBSIL2-S	700	684	620	44
SBSIL1-L	1400	684	480	72
SBSIL2-L	1400	684	620	88

Damper Unit only

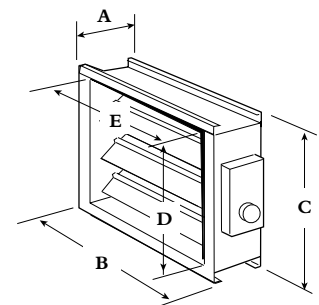

Dimensions (mm)

Unit Code	A	B	C	D	E	Weight(Kg)
SD1	160	620	415	365	540	14
SD2	160	620	560	510	540	17

Part 3. Handling

Lifting, moving and storage of equipment

When moving the units follow the procedure as shown in the diagrams. Do not attach lifting devices other than those shown. When using slings ensure that spreaders are employed to prevent damage to the unit casings (see fig.3).

Equipment should be stored in a dry location and protected from the accumulation of building dust and debris.

Do not stack the equipment during storage. Ensure that no impact loads are applied to the equipment

The handles fitted to the side panels of the units are for panel removal only. DO NOT attempt to move the unit using the handles.

Note: Avoid the panel handles when lifting. Consider the centre of gravity of the unit- this is not always central to the unit.

Part 4. Installation

Installation Options

The Smart Boxer can be installed using a number of different methods. This provides flexibility to cater for particular on site conditions. Note that for units delivered as individual modules; the spigot plates (packed separately and delivered with the fan unit) should be fitted to the outer modules e.g. silencers, at each end of the assembly.

Assembly of the modules

The module to module assembly is similar for all the unit sizes. Each module is constructed from six panels. End panels are designed to attach to the corresponding panel in the adjacent module and provide mounting points for the assembly.

The modules are assembled together using cleats, mounting feet or, for certain modules, closure plates.

All fixings necessary are provided. The fixings are vibration proof.

Clamping cleats are manufactured in heavy gauge mild steel and are designed to draw the end panels together into the correct position for gasket compression. For fitting, slacken the relevant vibration-proof bolts to show approximately 4mm of exposed thread and slide the cleat into position. A sharp blow to the folded edge will then engage the cleat. (See fig.4).

Mounting Feet, pressed in mild steel, provide for both attachment and mounting of the assembly. Note that AV mountings are available and selection and fitting details are detailed in these pages.

Closure Plates, are supplied with the Bend Modules and also the Heat Exchanger Modules.

NOTE: In all cases when positioning adjacent modules, ensure that the gasket material is not displaced.

Unit Mounting floor or roof (fig. 5 & 6)

On a smooth and level surface, capable of supporting the assembled weight of the units, no assembly frame is required. This has the advantage of minimising the overall height of the unit.

An uneven mounting surface will impose undue strain upon the assembly. In extreme cases this may cause leakage and component failure. A simple builders work upstand may be used to raise the equipment from the floor level. (See fig. 6).

Note: this will be necessary where cooling coils and heat exchangers are specified in order to allow fitting of the appropriate condensate drainage trap.

Construct the upstand to support the base periphery of the assembly. Position the modules in the correct order and assemble using clamping cleats. Mounting feet should be used, at least at every other joint, secured to the mounting surface. It is normal practice to fit a resilient matting between the unit and the mounting surface. See 'Using A.V. Mountings (page 5).

Where supplied with a base frame the module assembly needs only to be positioned and secured to the floor. Again, the surface should be level and additional height may be required for drainage traps.

Assemblies are supplied in maximum lengths of 2.4metres. Longer assemblies must be joined on site (fixings supplied).

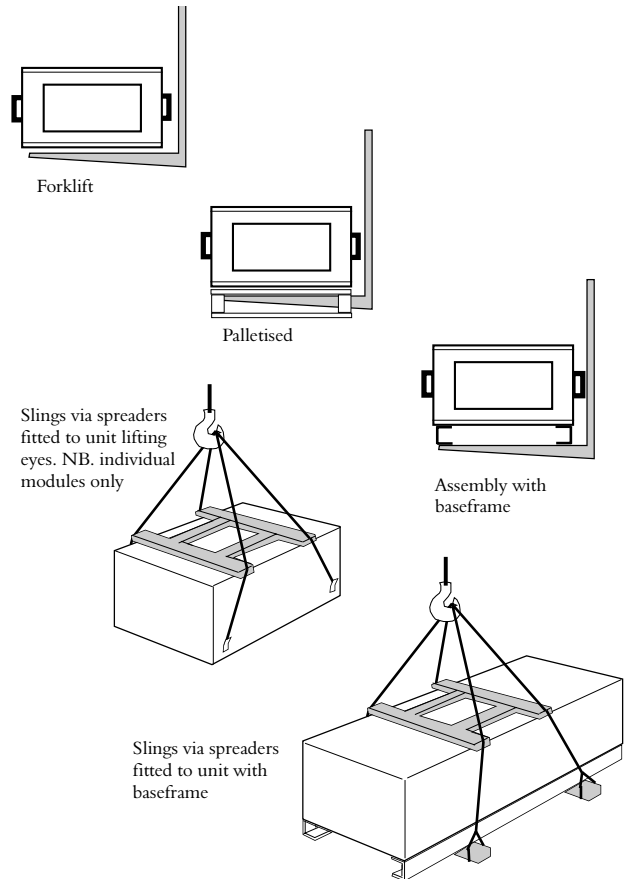

Fig. 3 Lifting and moving the unit.

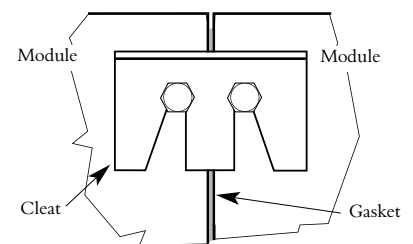

Fig. 4 Fitting a cleat

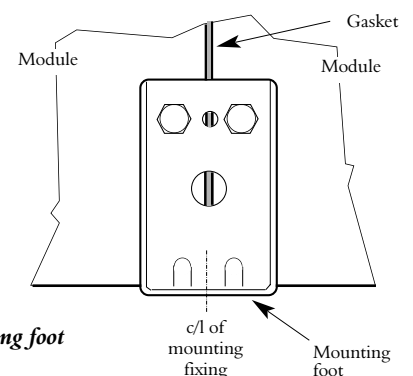

Fig. 5 The mounting foot

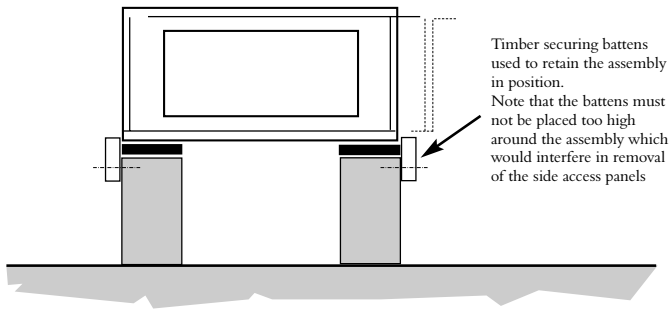

Fig. 6 Simple builders upstand mounting assembly.

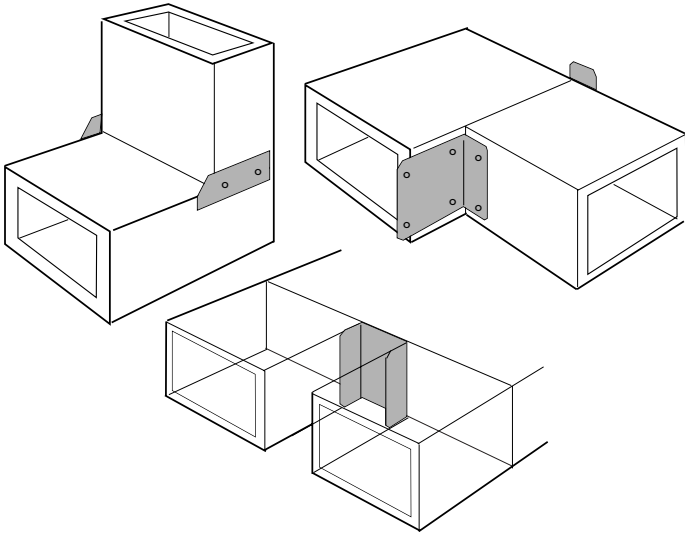
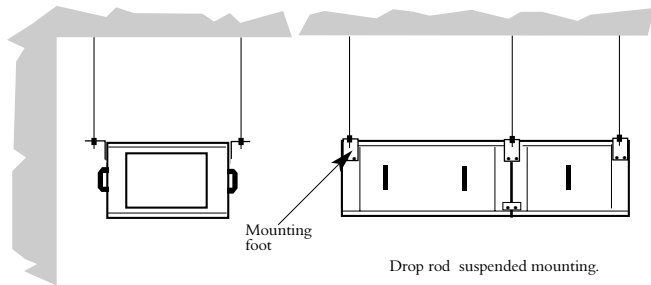

Fig. 7 Closure Plates used on Bend and Heat Exchanger modules.



Note: Spacing of supports coincides with module length

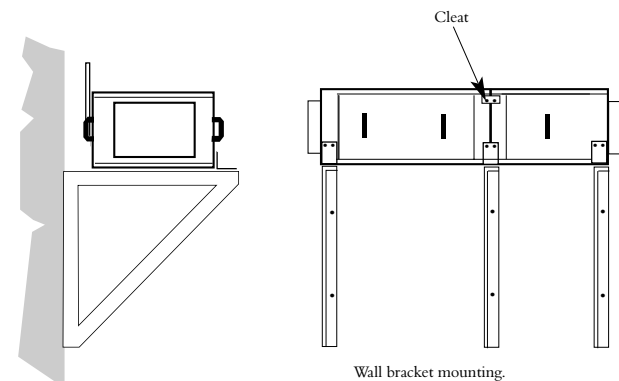

Fig.8 Suspended and wall mounting typical arrangements.

High level mounting (fig. 8)

For suspended mounting the installer must consider safe working access for construction and also subsequent maintenance, with particular regard to removal of access panels.

For baseframe mounted assemblies, the installer must provide a series of level supports for attachment of the baseframe. Supports of cantilever or drop rod design must be adequately sized and securely fixed.

Supports should be evenly distributed along the length of the assembly with a recommended maximum span between supports of 1.5metres. Not more than 150mm of baseframe should overhang the outermost supports.

Note that the baseframe / module assembly as supplied has a maximum length of 2.4 metres. For longer assemblies, both the modules and the baseframe will need to be joined on site (fixings are supplied).

Installation procedure

- Fit the first two supports at one end of the assembly.
- Fit mounting feet to the unit. Lift the unit onto the supports and secure with fixings.
- Install the third support.
- Lift the second module into place and attach it to the mounting feet. Attach the free end to the third support.
- Fit cleats to the first joint.
- Continue the procedure until all modules are in position checking each joint is properly aligned.
- Check the tightness of all bolts and that the fixings to the supports are secure.

Ensure that the supports do not impose any undue loads on the component due to misalignment.

Note that when installing a module near to a wall, sufficient clearance must be allowed for fitting of the mounting feet and access to the fixing bolts.

Connecting the ductwork.

Assuming the assembly of the modules is complete, the spigot plates delivered with the fan may now be fitted to the outer modules. All fixings are supplied.

The units are supplied with rectangular flexible spigots as standard. (Circular spigots available). The unit can be used 'stand alone' in ductwork, or the spigot(s) can be removed and the fan unit butt jointed to other Boxer Modules using the clamp plates and mounting feet supplied. Make spigot connections to ductwork using circlips, jubilee clips or riveting. The weight of the ductwork should be separately supported. The ductwork should also be properly aligned with the connecting spigots. Flexible spigots should be extended so that they do not impede the airflow but flexibles must not be stretched as this could allow the transmission of vibration.

To achieve the rated airflow performance there should be at least 1 metre of straight ducting at both ends of the module assembly and any bends or restrictions should be positioned as far away from the unit as is possible.

Module requirements

General

All access panels are secured by M6 x 50 screws which are retained in the panel. During routine maintenance only one access panel at any time should be removed from the unit. When a panel is removed, the condition of the sealing gasket tape should be checked and replaced if necessary.

Before attempting any maintenance on any component in the system, **THE ENTIRE SYSTEM MUST BE ELECTRICALLY ISOLATED** using lockable isolators.

Using A.V. Mountings

The Smart Boxer units are also supplied as standard with four mounting feet. Anti-vibration mountings are available to order and carry an AV code which matches with the unit size. Various hardnesses are designed to be fitted in particular positions denoted by a colour coding. The A.V. mountings should be selected and located as shown in the drawing and table.

When using AV mounts in suspended applications the mounts are located under the feet. The drop rods are passed through the feet and the A.V.'s are threaded up the drop rods. With the unit level the A.V.'s are fixed to the underside of the feet. The large washers supplied MUST be placed underneath before fixing the M10 nuts and lock nuts.

NOTE: A.V. mountings are only used in compression. The mounts must NEVER be used in tension.

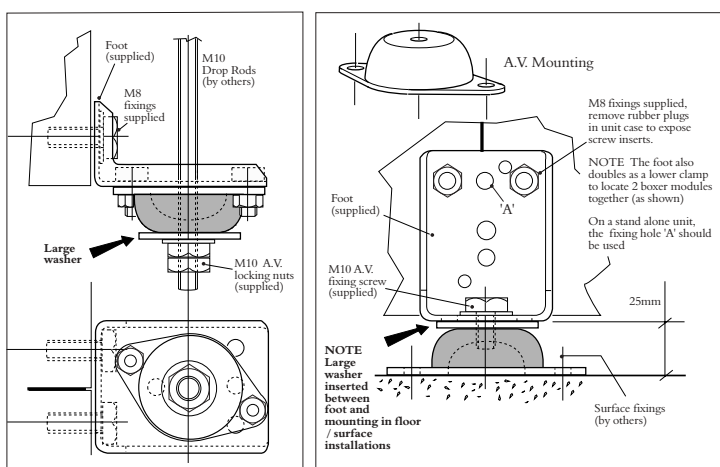

A.V Used in suspended application. Note washer position

A. V. Used in a floor / surface mounted application

Fig.9 Typical AV applications, surface & suspended

The various hardnesses of the A.V. mounts are denoted by a colour coding and their application is detailed below.

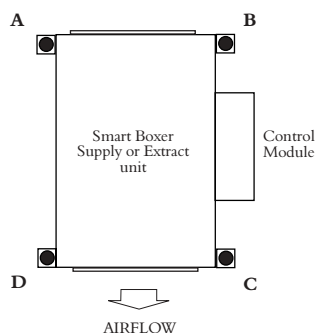

A.V. selection

Unit	A.V. Code	Position on unit			
		A	B	C	D
SBS1-E	SBAV1	BLUE	YELLOW	YELLOW	BLUE
SBS2-E	SBAV2	YELLOW	RED	RED	YELLOW
SBS1-L	SBAV3	YELLOW	YELLOW	YELLOW	YELLOW
SBS2-L	SBAV2	YELLOW	RED	RED	YELLOW
SBS1	SBAV4	BLUE	BLUE	BLUE	BLUE
SBS2	SBAV5	BLUE	YELLOW	YELLOW	YELLOW

Part 5

Connecting the electrical supply Electrical information

ISOLATION

BEFORE COMMENCING WORK MAKE SURE THAT THE UNIT IS ELECTRICALLY ISOLATED FROM THE MAINS SUPPLY.

Power requirements

WITHOUT HEATER

MOTOR 1 Phase (230v)

Unit Code	sc (amps)	flc (amps)
SBS1	n/a	4.84
SBS2	n/a	7.30

WITH HEATER (ELECTRIC)

MOTOR 1 Phase (230v)

Unit Code	sc (amps)	flc (amps)
SBS1 -E	n/a	4.84
SBS2 -E	n/a	7.30

HEATER 3 Phase (400v)

Unit Code	Max.Rating (kW)	flc (amps)
SBS1 -E	18	25*
SBS2 -E	24	33*

NOTE:
See page 9 for Electric Heater Air On/Air Off details & Battery sizes

Note: Heater is default factory set at the maximum kW rating (see page 6).

* Flc is a calculation based on the maximum kW rating.

WITH HEATER (LPHW)

MOTOR 1 Phase (230v)

Unit Code	sc (amps)	flc (amps)
SBS1 -L	n/a	4.84
SBS2 -L	n/a	7.30

NOTE:
See page 9 for LPHW Heater Air On/Air Off details & kW sizes

Customer wiring into fan control box

(Electric heater model illustrated.)

See page 9 for LPHW heater model)

IMPORTANT

The fan will not operate unless it is connected to a Smart User control. (Supplied separately).

See overleaf:

'Connecting the Sensors or User Control cables'

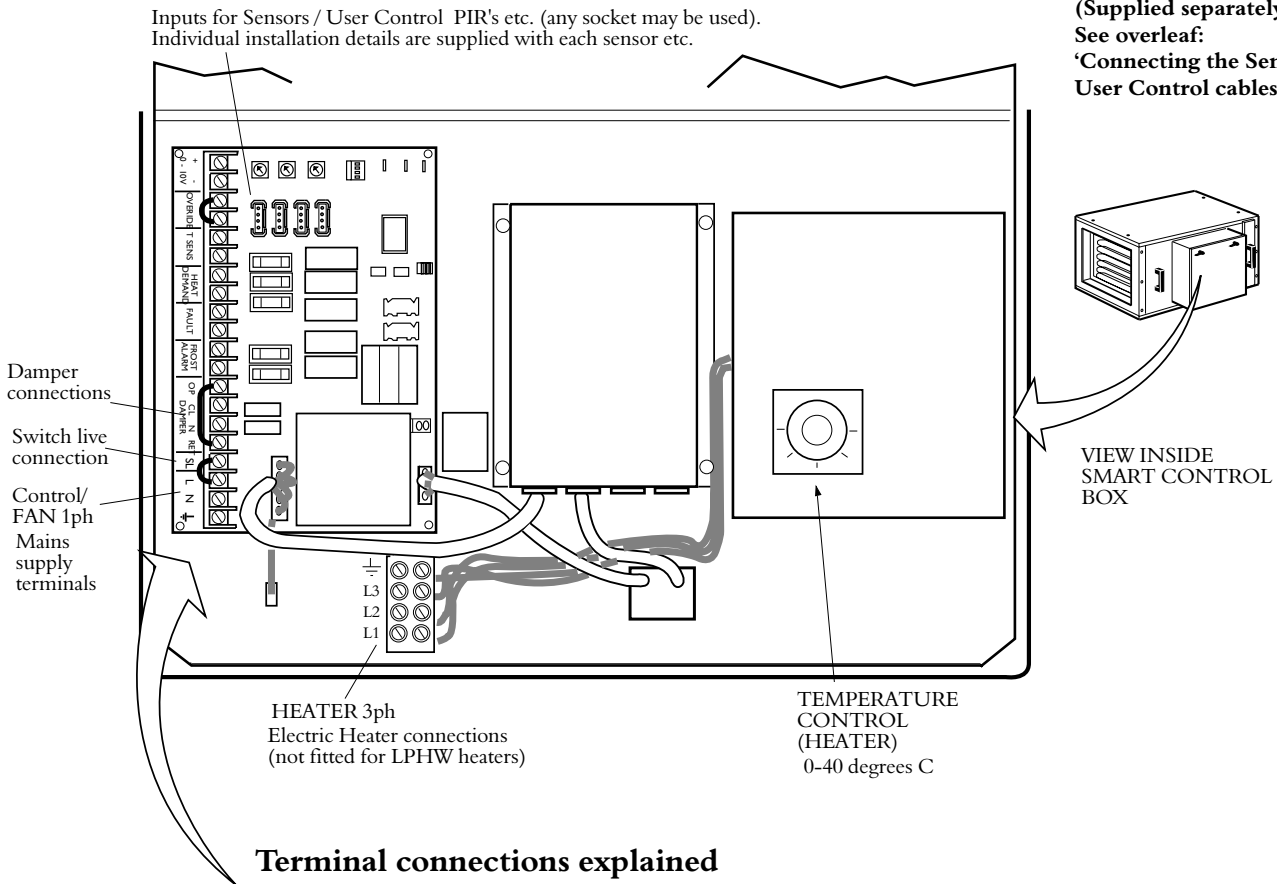

Terminal connections explained

- BEMS** 0-10v dc signal used to control speed of fan.
- OVERRIDE** 12v for connection to voltfree contacts
- T SENS** Connection point for duct mounted temperature sensors. A room mounted sensor is available on the LPHW units and should be connected here.
- HEAT DEMAND** When 'winter' mode is selected and fan is running, these contacts close. Rated 1A 230v
- FAULT** 2 terminals supplied- Fused to 1A These are volt free contacts. Closed when system is operating normally. When a fault occurs the contacts will open and break the circuit.
- FROST ALARM** In the event of frost (5°C) detected on the LPHW coil, this contact will close and shut the unit down. (L units only).
- OP=OPEN:** 230v ac (1A rating) powered when fan is selected to run.
- CL=CLOSE:** 230v ac (1A rating) powered when fan is selected to stop.
- N =NEUTRAL:** Neutral connection for convenience wiring damper
- RET=RETURN:** 230v ac input signal - This is a feedback signal that can be connected to a limit switch. Signal changes from 0 - 230v when damper is fully opened. Allows the damper to be fully opened before the fan begins to run.
- SL =SW LIVE** At 0 volts ac the system is off (unless trickle mode is enabled). 3 volts to 230 volts will activate the system.

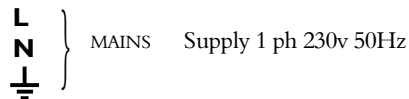

- HEATER** Electric Heater supply terminals (3 phase) E units only
- SBS1-E (18 kW)
- SBS2-E (24kW)

Damper connections

Individual connection details are shown overleaf

Customer wiring to the Fan Control Box (continued)

Normal operation

No auxilliary devices being employed

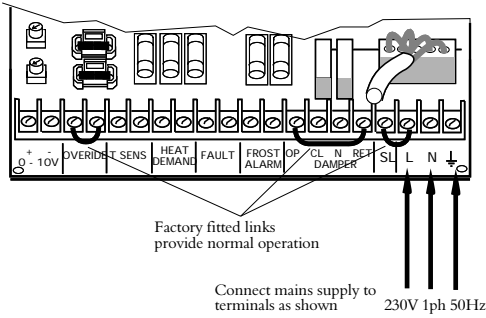

Switched Live Connection

When 230v a.c. is applied to the switch live terminal the fan will run.
When the 230v a.c. is removed from the switch live the fan will stop.

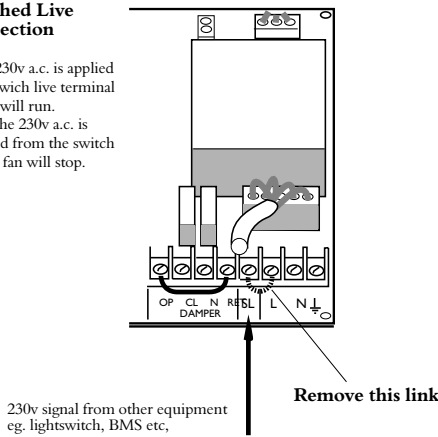

Damper Connection

POWERED OPEN
230v a.c. (1A) is provided on OP terminal to power open a damper. (This could also be used to switch auxilliary equipment).

POWERED CLOSE:
230v a.c. (1A) is provided on CL terminal to power close a damper.

LIMIT SWITCH
If using a limit switch when opening a damper:
1 Remove link (a)
2 Connect 230v a.c. to common connection point.
3 Connect N/O connection of Limit Switch to RET terminal.

Note:
An extra NEUTRAL terminal is provided for convenience when using a Damper

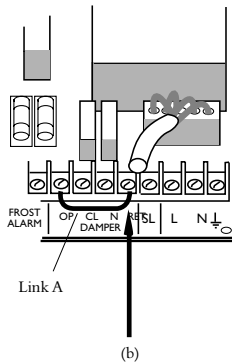

Fan Fail signal connection

This connection is a volt free switch. It is rated at 1A (230v) and has been fused at 1A for protection.

NO FAULT
The volt free switch is closed (i.e. a & b are connected).

FAN FAULT
The volt free switch is open (i.e. a & b are disconnected).

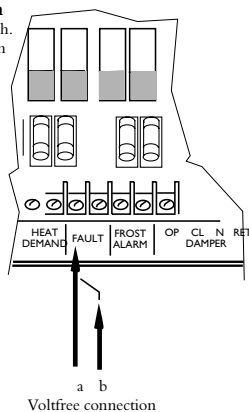

Speed Control via 0 - 10v dc signal BEMS

BMS Control Voltages

(Terminals bottom left of control panel)

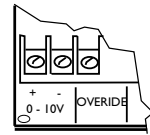

SUMMER MODE		WINTER MODE	
Volts*	Function	Volts*	Function
0	Local Control Local Panel disabled / Off	0	Local Control Local Panel disabled / Off
0.25		0.25	
0.5	Speed 1	1	Speed 1
1.5	Speed 2	2	Speed 2
2.5	Speed 3	3	Speed 3
3.5	Speed 4	4	Speed 4
4.5	Speed 5	5	Speed 5
5.5	Speed 6	6	Speed 6
6.5	Speed 7	7	Speed 7
7.5	Speed 8	8	Speed 8
8.5	Speed 9	9	Speed 9
9.5	Speed 10	10	Speed 10
Heater 'ON'			

*Tolerance $\pm 125mV$

Connecting the Sensors or User Control cables (supplied)

Any of the 4 sockets may be used

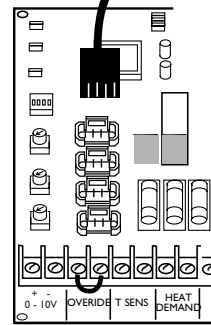

SUPPLY ONLY
Connect the other end of the cable to the user control (control supplied separately)

SUPPLY / EXTRACT
As above. Also a second cable is employed to connect the two fans together.

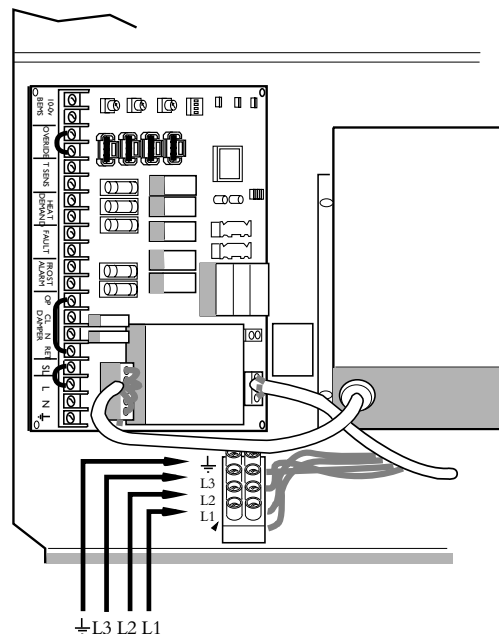

Electric Heater Connections

3 Phase 400v 50Hz
Connect supply as shown

Note: SBS1-E is 18kW
SBS2-E is 24kW

Part 6. Setting and operating the unit

Adjustments

The installer can adjust the following features and customise the Smart Boxer system to meet his particular requirements:

Min. / Max. setting on Fans

The speed of the fan can be adjusted inside the control module mounted on the side of the Smart Boxer. The maximum speed can be reduced by rotating the relevant screw anti-clockwise. Using this feature, the min/max extract rate can be fine-tuned to suit individual requirements.

NOTE: Turning the Min speed adjuster fully anti clockwise and the Max speed adjuster fully clockwise will set the speed to 100 %, see drawing opposite.

Adjusting min / max speed

Using a small screwdriver in the potentiometers, the speed may be adjusted to suit your requirements

Minimum speed adjustment

Maximum speed adjustment

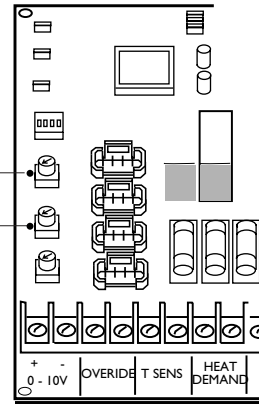

Override (See note on Page 6)

When the factory fitted link is removed and the fan is operated via a remote switch / relay, the fan will stop running when 'A' is disconnected from 'B' See drg

Please note that there will be no run-on when the Heater has been enabled. For BMS or Timeclock operation use the Switch Live input to preserve Run On.

Heat Demand (Volt Free Connection)

Maximum load 230v 1A to signal external equipment that the fan is running and that 'Winter' mode is enabled.

Frost Alarm (Volt Free Connection)

Maximum load 230v 1A. When frost is detected over the coil (5°C) this contact is activated and fan shuts off, any dampers is closed and a RED led blinks to signal frost on supply unit. (Only used on SBS1L & SBS2-L supply units)

Temperature Sensor

Connection point for duct mounted temperature sensors. A room mounted sensor is available on the LPHW units and should be connected here.

Locating the Duct Mounted Temperature Sensor

Note Sensor is supplied separately. The Temperature Sensor should be located a minimum of 1.5 m downstream of the unit. (See drawing below).

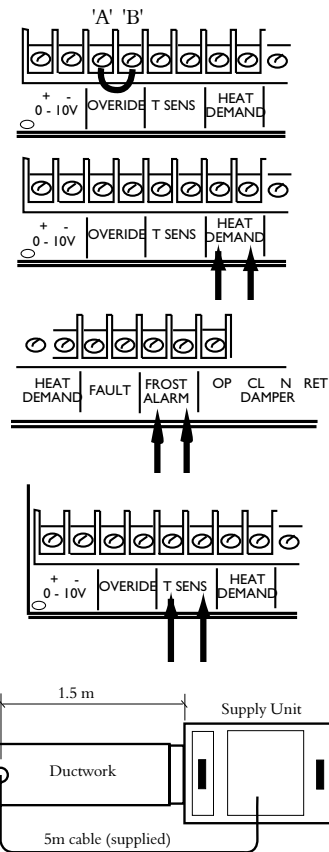

Setting the function switches

NOTE:
A1 and B2 are factory set (do not touch)

C3 'ON'

= Damper operational
No delay, fan will start immediately



C3 'OFF'

= Fan has delayed start to allow the damper to open (60 seconds)

D4 'ON'

= Enables trickle mode.
Fan runs at trickle even when switched off.*

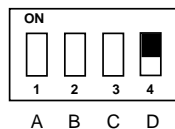

D4 'OFF'

= No trickle operation

* Disconnecting override will stop the fan.

Function switches

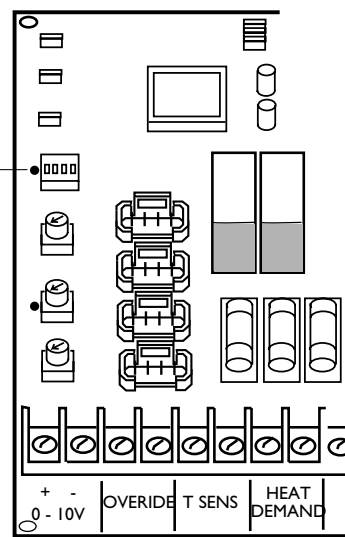

Adjustments (continued)

ELECTRIC HEATER

Adjusting the Air Off temperature

The adjustment knob is calibrated from 0-40 °C. (See drawing opposite). Rotate the knob to the desired 'Air Off' temperature.

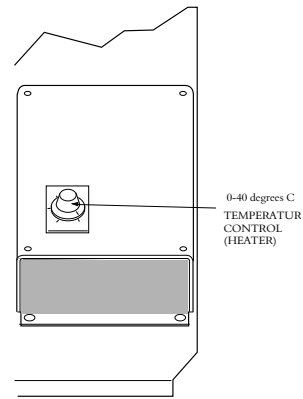

ELECTRIC HEATER ELEMENT OUTPUT

The unit is supplied with the heater elements configured for the maximum kW output. This is 24kW for SBS2-E and 18kW for SBS1-E. It is possible to reconfigure the unit on site to give a reduced output if desired. Details of the correct procedure are available from NuAire on request. (Leaflet No 670940)

NOTE BELOW:

“Air OFF” refers to air coming off the heater. “Air ON” refers to air as it arrives at the heater.

ELECTRIC HEATER BATTERY SIZES FOR SMART BOXER UNITS	SBS1-E				SBS2-E			
	Duty m ³ /s	Air ON	Air OFF	kW	Duty m ³ /s	Air ON	Air OFF	kW
	0.05	-3	21	1.5	0.05	-3	21	1.5
	0.10	-3	21	3	0.10	-3	21	3
	0.15	-3	21	4.5	0.15	-3	21	4.5
	0.20	-3	21	6	0.20	-3	21	6
	0.25	-3	21	7.5	0.25	-3	21	7.5
	0.30	-3	21	9	0.30	-3	21	9
	0.35	-3	21	10	0.35	-3	21	10
	4.00	-3	21	12	4.00	-3	21	12
	0.45	-3	21	13	0.45	-3	21	13
	0.50	-3	21	14.5	0.50	-3	21	14.5
	0.55	-3	21	15.8	0.55	-3	21	15.8
	0.60	-3	21	18	0.60	-3	21	18
					0.65	-3	21	19
					0.70	-3	21	20
					0.75	-3	21	22
					0.80	-3	21	23
					0.85	-3	21	24

L.P.H.W. HEATER

Adjusting the Air Off temperature

The adjustment knob is calibrated from 15-30 °C. Rotate the knob to the desired 'Air Off' temperature.

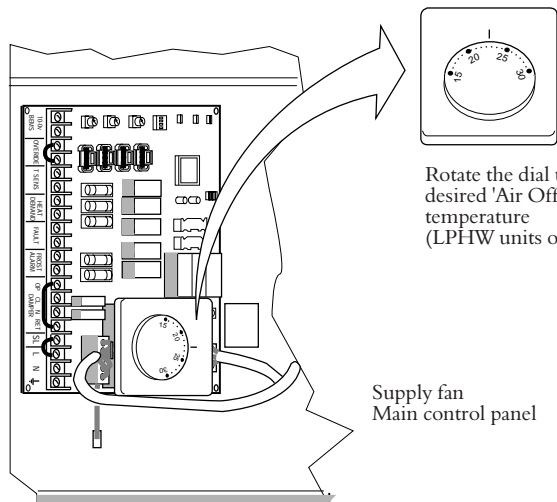

Rotate the dial to the desired 'Air Off' temperature (LPHW units only)

Supply fan Main control panel

LPHW kW sizes for Smart Boxer units

SBS1-L

270 Blower Coil B4-LW-D

Duty m ³ /s	Air ON	Air OFF	Air off	Flow Rate	Fluid PD.	Valve Set
0.1	-3	70	8.6	0.32		B1
0.2	-3	53	13	0.32		B1
0.3	-3	44	16.3	0.36	refer to	B1
0.4	-3	38	18.8	0.41	Nuair	B1
0.5	-3	34	21.1	0.46		B1
0.6	-3	31	23.2	0.50		B1
0.7	-3	28	24.5	0.53		B1

SBS2-L

330 Blower Coil B5-LW-D

Duty m ³ /s	Air ON	Air OFF	Air off	Flow Rate	Fluid PD.	Valve Set
0.1	-3	70	8.6	0.4		B1
0.2	-3	51	12.5	0.4		B1
0.3	-3	45	16.6	0.4	refer to	B1
0.4	-3	38	18.8	0.41	Nuair	B1
0.5	-3	33	20.5	0.45		B1
0.6	-3	30	22.4	0.49		B1
0.7	-3	27	23.6	0.52		B1
0.8	-3	25	25.1	0.55		B1

L.P.H.W. HEATER (continued)

SBS1-L and SBS2-L units fitted with LPHW heater coils

The LPHW Boxer Supply unit coils incorporate a three port control valve and interconnecting pipework. Isolation valves at inlet and outlet ports are provided and a Double regulating (DRV) valve is fitted in the control valve bypass. The flow isolating valve contains an internal filter mesh. The DRV valve provides isolation and regulation facilities. Full flow through the coil can be matched through the bypass when the three port valve is operating on full bypass, by adjusting the DRV.

To accurately measure the flow through the bypass and to the Boxer unit install a flow measurement device in the 'field' (branch) pipework serving the unit. Measure the flow with the three port valve fully open (flow through coil). and also with the valve on full bypass. Match the reading to the reading achieved through the coil by regulating the DRV.

Isolating the water supply

The FLOW and RETURN valves are located in the pipework on the case control side. See drawing

Note: Frost Prevention

It is the responsibility of the installer to prevent frost damage to the unit. Lagging of external pipework should be undertaken during installation.

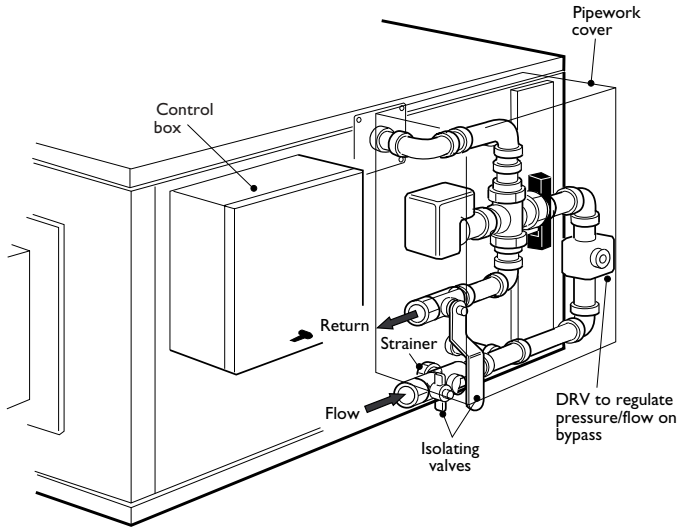

Part 7.

Troubleshooting for Smart Boxer Systems

Problem

System power is on, power and status light on user control is green, fan lights are off and switch has been moved to summer / winter mode but fan is not running.

Solution

The SW Live connector may not have 230v AC connected to it; or similarly, when a limit switch is used with a damper, the 'DAMPER RETURN' does not have 230v AC connected to it.

Problem

System power is on but no lights showing on the user control.

Solution

Check SMARTCABLE-10/Net connections or check the 3 amp fuse labelled 'Control Supply' in the customer connection box.

Problem

System power is on but user control displays a red light next to 'Supply / Extract Fan'

Solution

Fan has failed -contact a service engineer.

Problem

The user control has been switched to the OFF position but the green light stays on indicating that the fan /s are still running.

Solution

This is a normal condition. Notice that the heater light is amber. This indicates that the system has been switched from winter mode to summer \ OFF. The fan has a built in run on timer which runs for 10 minutes. This is necessary to disperse any residual heat.

Problem

The Supply unit does not heat the air.

Solution

Check the temperature control (0-30 deg C dial on the side of the fan.

Problem

The user control displays an amber light next to a fan.

Solution

Check the SMARTCABLE - Net connections.
Check power / fuses to the customer connection box.

Troubleshooting for Smart Boxer Systems (continued).

Models SBS1-E & SBS2-E

(Supply units with electric heaters).

HEATER OPERATION CHECKLIST

1. *If you are not getting adequate heat delivered from the unit* first check that the user control is switched to WINTER and that the light next to the heater is GREEN.
2. *If you are not getting adequate heat delivered from the unit* also check that the duct sensor been installed in the ductwork and connected to the terminals marked 'T SENS'
3. *If you are not getting adequate heat delivered from the unit* also check that the temperature set point has been adjusted to an effective position, e.g. 20°C would be a typical user setting.
4. When the heater is in use a RED light marked 'RATIO' shows on the heater
If the RED light on the heater control marked 'RATIO' is not on or blinking, this will indicate either :-
 - a) No heat is required - check the temperature set point, is it adjusted too low to operate the heater
 - b) The Thermal Trip has shut off the heater and will need to be reset.
Undo the small access cover on top left of control module (see drawing) and press pin to reset.
5. Make sure that 3 phase is connected and present on the heater supply terminals.
6. Check all 3-barrel fuses on the heater control.

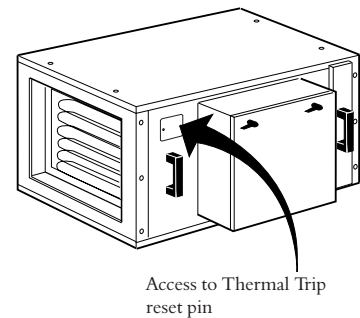

Using Smart Boxer and Smart Sqrbo systems together

SmartSqrbo and SmartBoxer systems may be used together
Smart Controls including User controls, Sensors and other auxilliary devices are fully compatible with both SmartSqrbo and SmartBoxer systems.

Typical mixed applications are shown below

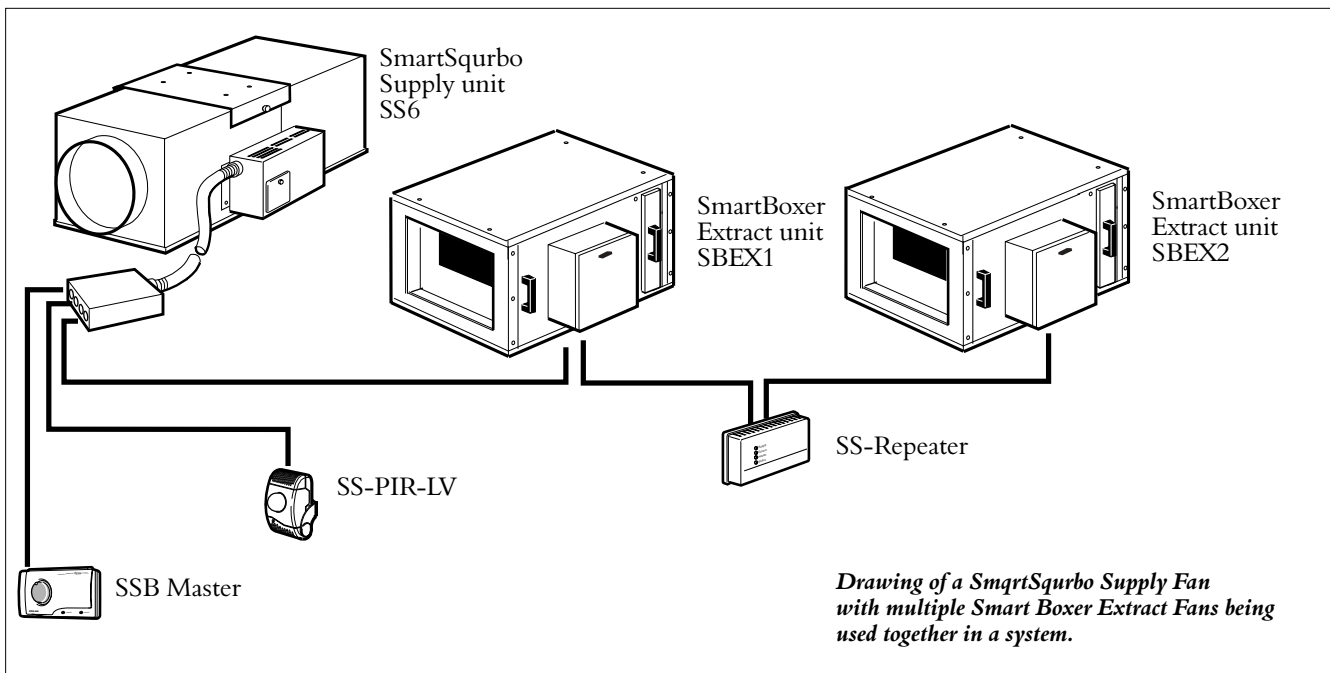
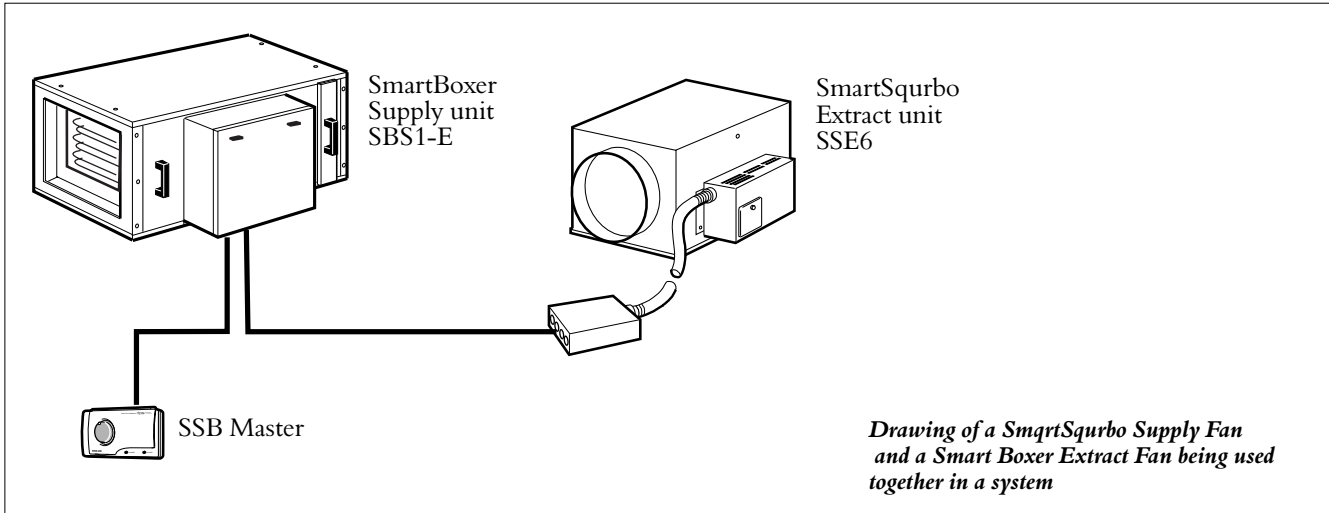

NUAIRE

CE DECLARATION OF CONFORMITY



NuAire Limited,
Western Industrial Estate,
Caerphilly, Mid Glamorgan,
CF8 1XH. United Kingdom.
Telephone: 029 2088 5911
Fax: 029 2088 7033
Email: info @ nuair.e. co. uk
www.nuair.e.co.uk

APRIL 2000

*We declare that the machine named below
conforms to the requirements of EC Council Directives
relating to Electromagnetic Compatibility and
Safety of Electrical Equipment.*

Designation of machinery :-	SMART BOXER SYSTEM
Machinery Types :-	SBS
Relevant EC Council Directives :-	89/336/EEC, 92/31/EEC (EMC) 73/23/EEC, 93/68/EEC (Low Voltage Directive)
Applied Harmonised Standards :-	E55014-1, EN55014-2, EN60204-1 EN60335-2-80
Basis of Self Attestation :-	Quality Assurance to BS EN ISO 9001 BSI Registered Firm Certificate No. FM 149

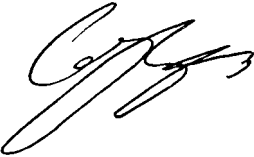
Signature of manufacture representatives :-

	Name:	Position:	Date:
1)	 C. Biggs	Technical Director	3. 3. 00
2)	 W. Glover	Manufacturing Director	3. 3. 00

NUAIRE

DECLARATION OF INCORPORATION & INFORMATION FOR SAFE INSTALLATION, OPERATION & MAINTENANCE

NuAire Limited,
Western Industrial Estate,
Caerphilly, Mid Glamorgan,
CF8 1XH. United Kingdom.
Telephone: 029 2088 5911
Fax: 029 2088 7033
Email: info @ nuaire. co. uk
www.nuair.co.uk



APRIL 2000

We declare that the machinery named below is intended to be assembled with other components to constitute a system of machinery.

The machinery shall not be put into service until the system has been declared to be in conformity with the provisions of the EC Council Machinery Directive.

Designation of machinery :-	SMART BOXER SUPPLY UNIT
Machinery Types :-	SBS
Relevant EC Council Directives :-	98/37/EC (Machinery Directive)
Applied Harmonised Standards :-	EN292-1, EN292-2, EN294, EN29001
Applied National Standards :-	BS848 Parts One, Two and Five

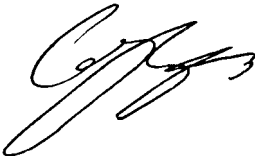
Signature of manufacture representatives :-

	Name:	Position:	Date:
1)	 C. Biggs	Technical Director	3.3.00
2)	 W. Glover	Manufacturing Director	3.3.00

INFORMATION FOR SAFE INSTALLATION, OPERATION AND MAINTENANCE OF NUAIRE VENTILATION EQUIPMENT

To comply with EC Council Directives 98/37/EC Machinery Directive

To be read in conjunction with the relevant Product Documentation (see 2.1)

1.0 GENERAL

- 1.1 The equipment referred to in this **Declaration of Incorporation** is supplied by NuAire to be assembled into a ventilation system which may or may not include additional components.
The entire system must be considered for safety purposes and it is the responsibility of the installer to ensure that all of the equipment is installed in compliance with the manufacturers recommendations and with due regard to current legislation and codes of practice.

2.0 INFORMATION SUPPLIED WITH THE EQUIPMENT

- 2.1 Each item of equipment is supplied with a set of documentation which provides the information required for the safe installation and maintenance of the equipment. This may be in the form of a Data sheet and/or Installation and Maintenance instruction.
2.2 Each unit has a rating plate attached to its outer casing. The rating plate provides essential data relating to the equipment such as serial number, unit code and electrical data. Any further data that may be required will be found in the documentation. If any item is unclear or more information is required, please contact NuAire.
2.3 Where warning labels or notices are attached to the unit the instructions given must be adhered to.

3.0 TRANSPORTATION, HANDLING AND STORAGE

- 3.1 Care must be taken at all times to prevent damage to the equipment. Note in particular that shock to the unit may result in the balance of the impeller being affected.
3.2 When handling the equipment, care should be taken with corners and edges and that the weight distribution within the unit is considered. Lifting gear such as slings or ropes must be arranged so as not to bear on the casing.
3.3 Equipment stored on site prior to installation should be protected from the weather and steps taken to prevent ingress of contaminants.

4.0 OPERATIONAL LIMITS

- 4.1 It is important that the specified operational limits for the equipment are adhered to *e.g. operational air temperature, air borne contaminants and unit orientation.*
4.2 Where installation accessories are supplied with the specified equipment eg. wall mounting brackets. They are to be used to support the equipment only. Other system components must have separate provision for support.
4.3 Flanges and connection spigots are provided for the purpose of joining to ductwork systems. They must not be used to support the ductwork.

5.0 INSTALLATION REQUIREMENTS

- In addition to the particular requirements given for the individual product, the following general requirements should be noted.*
5.1 Where access to any part of equipment which **moves**, or can become **electrically live** are not prevented by the equipment panels or by fixed installation detail (eg ducting), then guarding to the appropriate standard must be fitted.
5.2 The electrical installation of the equipment must comply with the requirements of the relevant local electrical safety regulations.

6.0 COMMISSIONING REQUIREMENTS

- 6.1 General pre-commissioning checks relevant to safe operation consist of the following -
Ensure that no foreign bodies are present within the fan or casing
Check electrical safety. *e.g. Insulation and earthing.*
Check guarding of system.
Check operation of Isolators/Controls.
Check fastenings for security.
6.2 Other commissioning requirements are given in the relevant product documentation.

7.0 OPERATIONAL REQUIREMENTS

- 7.1 Equipment access panels must be in place at all times during operation of the unit, and must be secured with the original fastenings.
7.2 If failure of the equipment occurs or is suspected then it should be taken out of service until a competent person can effect repair or examination. (Note that certain ranges of equipment are designed to detect and compensate for fan failure).

8.0 MAINTENANCE REQUIREMENTS

- 8.1 Specific maintenance requirements are given in the relevant product documentation.
8.2 It is important that the correct tools are used for the various tasks required.
8.3 If the access panels are to be removed for any reason the electrical supply to the unit must be isolated.
8.4 A minimum period of two minutes should be allowed after electrical disconnection before access panels are removed. This will allow the impeller to come to rest.
NB: Care should still be taken however since airflow generated at some other point in the system can cause the impeller to "windmill" even when power is not present.
8.5 Care should be taken when removing and storing access panels in windy conditions.

Part 8 . Maintenance

ISOLATION

BEFORE COMMENCING WORK MAKE SURE THAT THE UNIT IS ELECTRICALLY ISOLATED FROM THE MAINS SUPPLY.

Maintenance Intervals

The first maintenance should be carried out three months after commissioning and thereafter at twelve monthly intervals. These intervals may need to be shortened if the unit is operating in adverse environmental conditions, or in heavily polluted air. Do not run the fan system in dust laden conditions prior to hand over as cement or plaster dust will cause premature clogging of the filters.

General Cleaning and Inspection

Access to the motor / impeller assembly can be gained by removing the main case cover

Inspect fan and motor assembly as follows; taking care not to damage, distort or disturb the balance of the impeller.

- a) Lightly brush away dirt and dust, paying particular attention to any build up at the motor ventilating slots. If necessary, carefully remove with a blade or scraper.
- b) Stubborn dirt at the impeller may be carefully removed with a stiff nylon brush.
- c) Check all parts for security and general condition. Check that the impeller rotates freely.

Refit the assembly to the unit.

Lubrication

Motors are fitted with sealed for life bearings and therefore require no further lubrication

Filter care / replacement

The filter inside the Smart Boxer unit will require cleaning on a regular basis. The frequency of filter cleaning operations will depend on the site conditions.

Note: It is important to allow sufficient time for the heater battery to cool down before beginning work.

Remove the access panel and withdraw the filter. The filter may then be vacuumed.

Technical or commercial considerations may, from time to time, make it necessary to alter the design, performance and dimensions of equipment and the right is reserved to make such changes without prior notice.

NUAIRE

**Western Industrial Estate,
Caerphilly, Mid Glam CF83 1XH
United Kingdom.**

Telephone: 029 2088 5911

Facsimile: 029 2088 7033,

Email: info@nuaire.co.uk

www.nuaire.co.uk

Leaflet No. 670889

Service

As a manufacturer NuAire provides you with factory trained Service Engineers.

Our Engineers are supported by a comprehensive range of spare parts 'off the shelf'.

If you are an industrial or commercial user, you may be interested in details of NuAire's regular maintenance Service Contracts. This is a worthwhile service that helps you get the most from our products.

Our Service Department will be happy to give you more information.

Please telephone: 029 2085 8585

Controls Application Service (CAS)

A team of Engineers and technicians is available to provide pre and post order support.

We are on hand to provide help and advice from the most basic use of any NuAire equipment to the more complex applications, maximising on the versatility of our SMART and NetLink control products.

Telephone: 029 2085 8585

Facsimile: 029 2085 8586

3 YEAR WARRANTY

The three year warranty starts from the date of delivery and includes parts and labour for the first year.

The labour element is subject to full, free and safe access to the equipment as recommended by the CDM regulations.

The remaining two years covers replacement parts only.

NOTE:

Installation & Maintenance of the equipment must be as directed in the instructions provided with the unit.