

1.3 Access for Maintenance

Key for Component location (for figure 3 side access unit and figure 4 bottom access unit)

A	Extract Fan	** regular maintenance may be required (dependant on installed conditions).
B	Condensate tray**	* regular maintenance required.
C	Heater	Other components are unlikely to need attention on a regular basis.
D	Supply Filter*	Access space around the unit is recommended as being a minimum of 600mm.
E	Supply Fan and Heat Exchanger	(see Approved Document FI - 2006 sections 2.6, 2.7).
F	Controls (if fitted)	
G	Extract Filter *	
H	Condensate pipe	

Side access units viewed from below:
Figure 3. Maintenance access is from one side (Control box side). Service access to extract fan is from the opposite side.
Note: All removable access panels incorporate quarter turn fixings which must be fully engaged and secure after maintenance.

Bottom access units viewed from below:
Figure 4. Maintenance access is available via three access panels on the bottom of the unit. Note: All removable access panels incorporate quarter turn fixings which must be fully engaged and secure after maintenance.

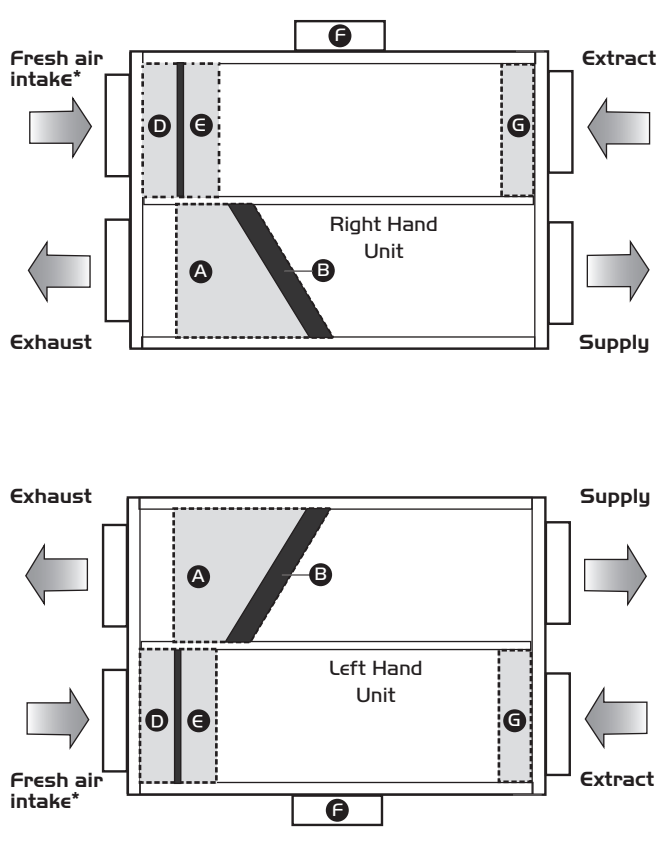
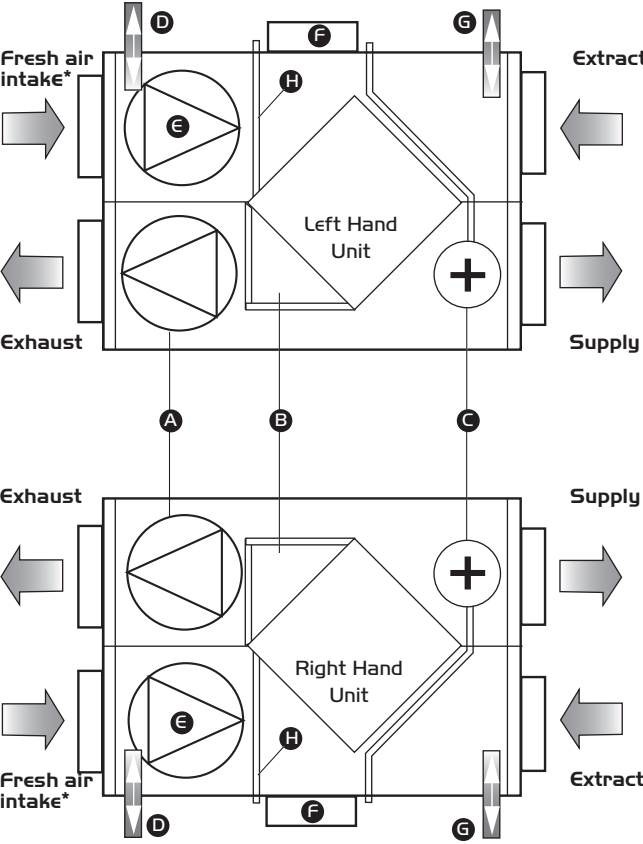

*Ensure the fresh air intake is located well away from the exhaust of this or any other system.

Figure 5. (Viewed from below) Example of access panel removed from bottom access unit for access to A & B (extract fan and condensate drain on right hand unit).

Figure 6. (Viewed from below) Example of access panel removed from bottom access unit for access to D & E (supply fan, supply filter and heat exchanger, drip tray fixings and pipe connection on right hand unit).

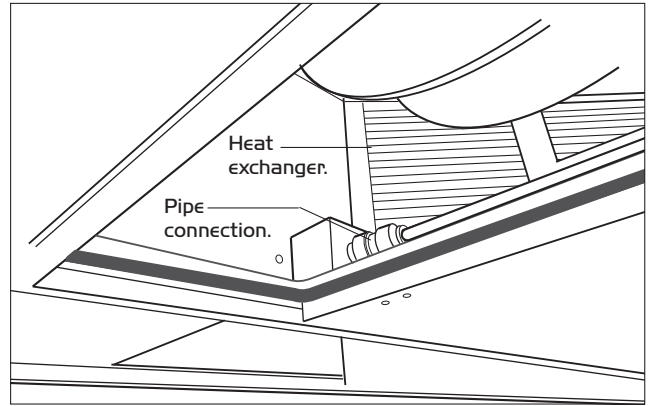
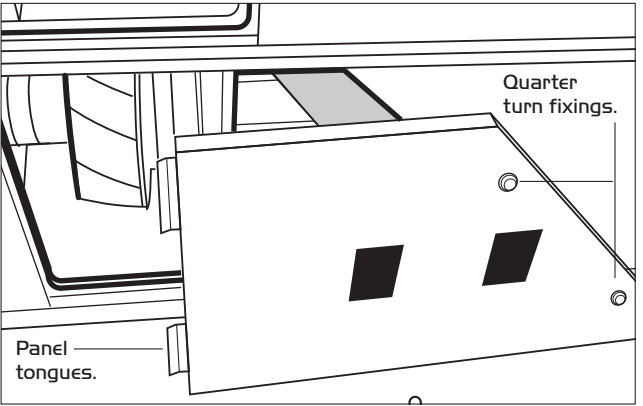

d) Data Cable Installation

A 4-core SELV data cable is used to connect devices. Do not run data cable in the same conduit as the mains cables and ensure there is a 50mm separation between the data cable and other cables. The maximum cable run between any two devices is 300m when it is installed in accordance with the instructions.

Please note that the total data cable length used in any system must be less than 1000m. Keep the number of cable joints to a minimum to ensure the best data transmission efficiency between devices.

e) Maximum Number of Devices

The maximum number of devices (including fans) that can be connected together via the cable is 32, irrespective of their functions.

f) Other Low Voltage Cables

Follow the basic principle (as d). Keep the cable run as short as possible, less than 50 metres. Use screened cable if cable length is more than 2m.

Electrical Details

Fans without Electric Heater		Fans with Electric Heater	
Unit Code	flc (amps)	Unit Code	flc (amps)
XB2-*N/L	1.7	XB2-*E	22
XB3-*N/L	1.9	XB2-*E	22
XB4-*N/L	2.8	XB2-*E	23
XB5-*N/L	3.3	XB2-*E	24

Wiring - for units with Ecosmart Control cont.

Wiring - Unit sizes XB2-5 with Ecosmart fan only control. Figure I3.

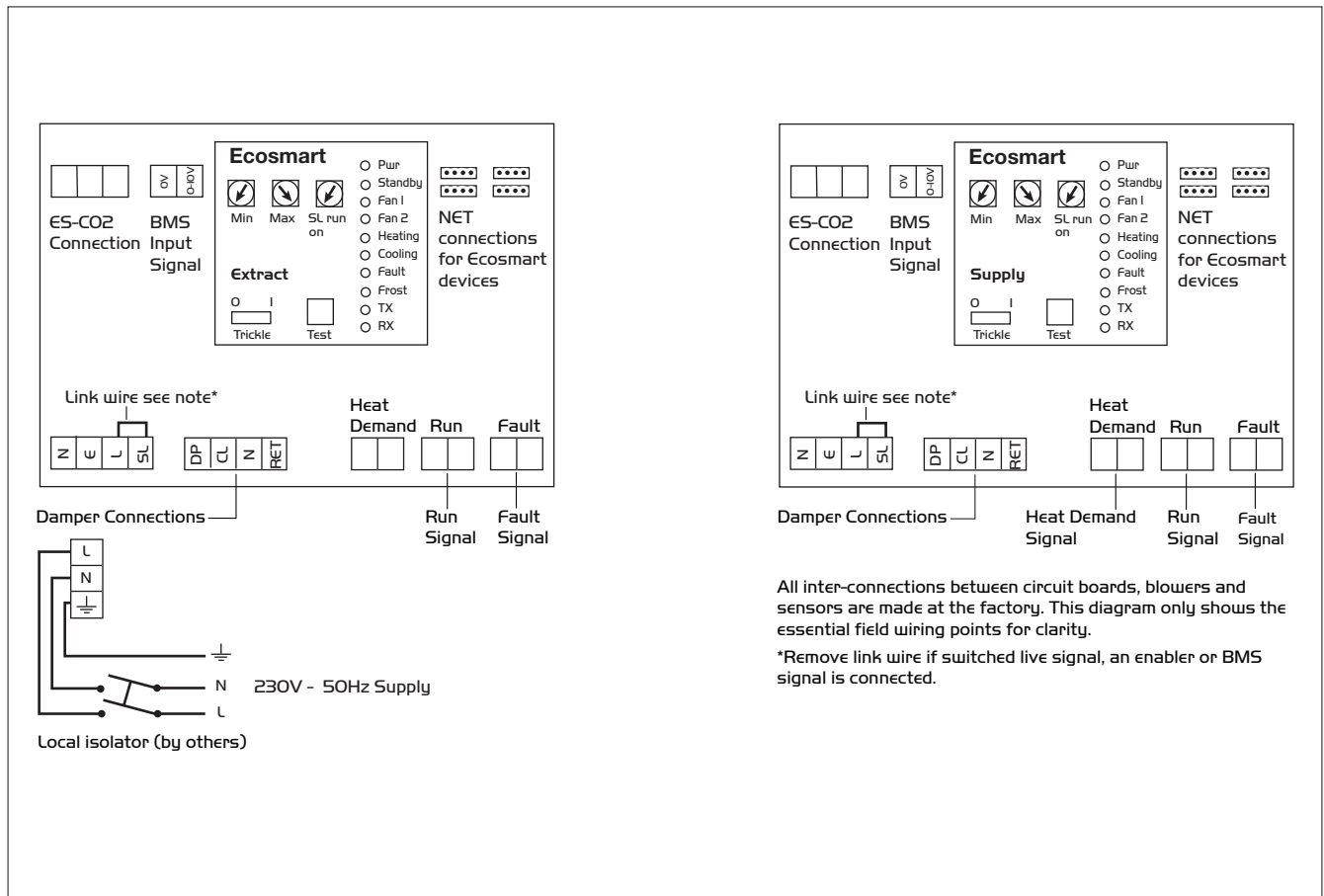

Wiring - for units with Ecosmart Control cont.

Wiring - Unit sizes XB2-5 with Ecosmart control and electric heater. Figure 14.

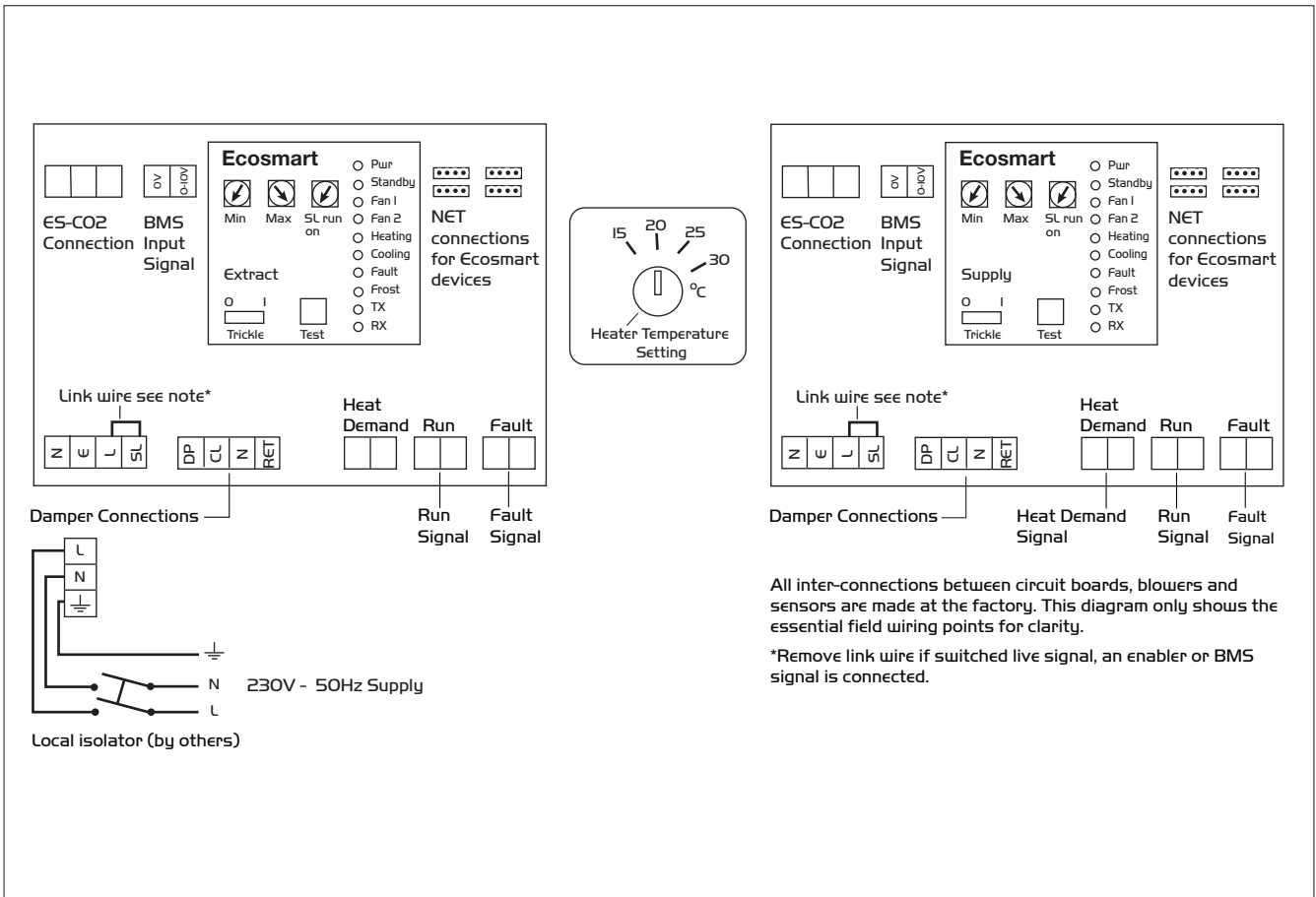

Wiring - Unit sizes XB2-5 with Ecosmart fan and LPHW coil control. Figure 15.

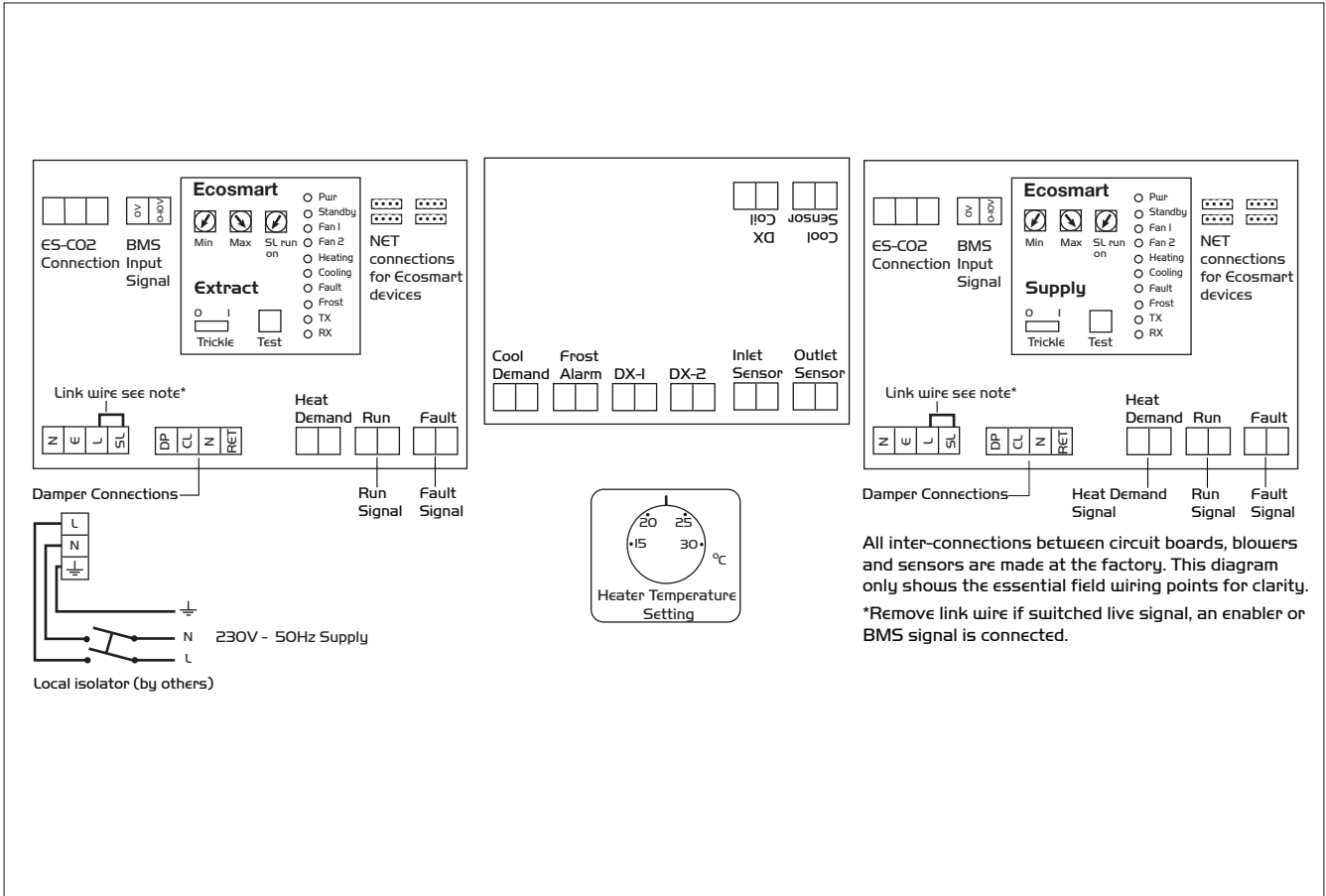

Wiring - for Twinfan units with Ecosmart Control

Wiring - Unit sizes XB2-5T with Ecosmart fan only control. Figure 16.

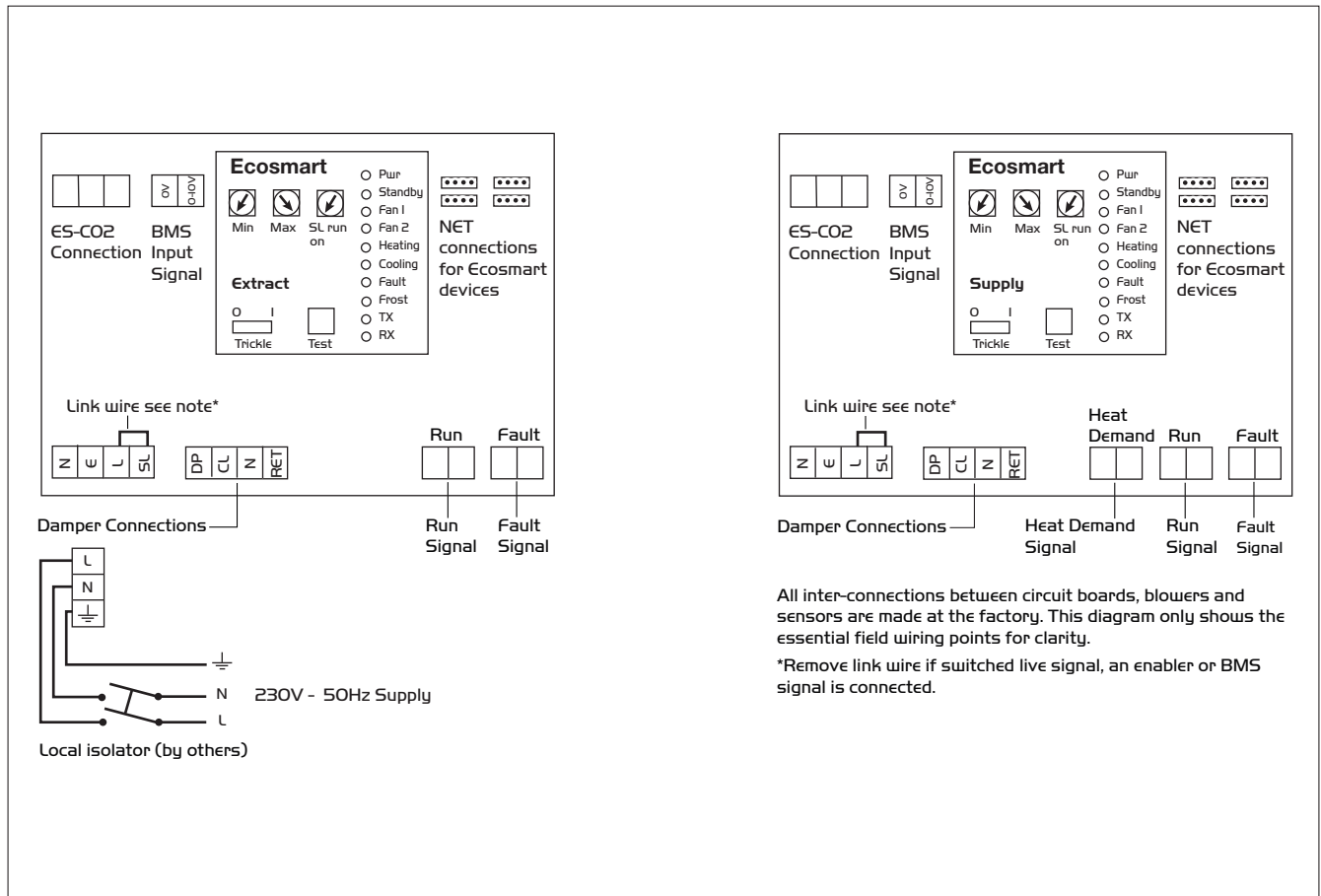

Wiring - Unit sizes XB2-5T with Ecosmart control and electric heater. Figure 17.

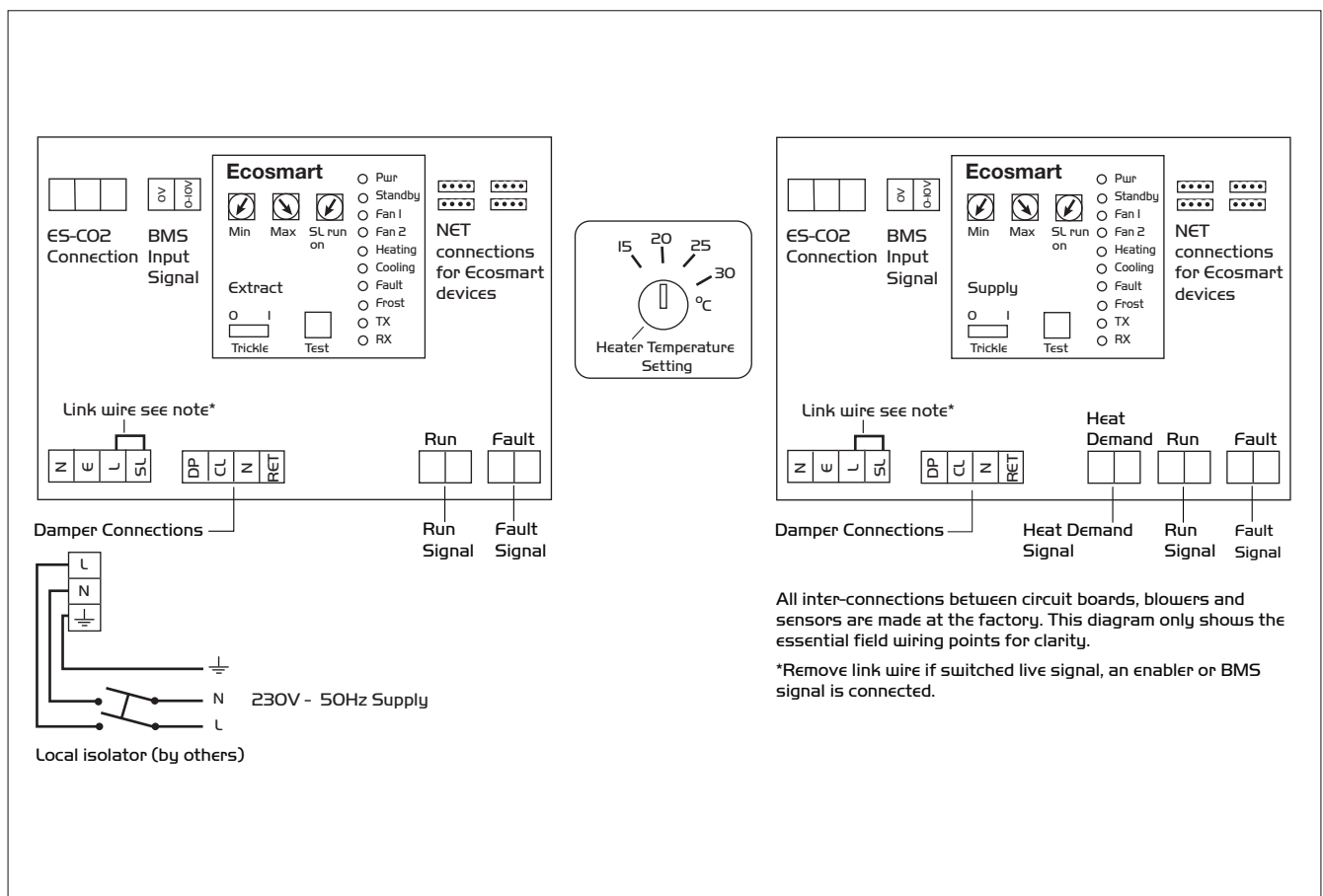

Settings cont.

Setting the minimum trickle airflow (nominal 40%)

i) Repeat the same procedure as for maximum airflow above but without the link wire between supply L and SL terminal. Ensure the trickle switch is in the 'ON' position. Adjustment must be made on the pot marked 'Min'.

ii) Note that the minimum setting (nominally 40%) must be below the maximum setting, otherwise minimum setting will be automatically set to be the same as the maximum.

Setting the overrun time

A switched live of 100-230V at terminal SL will activate the fan. When the switched live signal is removed the fan will overrun for period set by the dial 'SL run on' - adjust the desired overrun time by rotating clockwise.

Setting the trickle ventilation facility

Slide the 'trickle' switch O = Off, I = On. With 'trickle' on and power to unit the fan will run at minimum speed until the switch live signal activates it to boost.

Setting the 'air off' temperature

The adjustment knob is located in the control pack and must be set to the desired 'air off' temperature.

Figure 19.

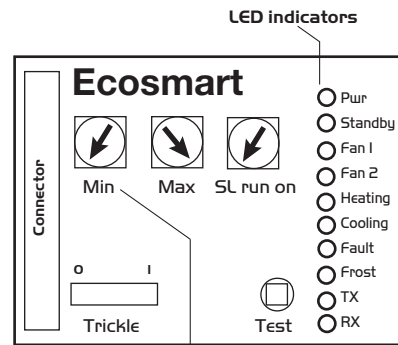

- MIN = Minimum speed adjustment
- MAX = Maximum speed adjustment
- SL Run on = Switched Live Run-On Timer adjustment
- TRICKLE = Selects trickle running: O = off, I = selected
- TEST = Test button

4.0 Wiring - for units supplied without Ecosmart Control

The wiring illustrations below are for the fans, bypass damper and electric heater for units without control.

All wiring is terminated in junction boxes fitted to the specified side of the unit.

It is the installer's responsibility to select and fit the appropriate control equipment to produce the desired output.

Note that any heating/cooling coils fitted are supplied without control valve and actuator.

Electrical Details

Unit size	Fan motor ratings		Electric heater ratings (if fitted)	
	flc	sc	kW	flc
XB2	2 x 0.75A	2 x 3A	4.5kW	18.7A
XB3	2 x 0.75A	2 x 3A	4.5kW	18.7A
XB4	2 x 1.2A	2 x 4.8A	4.5kW	18.7A
XB5	2 x 1.2A	2 x 4.8A	4.5kW	18.7A

Bypass damper rated at 3W, 13mA for all unit sizes.

(Unit sizes XB2-5) Fan wiring.

Two per unit and one per blower.

(Unit sizes XB2-5T) Fan wiring.

Three per unit and one per blower.

(Unit sizes XB2-5) with electric heater

bypass damper and electric heater

wiring.

(Unit sizes XB2-5) Fan only or

with LPHW coil bypass damper

wiring.

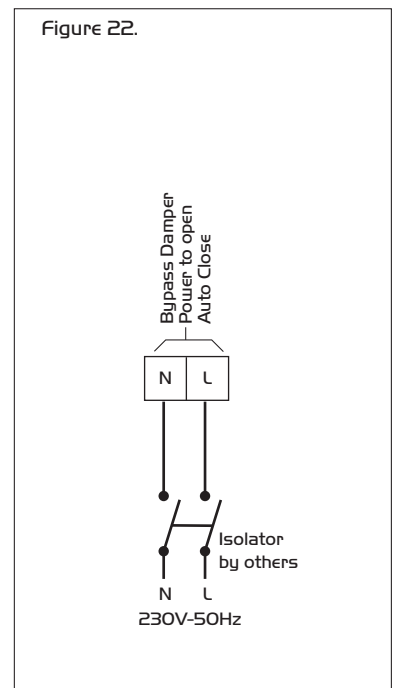
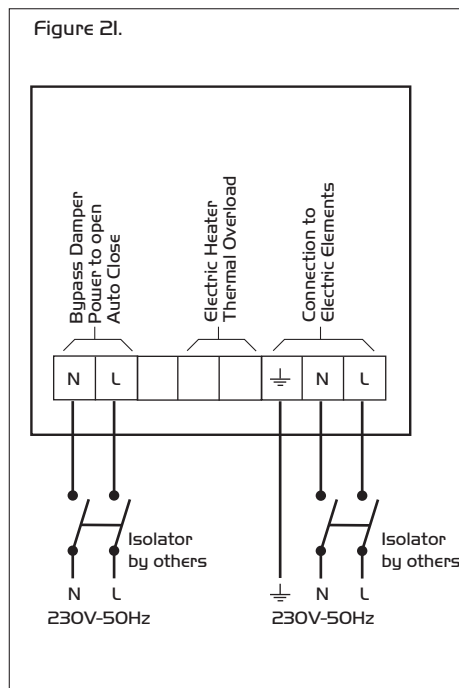
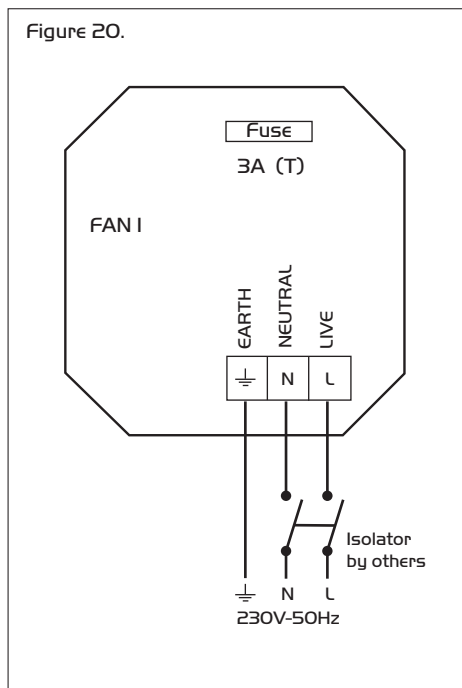

5.0 Maintenance

The first maintenance should be carried out three months after commissioning and thereafter at twelve monthly intervals. These intervals may need to be shortened if the unit is operating in adverse environmental conditions, or in heavily polluted air.

Lubrication

Motors are fitted with sealed for life bearings and do not require any lubrication.

General Cleaning and Inspection

Clean and inspect the exterior of the fan unit and associated controls etc. Remove the access panel from the fan unit, inspect and, if necessary, clean the fan and motor assemblies, heat exchanger and condensate tray, and the interior of the case.

If the unit is heavily soiled it may be more convenient to remove the various assemblies. Check all parts for security and that the impeller rotates freely, taking care not to disturb the balance. Ensure all control components are secure and clean, refit all access doors. Do not use solvents or corrosive agents for cleaning.

Filter care/replacement

The filters inside the unit will require changing on a regular basis. The frequency will depend on the site conditions.

Note: It is important to allow sufficient time for the heater battery (where fitted) to cool down before beginning work. Remove the access panel and withdraw, remove and replace the filters.

Cleaning Control Box and Sensors (if fitted)

Remove covers and carefully clean out interiors as necessary. Check for damage and security of components. Refit covers.

6.0 Replacement of Parts

Should any component need replacing Nuair keep extensive stocks for quick delivery. Ensure that the unit is electrically isolated, before carrying out any work.

When ordering spare parts, please quote the serial number of the unit and the ARC number of the purchase if possible. **(This information will be available on the fan label).**

7.0 Warranty

Units fitted with Ecosmart control carry a 5 year warranty. Units without controls carry a 3 year warranty.

The warranty starts from the day of delivery and includes parts and labour for the first year. The remaining period covers replacement parts only.

This warranty is conditional on planned maintenance being undertaken.

8.0 Service Enquiries

Nuair can assist you in all aspects of service. Our service department will be happy to provide any assistance required, initially by telephone and if necessary arrange for an engineer to call.

**Telephone 029 2085 8585
Fax 029 2085 8586**

DECLARATION OF INCORPORATION AND INFORMATION FOR SAFE INSTALLATION, OPERATION AND MAINTENANCE

We declare that the machinery named below is intended to be assembled with other components to constitute a system of machinery. All parts except for moving parts requiring the correct installation of safety guards comply with the essential requirements of the Machinery Directive. The machinery shall not be put into service until the system has been declared to be in conformity with the provisions of the EC Machinery Directive.

Designation of machinery: XBOXER 2 - 5
Machinery Types: Supply & Extract fans with Heat Recovery
Relevant EC Council Directives: 2006/42/EC (Machinery Directive)
Applied Harmonised Standards: BS EN ISO 12100-1, BS EN ISO 12100-2, EN60204-1, BS EN ISO 9001, BS EN ISO 13857
Applied National Standards: BS848 Parts 1, 2.2 and 5

Note: All standards used were current and valid at the date of signature.

Signature of manufacture representatives:

Name:	Position:	Date:
1) C. Biggs 	Technical Director	26. 07. 11
2) A. Jones 	Manufacturing Director	26. 07. 11

INFORMATION FOR SAFE INSTALLATION, OPERATION AND MAINTENANCE OF NUAIRE VENTILATION EQUIPMENT

To comply with EC Council Directives 2006/42/EC Machinery Directive and 2014/30/EU (EMC).

To be read in conjunction with the relevant Product Documentation (see 2.1)

1.0 GENERAL

1.1 The equipment referred to in this Declaration of Incorporation is supplied by Nuairé to be assembled into a ventilation system which may or may not include additional components.

The entire system must be considered for safety purposes and it is the responsibility of the installer to ensure that all of the equipment is installed in compliance with the manufacturers recommendations and with due regard to current legislation and codes of practice.

2.0 INFORMATION SUPPLIED WITH THE EQUIPMENT

2.1 Each item of equipment is supplied with a set of documentation which provides the information required for the safe installation and maintenance of the equipment. This may be in the form of a Data sheet and/or Installation and Maintenance instruction.

2.2 Each unit has a rating plate attached to its outer casing. The rating plate provides essential data relating to the equipment such as serial number, unit code and electrical data. Any further data that may be required will be found in the documentation. If any item is unclear or more information is required, contact Nuairé.

2.3 Where warning labels or notices are attached to the unit the instructions given must be adhered to.

3.0 TRANSPORTATION, HANDLING AND STORAGE

3.1 Care must be taken at all times to prevent damage to the equipment. Note that shock to the unit may result in the balance of the impeller being affected.

3.2 When handling the equipment, care should be taken with corners and edges and that the weight distribution within the unit is considered. Lifting gear such as slings or ropes must be arranged so as not to bear on the casing.

3.3 Equipment stored on site prior to installation should be protected from the weather and steps taken to prevent ingress of contaminants.

4.0 OPERATIONAL LIMITS

4.1 It is important that the specified operational limits for the equipment are adhered to e.g. operational air temperature, air borne contaminants and unit orientation.

4.2 Where installation accessories are supplied with the specified equipment eg. wall mounting brackets. They are to be used to support the equipment only. Other system components must have separate provision for support.

4.3 Flanges and connection spigots are provided for the purpose of joining to duct work systems. They must not be used to support the ductwork.

5.0 INSTALLATION REQUIREMENTS

In addition to the particular requirements given for the individual product, the following general requirements should be noted.

5.1 Where access to any part of equipment which moves, or can become electrically live are not prevented by the equipment panels or by fixed installation detail (eg ducting), then guarding to the appropriate standard must be fitted.

5.2 The electrical installation of the equipment must comply with the requirements of the relevant local electrical safety regulations.

5.3 For EMC all control and sensor cables should not be placed within 50mm or on the same metal cable tray as 230V switched live, lighting or power cables and any cables not intended for use with this product.

6.0 COMMISSIONING REQUIREMENTS

6.1 General pre-commissioning checks relevant to safe operation consist of the following:

Ensure that no foreign bodies are present within the fan or casing.

Check electrical safety. e.g. Insulation and earthing.

Check guarding of system.

Check operation of Isolators/Controls.

Check fastenings for security.

6.2 Other commissioning requirements are given in the relevant product documentation.

7.0 OPERATIONAL REQUIREMENTS

7.1 Equipment access panels must be in place at all times during operation of the unit, and must be secured with the original fastenings.

7.2 If failure of the equipment occurs or is suspected then it should be taken out of service until a competent person can effect repair or examination. (Note that certain ranges of equipment are designed to detect and compensate for fan failure).

8.0 MAINTENANCE REQUIREMENTS

8.1 Specific maintenance requirements are given in the relevant product documentation.

8.2 It is important that the correct tools are used for the various tasks required.

8.3 If the access panels are to be removed for any reason the electrical supply to the unit must be isolated.

8.4 A minimum period of two minutes should be allowed after electrical disconnection before access panels are removed. This will allow the impeller to come to rest.

NB: Care should still be taken however since airflow generated at some other point in the system can cause the impeller to "windmill" even when power is not present.

8.5 Care should be taken when removing and storing access panels in windy conditions.



Western Industrial Estate
Caerphilly United Kingdom
CF83 1NA
T: 029 2085 8200
F: 029 2085 8300
E: ahu@nuaire.co.uk
W: www.nuaire.co.uk