

NUAIRE

INSTALLATION

Neonaire NE20T Shower Fan & Light

NUAIRE

NuAire Limited
Western Industrial Estate
Caerphilly, United Kingdom
CF83 1XH
Telephone: 029 2088 5911
Facsimile: 029 2088 7033
Email: info@nuaire.co.uk
www.nuaire.co.uk



The EMC directive: 89/336/EEC
with modification 92/31/EEC
The low voltage directive 73/23/EEC

Leaflet 671125

SEPTEMBER 2001

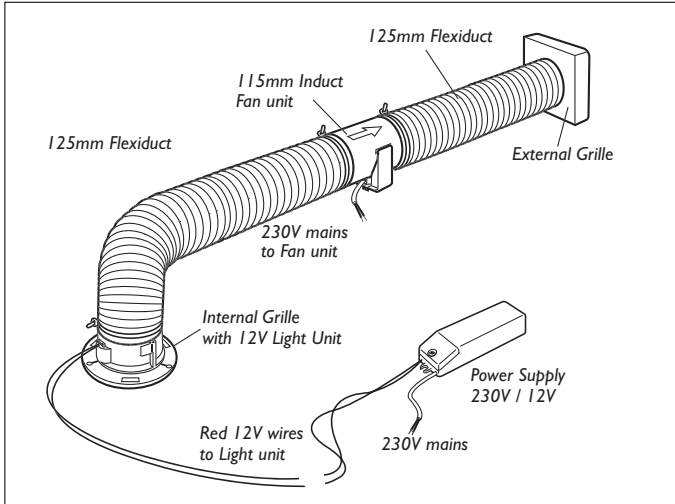

General Notes

If the fan is installed in a room containing a fuel burning appliance of a non-balanced flue design, it is the responsibility of the installer to ensure that sufficient replacement air is provided to prevent products of combustion from being drawn down the flue when the fan/ light unit is operating.

The unit should not be sited where it would be subject to a direct source of heat in excess of 40°C.

Once fitted into ceiling void or loft space, do not cover light body, fan or 12V power supply unit with any insulating materials.

Minimum void height when fitting into ceiling space and minimum distance for light is 200mm.

ISOLATION

Note that the unit must be provided with a means of isolation (by others) for maintenance purposes etc. An RCD trip device must be included between the power supply unit and the mains if the unit is fitted in zone 1 as defined in IEE regulations.

Refer to Wiring Instructions overleaf.

Installation IMPORTANT

The installation must be carried out by qualified personnel in accordance with the appropriate authority and conforming to all statutory and governing regulations eg. IEE, CIBSE, COHSE etc.

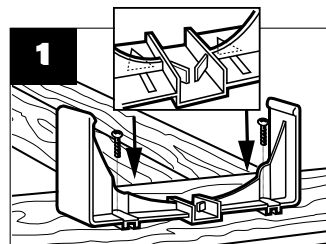

Secure the fan holder to a joist using two No. 6 screws.

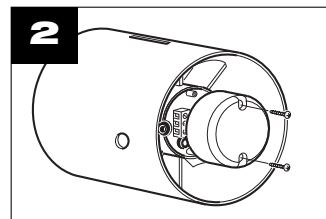

To wire the induct fan, first remove the wiring cover.

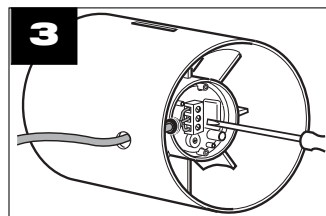

Bring the mains supply cable through the fan case and internal grommet. Wire up the fan as shown in the wiring diagram.

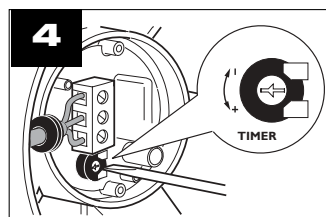

The run-on-timer is adjustable from 1 - 25 minutes. Factory set at midway point. Replace the wiring cover.

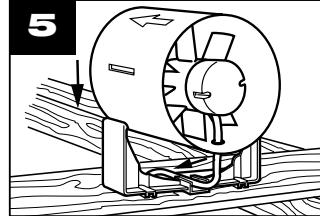

Clip the fan into the fan holder, making sure it is secure. Push the cable into the grip provided in the base.

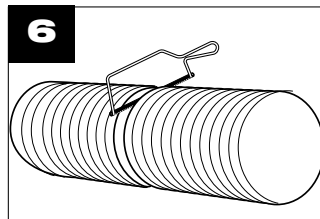

Cut the flexible ducting into the lengths required.

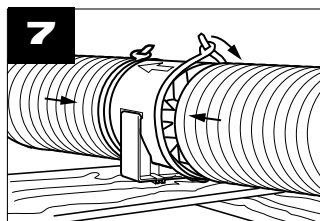

Secure the ducting to the fan using the ties provided.

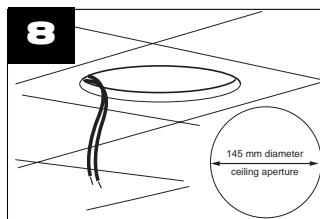

Cut a hole in the ceiling to the size indicated and thread through the two red 12V Power Supply unit cables.

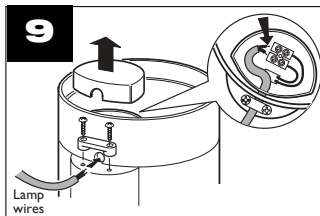

To wire in the light, lift off the cover. Loosen the clamp on the case side. Bring in the two red 12V cables and wire as shown.

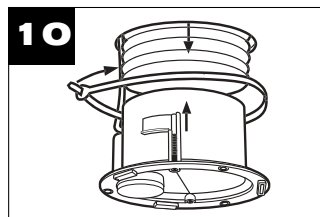

Bring ducting down through ceiling and attach it to the Light Unit with one of the ties provided.

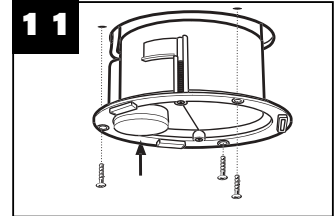

Remove the finisher. Mark and plug three ceiling holes using the holes on the light unit. Secure using three No. 6 c/s screws

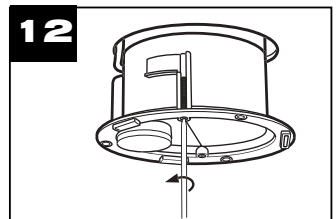

Alternatively, attach the fixing fingers with long screws provided to the light unit as shown

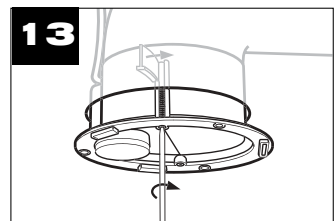

Push the light unit through the ceiling and twist the fingers outwards

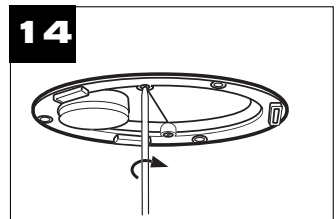

Then tighten the fixing fingers against the ceiling (do not overtighten). To fit the lamp see overleaf. Clip on the internal finisher

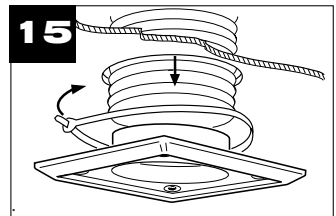

Prepare hole through wall or soffit. Push through unattached end of the flexiduct attach it to the grille spigot using the tie.

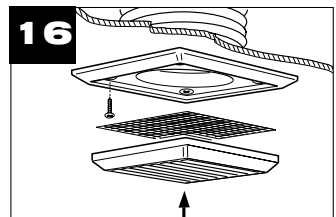

Fix back plate using plugs and screws. Snap on external grille. (If through a wall, ensure the grille louvres slope downwards).

DIMENSIONS

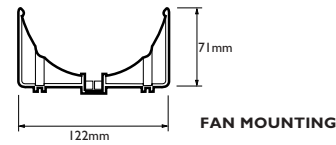
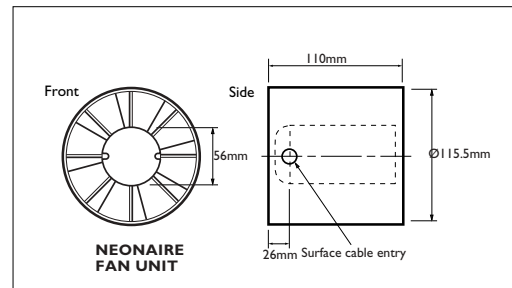
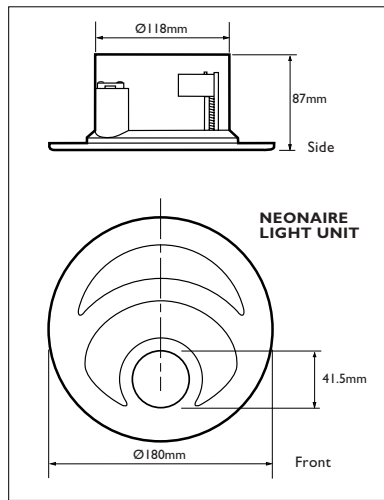

WIRING

WARNING!

Isolate electricity supply before starting work.

- The unit must be wired and installed in accordance with IEE or local regulations by a suitably qualified electrician. The fan must only be connected using flexible supply cord.
- The unit is double insulated and does not require earth connection.
- The unit must be connected to the double pole isolating switch having a contact separation of at least 3mm at each pole and fitted with a 3A fuse.
- The power supply unit must not be sited within reach of a person using a bath or shower nor within a shower cubicle/ enclosure.
- The Power supply unit is supplied with flying leads. The two red 12V leads should be connected directly to the lamp terminals within the lamp body (see 5 overleaf).
- **The mains cable from the Power supply unit should be connected via an RCD protection device** to a mains voltage junction box or similar (supplied by others). See wiring diagram.
- Connect only one light unit per Power supply unit.

IMPORTANT!
DO NOT OPERATE THE LIGHT WITHOUT THE FAN RUNNING.

Specifications

Fan unit: 230V 1ph 50Hz. Watts 23W, IP44.

Light unit: 12V 1ph 50Hz. IP44

Cable size: 1.00mm² max. (flexible only).

Lamp: 12V dichroic rated at 20W
36° beam angle.
GE Lighting type M269

Lamp replacement

WARNING!

Isolate electricity supply before starting work.

- Remove the internal finisher by pulling down.
- Remove the lamp lens and old lamp by pulling down.
- Fit lamp by pushing up into the lamp holder.
- Push up lamp lens and internal finisher.

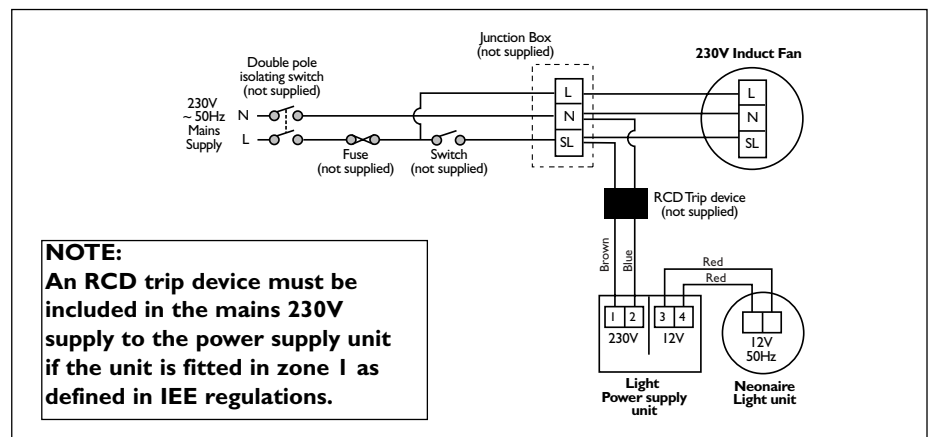

MAINTENANCE

CLEANING

LIGHT UNIT

Electrically isolate the unit before commencing any work. Remove the internal finisher by pulling down. Wash in warm water. The lamp body may be cleaned using a brush or damp cloth prior to replacing the finisher.

FAN UNIT

Electrically isolate the unit before commencing any work. To gain access to both sides of the impeller/motor it will be necessary to temporarily remove the unit from the installation. Lightly brush away any internal build up of dust. Do not use any solvents or immerse the unit in water. Check the impeller rotates freely. We suggest the unit is inspected/cleaned at once yearly in general use.

3 Year Warranty

The three year warranty starts from the date of delivery and includes parts and labour for the first year. The labour element is subject to full, free and safe access to the equipment as recommended by the CDM regulations. The remaining two years covers replacement parts only.

NOTE:

Installation & Maintenance of the equipment must be as directed in the instructions provided with the unit.

Service

In the event of a breakdown contact our Service Department. We will be happy to give you more information .

Telephone: 02920 858585

Facsimile: 02920 858586

NUAIRE

NuAire Limited

Western Industrial Estate

Caerphilly, United Kingdom CF83 1XH

Telephone: 029 2088 5911 Facsimile: 029 2088 7033

Email: info@nuaire.co.uk www.nuaire.co.uk